

Manganese Dioxide Lithium Coin Batteries: Individual Specifications

CR2012

☒ Dimensions(mm)

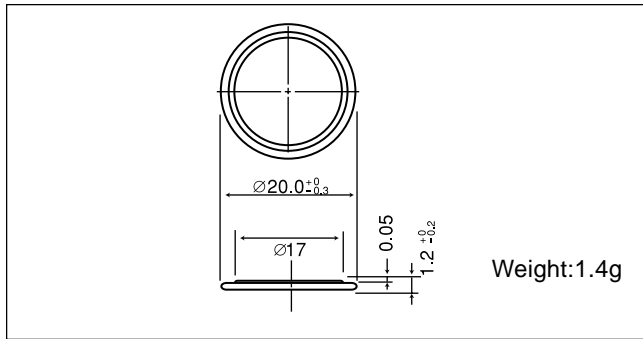

☒ Specification

Nominal voltage (V)	3
Nominal capacity (mAh)	55
Continuous standard load (mA)	0.1
Operating temperature (C)	-30 ~ +60

☒ Temperature Characteristics

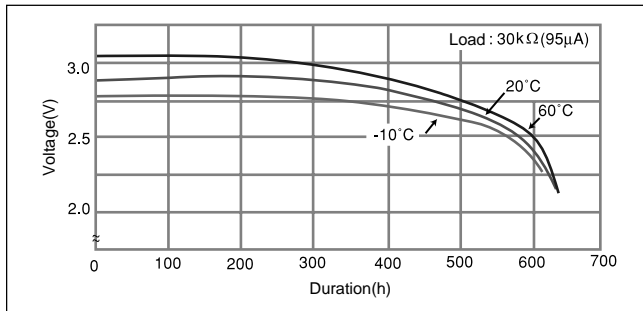

☒ Operating voltage vs. load resistance (voltage at 50% discharge depth)

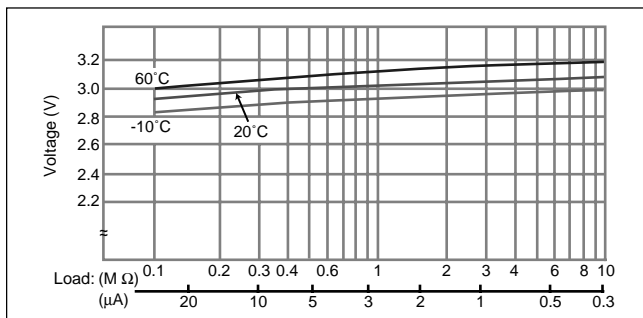

☒ Capacity vs. load resistance

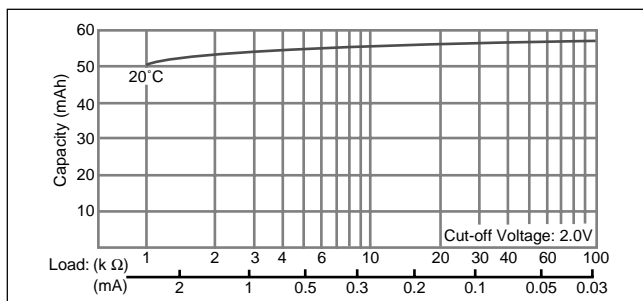

CR2016

☒ Dimensions(mm)

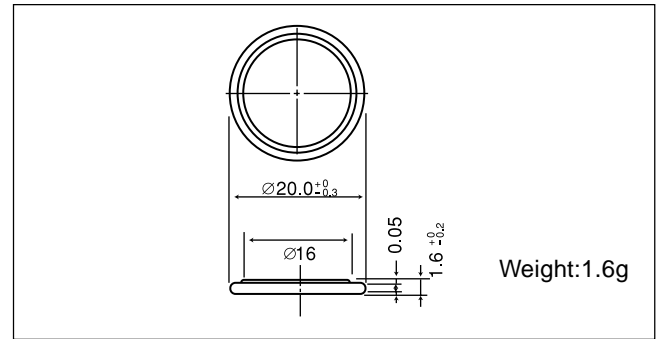

☒ Specification

Nominal voltage (V)	3
Nominal capacity (mAh)	90
Continuous standard load (mA)	0.1
Operating temperature (C)	-30 ~ +60

☒ Temperature Characteristics

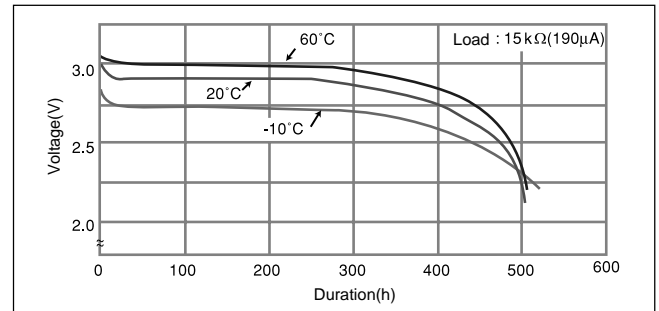

☒ Operating voltage vs. load resistance (voltage at 50% discharge depth)

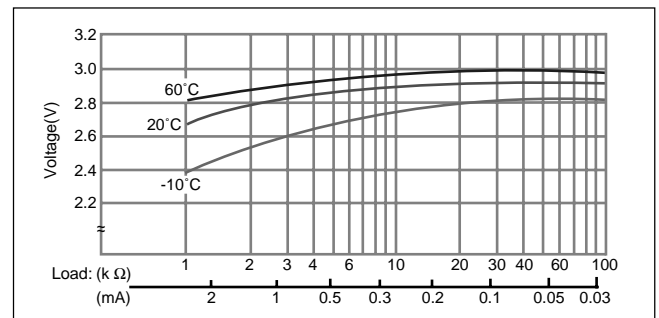

☒ Capacity vs. load resistance

