

Ø3.5 Earphone Jack Conn.

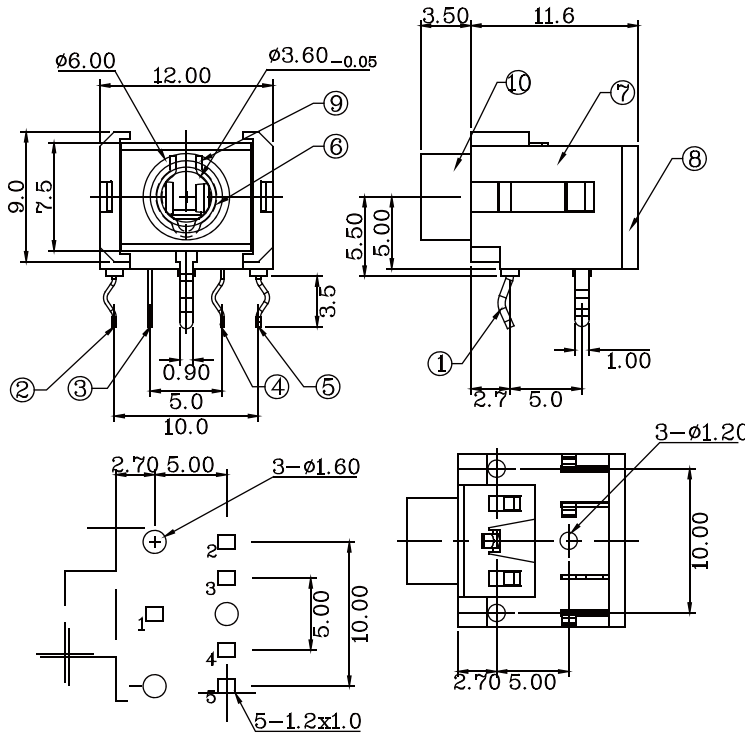

Recommended PCB Layout
(PCB TOLERANCE ±0.05)

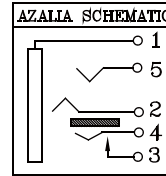

Table

NO.	EPJ35-2509FP-05X-L	PANTONE
PK	PINK	701C
U	BLACK	
W	LIME	577C
Y	YELLOW	123C
OR	ORANGE	157C
LU	LIGHT BLUE	284C

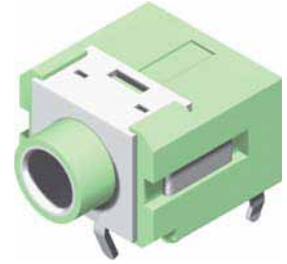

NO.	NAME	MATERIAL	FINISH	Q'TY
1	PIN 1	C.R.S. 0.50	TIN PLATED	1
2	PIN 2	PHOS.BRONZE 0.25	TIN PLATED	1
3	PIN 3	PHOS.BRONZE 0.25	SILVER PLATED	1
4	PIN 4	PHOS.BRONZE 0.25	SILVER PLATED	1
5	PIN 5	PHOS.BRONZE 0.30	TIN PLATED	1
6	BUSHING	BRASS	NICKEL PLATED	1
7	HOUSING	NYLON PA66	SEE COLOR	1
8	BACK COVER	PBT G.F.	SEE COLOR	1
9	SPRING WIRE	BRASS	SILVER PLATED	1
10	TUBE	PBT G.F.	SEE COLOR	1

Part No.:EPJ35-2509FP-05T-L
See Table

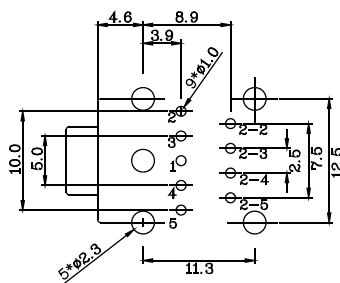
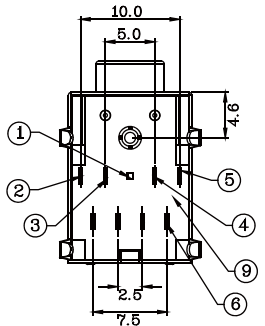
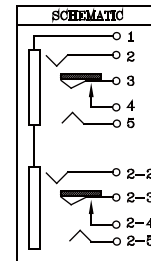
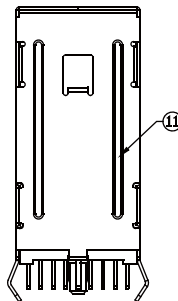
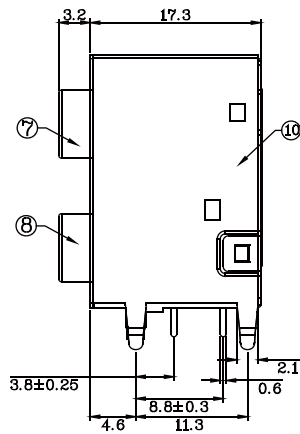
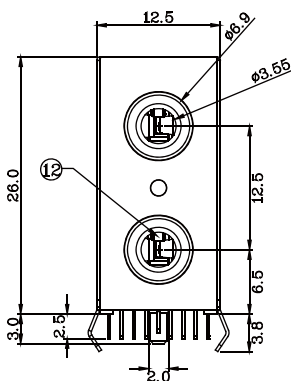

Recommended PCB Layout
(PCB TOLERANCE ±0.05)

MODEL NO.	EPJ35-2511P-09X-L (COLOR & PANTONE)			
	A	B	C	D
HOUSING TOP	BLACK	LIME, 577C	PINK, 701C	LIME, 577C
HOUSING BOTTOM		PINK, 701C	LIME, 577C	LIGHT BLUE, 284C

NO.	NAME	MATERIAL	FINISH	Q'TY
1	GROUND TERM	PHOS.BRONZE 0.50	TIN PLATED	1
2	SPRING TERMINAL	PHOS.BRONZE 0.25	TIN PLATED	2
3	SPRING TERMINAL	PHOS.BRONZE 0.25	SILVER PLATED	2
4	SPRING TERMINAL	PHOS.BRONZE 0.25	SILVER PLATED	2
5	SPRING TERMINAL	PHOS.BRONZE 0.30	TIN PLATED	2
6	TERMINAL	BRASS 0.3mm	TIN PLATED	4
7	TOP HOUSING	NYLON PA66(ASVO)	SEE COLOR	1
8	BOTTOM HOUSING	NYLON PA66(ASVO)	SEE COLOR	1
9	BOTTOM COVER	PBT G.F.	BLACK	1
10	FRONT SHEEL	SPCC 0.3mm	NICKEL PLATED	1
11	BACK SHEEL	BRASS 0.3mm	NICKEL PLATED	1
12	GROUND TERM	PHOS.BRONZE 0.25	TIN PLATED	2

Part No.:EPJ35-2511P-09T-L
See Table