

# 1SS5004WS

## Silicon Epitaxial Planar Diode

High Voltage Switching Diode

### Features

- Fast switching speed
- High conductance
- High reverse breakdown voltage rating

### PINNING

PIN	DESCRIPTION
1	Cathode
2	Anode

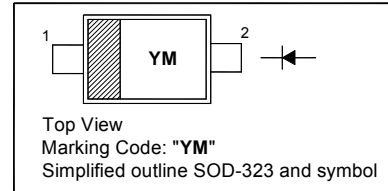

### Absolute Maximum Ratings ( $T_a = 25\text{ }^\circ\text{C}$ )

Parameter	Symbol	Value	Unit
Repetitive Peak Reverse Voltage	$V_{RRM}$	400	V
Reverse Voltage	$V_R$	350	V
Continuous Forward Current	$I_F$	225	mA
Repetitive Peak Forward Current	$I_{FRM}$	625	mA
Non-Repetitive Peak Forward Surge Current (1 ms)	$I_{FSM}$	2	A
Power Dissipation	$P_d$	350	mW
Junction Temperature	$T_j$	150	$^\circ\text{C}$
Storage Temperature Range	$T_{stg}$	- 65 to + 150	$^\circ\text{C}$

### Characteristics at $T_a = 25\text{ }^\circ\text{C}$

Parameter	Symbol	Min.	Max.	Unit
Forward Voltage at $I_F = 20\text{ mA}$ at $I_F = 100\text{ mA}$ at $I_F = 200\text{ mA}$	$V_F$	- - -	0.87 1 1.25	V
Reverse Current at $V_R = 240\text{ V}$	$I_R$	-	100	nA
Reverse Breakdown Voltage at $I_R = 150\text{ }\mu\text{A}$	$V_{(BR)R}$	400	-	V
Total Capacitance at $V_R = 0$ , $f = 1\text{ MHz}$	$C_T$	-	5	pF
Reverse Recovery Time at $I_F = I_R = 30\text{ mA}$ , $i_{tr} = 3\text{ mA}$ , $R_L = 100\text{ }\Omega$	$t_{rr}$	-	100	ns

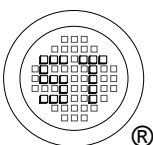

**SEMTECH ELECTRONICS LTD.**  
Subsidiary of Sino-Tech International (BVI) Limited



Dated : 25/09/2009

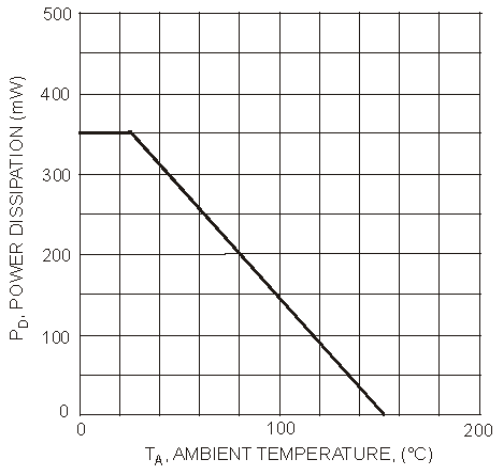

Fig. 1 Power Derating Curve, Total Package

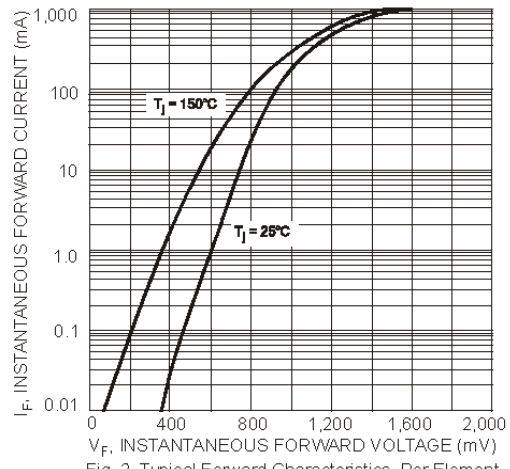

Fig. 2 Typical Forward Characteristics, Per Element

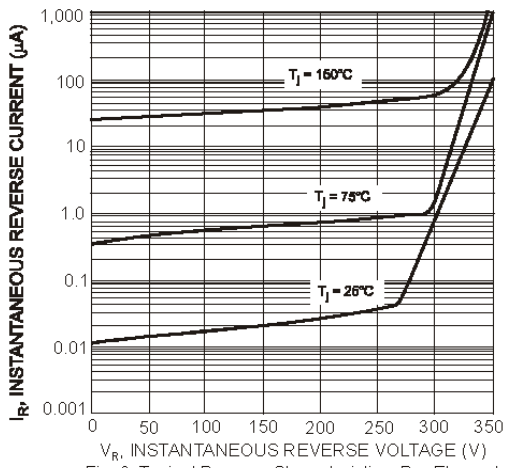

Fig. 3 Typical Reverse Characteristics, Per Element

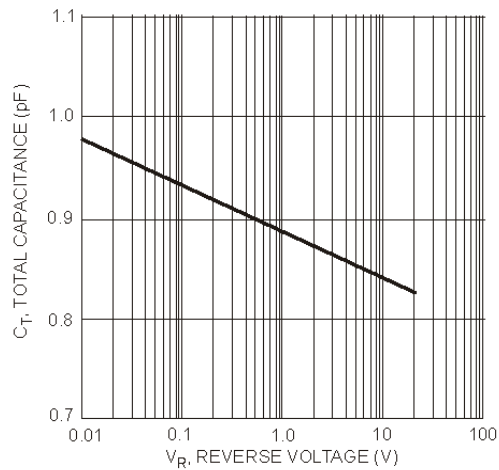
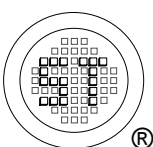

Fig. 4 Total Capacitance vs. Reverse Voltage, Per Element



## PACKAGE OUTLINE

Plastic surface mounted package; 2 leads

SOD-323

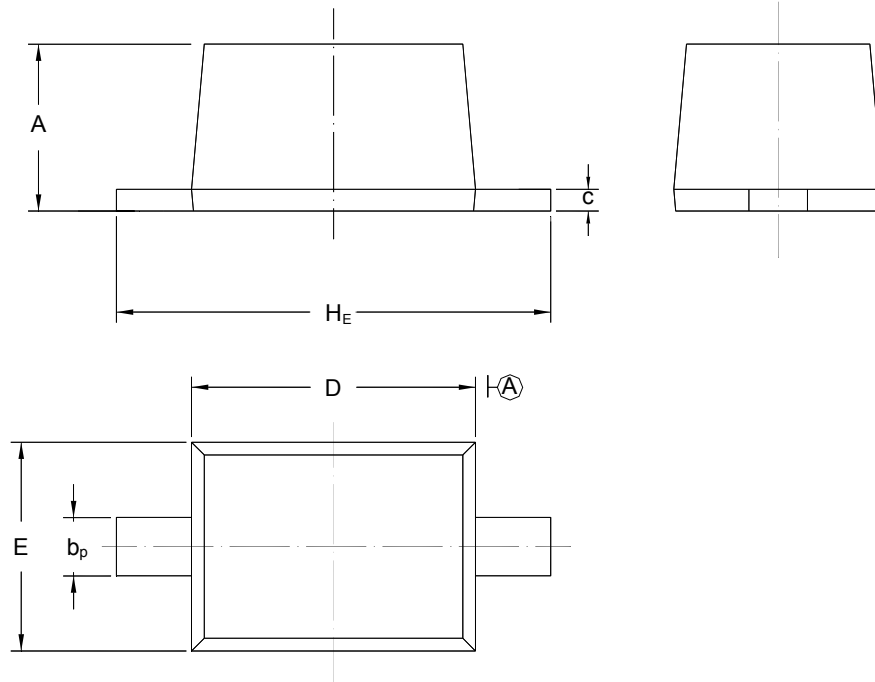

UNIT	A	b <sub>p</sub>	C	D	E	H <sub>E</sub>
mm	1.10 0.80	0.40 0.25	0.15 0.10	1.80 1.60	1.35 1.15	2.80 2.30

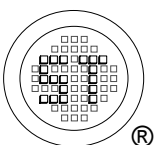

**SEMTECH ELECTRONICS LTD.**  
Subsidiary of Sino-Tech International (BVI) Limited



Dated : 25/09/2009