

# 1ST112WS

## Silicon Epitaxial Planar Switching Diode

### PINNING

PIN	DESCRIPTION
1	Cathode
2	Anode

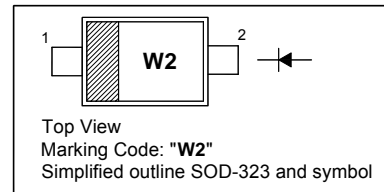

### Absolute Maximum Ratings ( $T_a = 25\text{ }^\circ\text{C}$ )

Parameter	Symbol	Value	Unit
Peak Reverse Voltage	$V_{RM}$	40	V
Reverse Voltage	$V_R$	40	V
Average Forward Current	$I_{F(AV)}$	200	mA
Peak Forward Current	$I_{FM}$	600	mA
Non-Repetitive Peak Forward Surge Current ( $t = 1\text{ s}$ )	$I_{FSM}$	1	A
Junction Temperature	$T_j$	150	$^\circ\text{C}$
Storage Temperature Range	$T_{stg}$	- 55 to + 150	$^\circ\text{C}$

### Characteristics at $T_a = 25\text{ }^\circ\text{C}$

Parameter	Symbol	Max.	Unit
Forward Voltage at $I_F = 200\text{ mA}$	$V_F$	1.1	V
Reverse Current at $V_R = 15\text{ V}$ at $V_R = 35\text{ V}$	$I_R$	50 500	nA
Total Capacitance at $V_R = 0\text{ V}$ , $f = 1\text{ MHz}$	$C_T$	4	pF
Reverse Recovery Time at $V_R = 6\text{ V}$ , $I_F = 10\text{ mA}$ , $I_{rr} = 0.1 \cdot I_R$ , $R_L = 100\ \Omega$	$t_{rr}$	10	ns

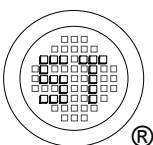

**SEMTECH ELECTRONICS LTD.**  
Subsidiary of Sino-Tech International (BVI) Limited



Dated : 15/06/2009

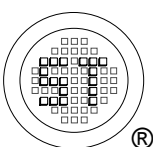
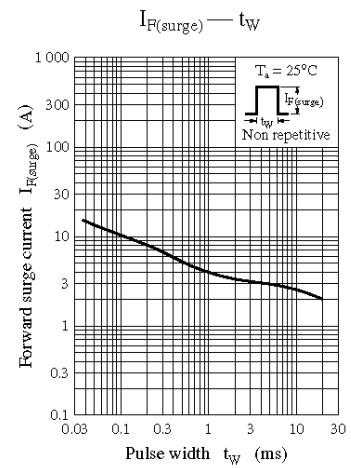
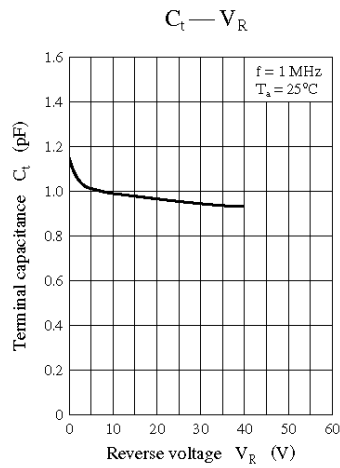
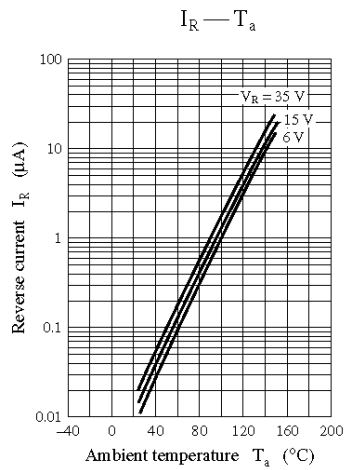
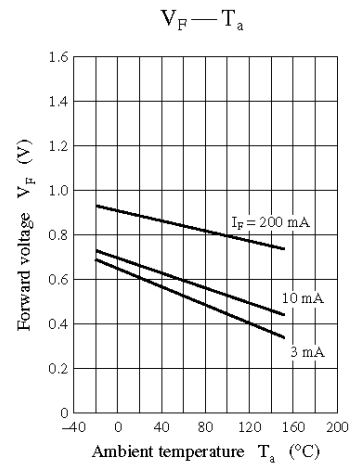
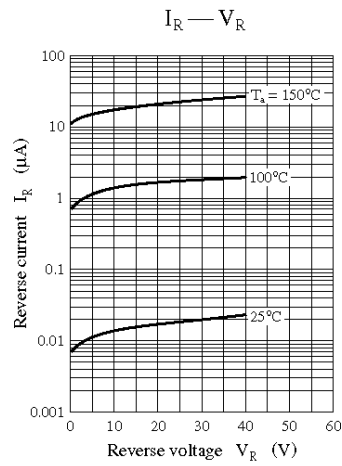
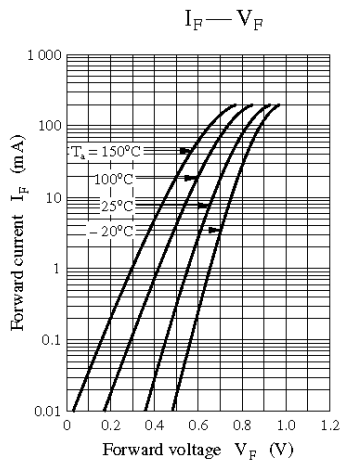

**SEMTECH ELECTRONICS LTD.**  
 Subsidiary of Sino-Tech International (BVI) Limited



# 1ST112WS

## PACKAGE OUTLINE

Plastic surface mounted package; 2 leads

SOD-323

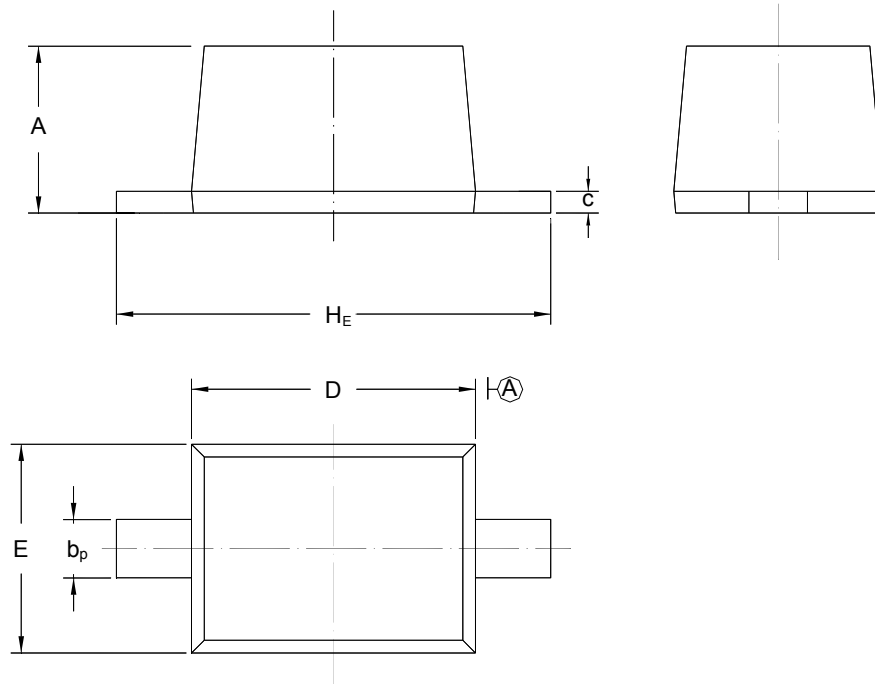

UNIT	A	b <sub>p</sub>	C	D	E	H <sub>E</sub>
mm	1.10 0.80	0.40 0.25	0.15 0.10	1.80 1.60	1.35 1.15	2.80 2.30

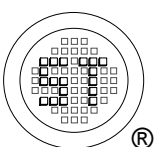

**SEMTECH ELECTRONICS LTD.**  
Subsidiary of Sino-Tech International (BVI) Limited



Dated : 15/06/2009