

BAW56WS

Silicon Epitaxial Planar Switching Diode

PINNING

PIN	DESCRIPTION
1	Cathode
2	Anode

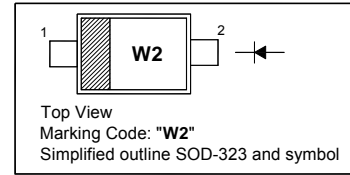

Absolute Maximum Ratings ($T_a = 25\text{ }^\circ\text{C}$)

Parameter	Symbol	Value	Unit
Repetitive Peak Reverse Voltage	V_{RRM}	85	V
Reverse Voltage	V_R	75	V
Continuous Forward Current	I_F	125	mA
Repetitive Peak Forward Current	I_{FRM}	450	mA
Non-repetitive Peak Forward Surge Current	I_{FSM}	at $t = 1\text{ s}$ 0.5	A
		at $t = 1\text{ ms}$ 1	
		at $t = 1\text{ }\mu\text{s}$ 4	
Power Dissipation	P_{tot}	250	mW
Junction Temperature	T_j	150	$^\circ\text{C}$
Storage Temperature Range	T_{stg}	- 65 to + 150	$^\circ\text{C}$

Characteristics at $T_a = 25\text{ }^\circ\text{C}$

Parameter	Symbol	Max.	Unit
Forward Voltage	V_F	at $I_F = 1\text{ mA}$ 715	mV
at $I_F = 10\text{ mA}$ 855		mV	
at $I_F = 50\text{ mA}$ 1		V	
at $I_F = 150\text{ mA}$ 1.25		V	
Reverse Current	I_R	at $V_R = 25\text{ V}$ 30	nA
at $V_R = 75\text{ V}$ 1		μA	
at $V_R = 25\text{ V}, T_j = 150\text{ }^\circ\text{C}$ 30		μA	
at $V_R = 75\text{ V}, T_j = 150\text{ }^\circ\text{C}$ 50		μA	
Diode Capacitance	C_d	2	pF
Reverse Recovery Time	t_{rr}	4	ns
at $I_F = 10\text{ mA}, I_R = 10\text{ mA}, R_L = 100\text{ }\Omega$			

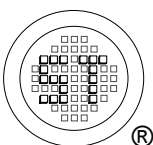

SEMTECH ELECTRONICS LTD.
Subsidiary of Sino-Tech International (BVI) Limited



Dated : 15/06/2009

BAW56WS

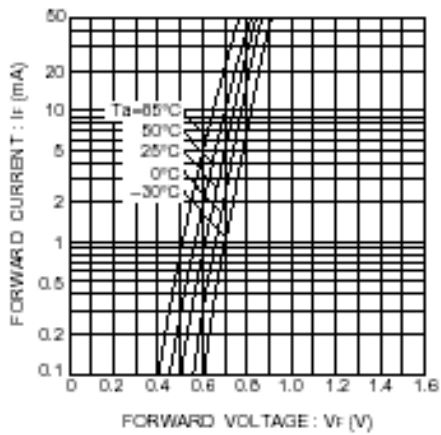

Forward characteristics

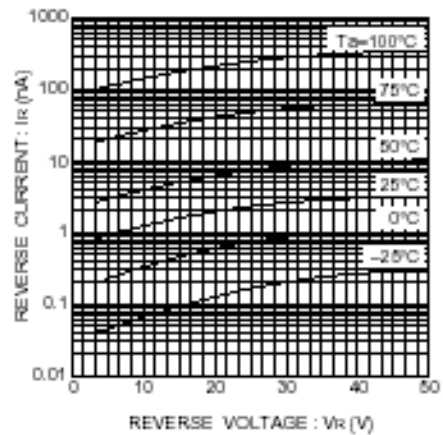

Reverse characteristics

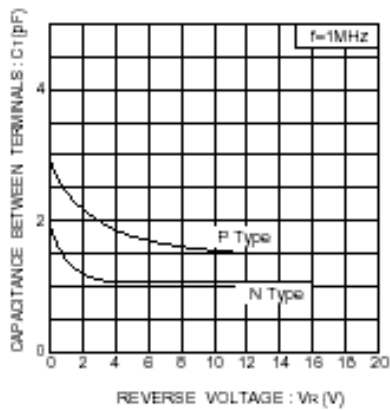

Capacitance between terminals characteristics

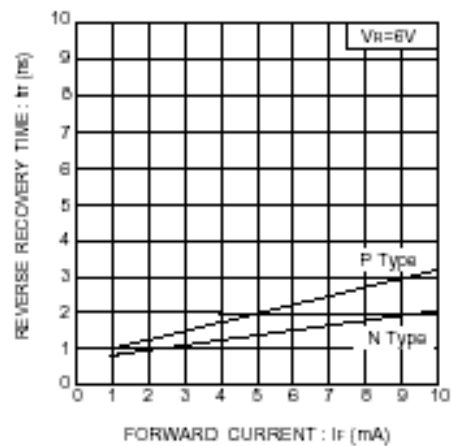

Reverse recovery time

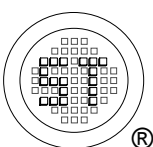

SEMTECH ELECTRONICS LTD.
Subsidiary of Sino-Tech International (BVI) Limited



Dated : 15/06/2009

BAW56WS

PACKAGE OUTLINE

Plastic surface mounted package; 2 leads

SOD-323

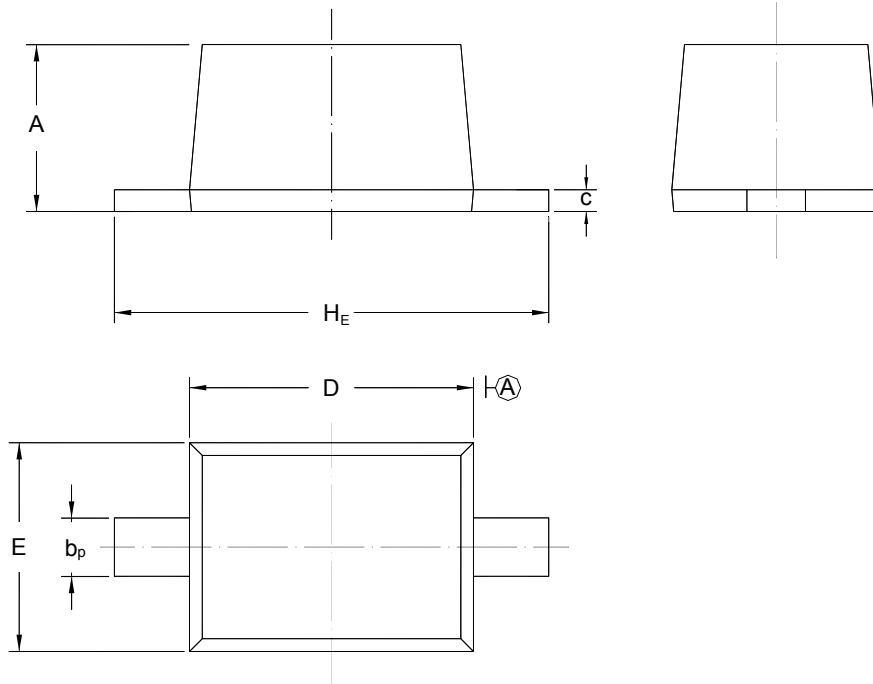

UNIT	A	b _p	C	D	E	H _E
mm	1.10 0.80	0.40 0.25	0.15 0.10	1.80 1.60	1.35 1.15	2.80 2.30

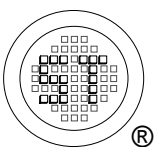

SEMTECH ELECTRONICS LTD.
Subsidiary of Sino-Tech International (BVI) Limited



Dated : 15/06/2009