

RB501V-40

SILICON EPITAXIAL PLANAR SCHOTTKY BARRIER DIODE

Features

- Small surface mounting type
- High reliability

Applications

- Low current rectification

PINNING

PIN	DESCRIPTION
1	Cathode
2	Anode

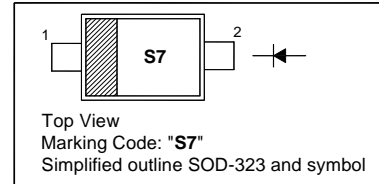

Absolute Maximum Ratings ($T_a = 25\text{ }^\circ\text{C}$)

Parameter	Symbol	Value	Unit
Peak Reverse Voltage	V_{RM}	45	V
Reverse Voltage	V_R	40	V
Mean Rectifying Current	I_O	0.1	A
Peak Forward Surge Current (60 Hz for 1 Cyc.)	I_{FSM}	1	A
Junction Temperature	T_j	125	$^\circ\text{C}$
Storage Temperature Range	T_{stg}	- 40 to + 125	$^\circ\text{C}$

Characteristics at $T_a = 25\text{ }^\circ\text{C}$

Parameter	Symbol	Typ.	Max.	Unit
Forward Voltage at $I_F = 100\text{ mA}$ at $I_F = 10\text{ mA}$	V_F V_F	- -	0.55 0.34	V V
Reverse Current at $V_R = 10\text{ V}$	I_R	-	30	μA
Capacitance Between Terminals at $V_R = 10\text{ V}$, $f = 1\text{ MHz}$	C_T	6	-	pF

Note: ESD sensitive product handling required.

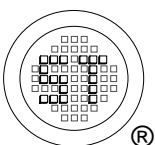

SEMTECH ELECTRONICS LTD.
Subsidiary of Sino-Tech International (BVI) Limited



Dated : 01/09/2006

RB501V-40

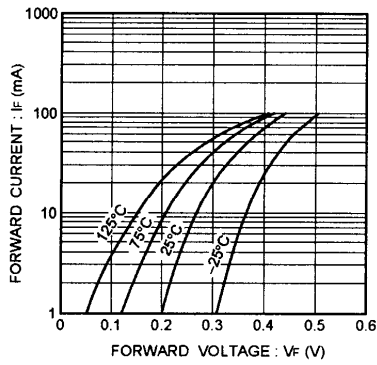

Fig. 1 Forward characteristics

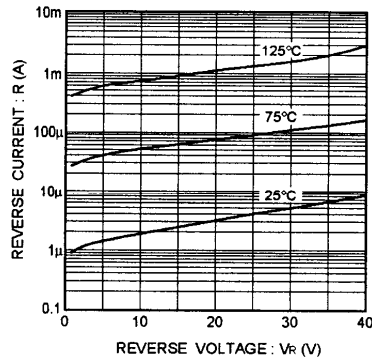

Fig. 2 Reverse characteristics

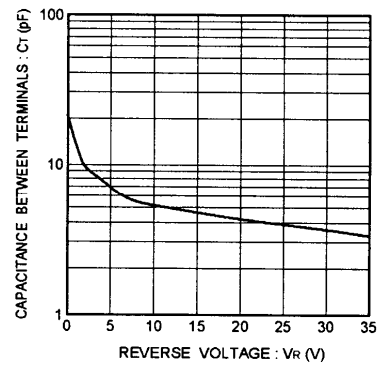

Fig. 3 Capacitance between terminals characteristics

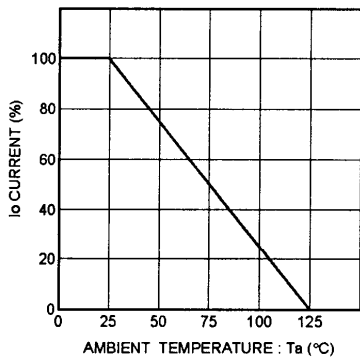
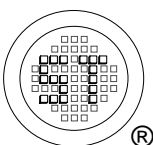

Fig. 4 Derating curve
(mounting on glass epoxy PCBs)



SEMTECH ELECTRONICS LTD.
Subsidiary of Sino-Tech International (BVI) Limited



Dated : 01/09/2006

RB501V-40

PACKAGE OUTLINE

Plastic surface mounted package; 2 leads

SOD-323

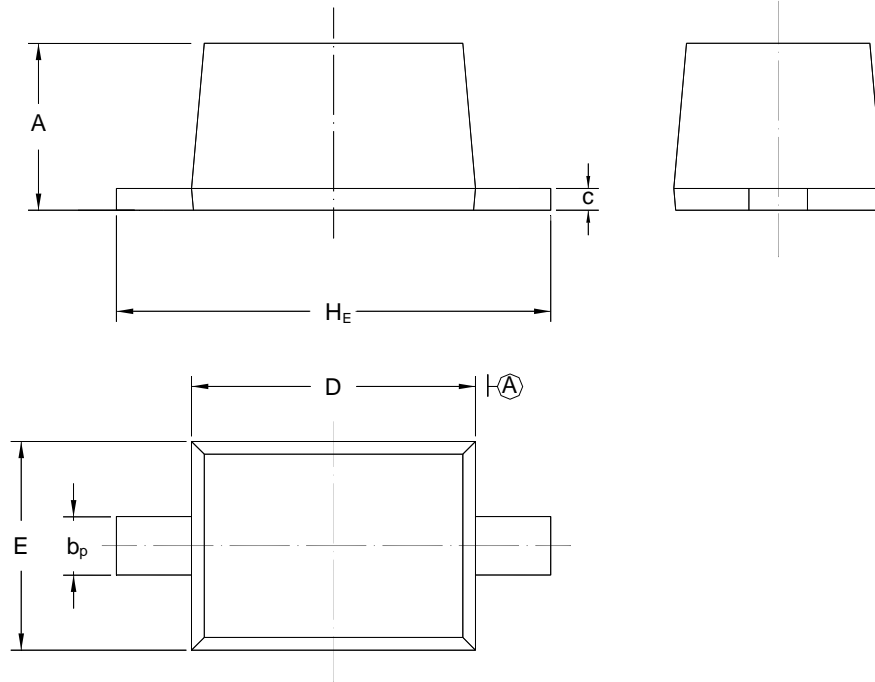

UNIT	A	b _p	C	D	E	H _E
mm	1.10 0.80	0.40 0.25	0.15 0.10	1.80 1.60	1.35 1.15	2.80 2.30

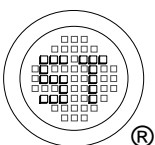

SEMTECH ELECTRONICS LTD.
Subsidiary of Sino-Tech International (BVI) Limited



Dated : 01/09/2006