

RB551V-30

SILICON EPITAXIAL PLANAR SCHOTTKY BARRIER DIODE

Features

- Small surface mounting type
- Ultra low V_F
- High reliability

Applications

- High frequency rectification switching regulation

PINNING

PIN	DESCRIPTION
1	Cathode
2	Anode

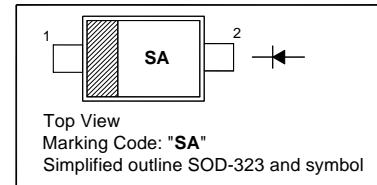

Absolute Maximum Ratings ($T_a = 25\text{ }^\circ\text{C}$)

Parameter	Symbol	Value	Unit
Peak Reverse Voltage	V_{RM}	30	V
DC Reverse Voltage	V_R	20	V
Mean Rectifying Current	I_O	0.5	A
Peak Forward Surge Current (60 Hz for 1 Cyc.)	I_{FSM}	2	A
Junction Temperature	T_j	125	$^\circ\text{C}$
Storage Temperature Range	T_{stg}	- 40 to + 125	$^\circ\text{C}$

Characteristics at $T_a = 25\text{ }^\circ\text{C}$

Parameter	Symbol	Max.	Unit
Forward Voltage at $I_F = 100\text{ mA}$ at $I_F = 500\text{ mA}$	V_F	0.36 0.47	V
Reverse Current at $V_R = 20\text{ V}$	I_R	100	μA

Note: ESD sensitive product handling required.

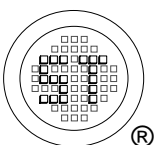

SEMTECH ELECTRONICS LTD.
Subsidiary of Sino-Tech International (BVI) Limited



Dated : 01/09/2006

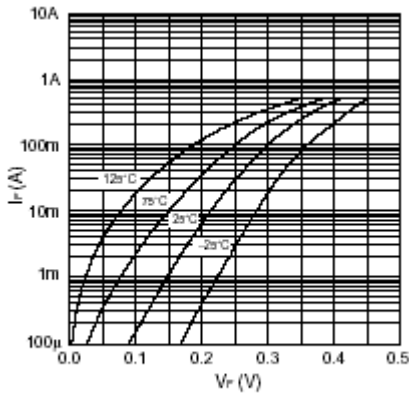

Fig.1 Forward characteristics

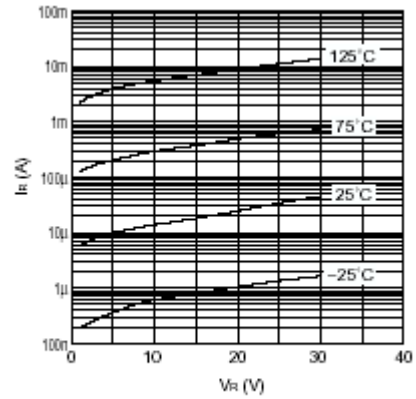

Fig.2 Reverse characteristics

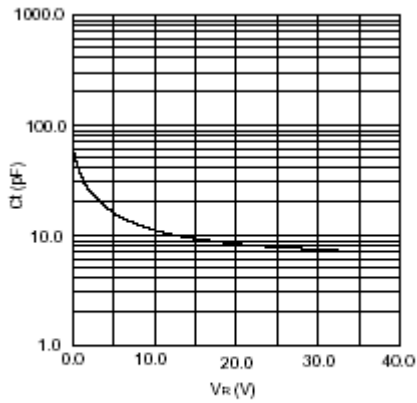

Fig.3 Capacitance between terminals characteristics

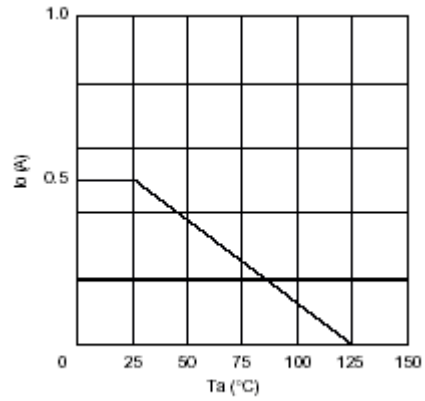
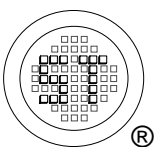

Fig.4 Derating curve



RB551V-30

PACKAGE OUTLINE

Plastic surface mounted package; 2 leads

SOD-323

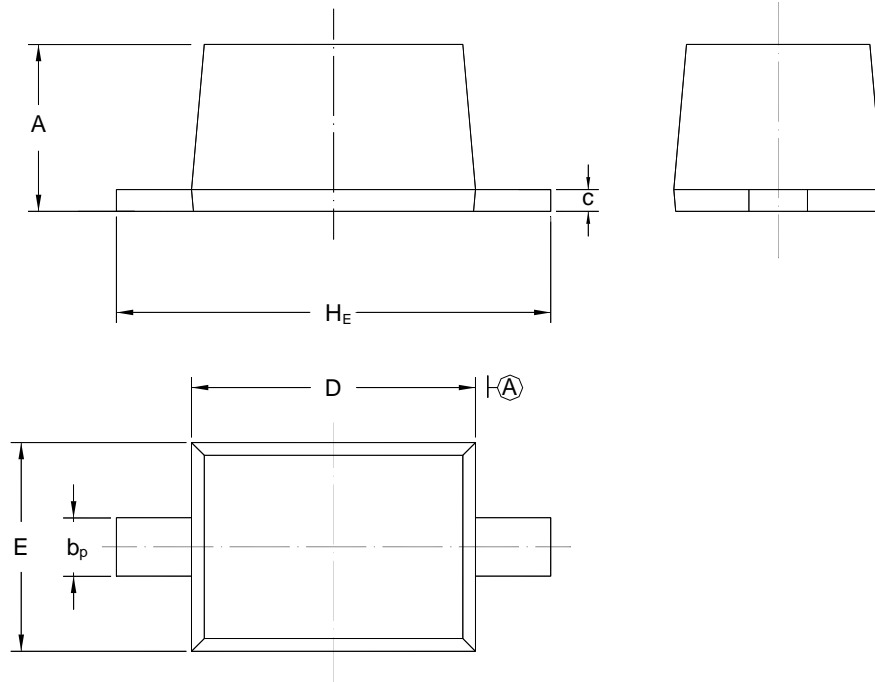

UNIT	A	b_p	C	D	E	H_E
mm	1.10 0.80	0.40 0.25	0.15 0.10	1.80 1.60	1.35 1.15	2.80 2.30

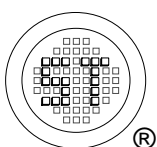

SEMTECH ELECTRONICS LTD.
Subsidiary of Sino-Tech International (BVI) Limited



Dated : 01/09/2006