

BY396 THRU BY399

3.0A FAST RECOVERY RECTIFIERS

DO-201AD

Features

- Low forward voltage
- High current capability
- High reliability
- High surge current capability

Mechanical Data

Cases: Molded plastic

Epoxy: UL 94V-0 rate flame retardant

Lead: Axial leads, solderable per MIL-STS-202,
Method 208 guaranteed.

Polarity: Color band denotes cathode end.

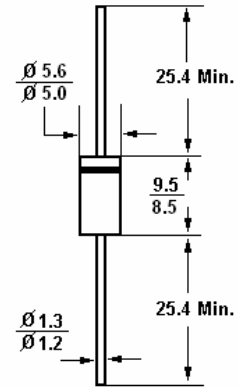

Dimensions in mm

Absolute Maximum Ratings ($T_a = 25^\circ\text{C}$)

		Symbol	Value	Unit
Recurrent Peak Reverse Voltage	BY396	V_{RRM}	100	V
	BY397	V_{RRM}	200	V
	BY398	V_{RRM}	400	V
	BY399	V_{RRM}	800	V
RMS Voltage	BY396	V_{RMS}	70	V
	BY397	V_{RMS}	140	V
	BY398	V_{RMS}	280	V
	BY399	V_{RMS}	560	V
DC Blocking Voltage	BY396	V_{DC}	100	V
	BY397	V_{DC}	200	V
	BY398	V_{DC}	400	V
	BY399	V_{DC}	800	V
Average Forward Rectified Current at $T_A=55^\circ\text{C}$		I_{FAV}	3	A
Peak Forward Surge Current, 8.3 ms Single Half Sine-wave Superimposed on Rated Load (JEDEC method)		I_{FSM}	150	A
Instantaneous Forward Voltage @ 3 A		V_F	1.2	V
DC Reverse Current @ $T_A=25^\circ\text{C}$ at Rated DC Blocking Voltage @ $T_A=100^\circ\text{C}$		I_R	10	μA
			150	μA
Reverse Recovery Time (Note 1)		t_{rr}	250	ns
Typical Junction Capacitance (Note 2)		C_j	60	pF
Operating Temperature Range		T_j	-65 to +150	$^\circ\text{C}$
Storage Temperature Range		T_s	-65 to +150	$^\circ\text{C}$
1) Reverse Recovery Test Conditions: $I_F=0.5\text{A}$, $I_R=1.0\text{A}$, $I_{RR}=0.25\text{A}$.				
2) Measured at 1MHz and Applied Reverse Voltage of 4.0V DC.				

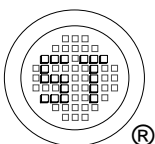

SEMTECH ELECTRONICS LTD.

(Subsidiary of Sino-Tech International Holdings Limited, a company listed on the Hong Kong Stock Exchange, Stock Code: 724)

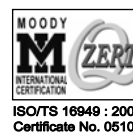

Dated : 14/07/2005 H

BY396 THRU BY399

FIG.1- MAXIMUM FORWARD CURRENT DERATING CURVE

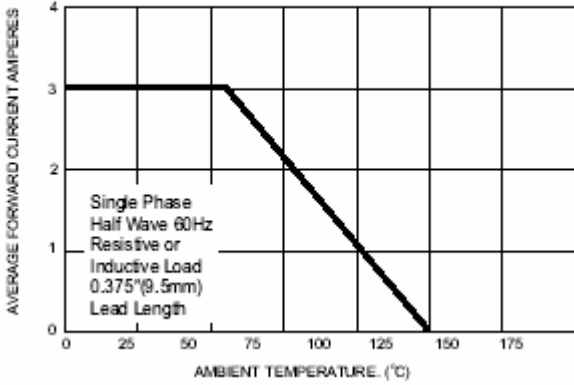

FIG.2- MAXIMUM NON-REPETITIVE PEAK FORWARD SURGE CURRENT

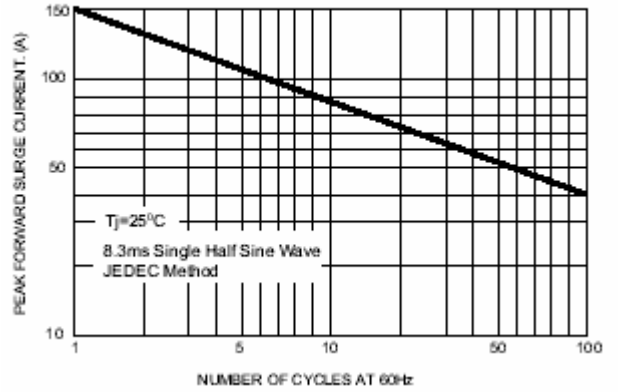

FIG.3- TYPICAL FORWARD CHARACTERISTICS

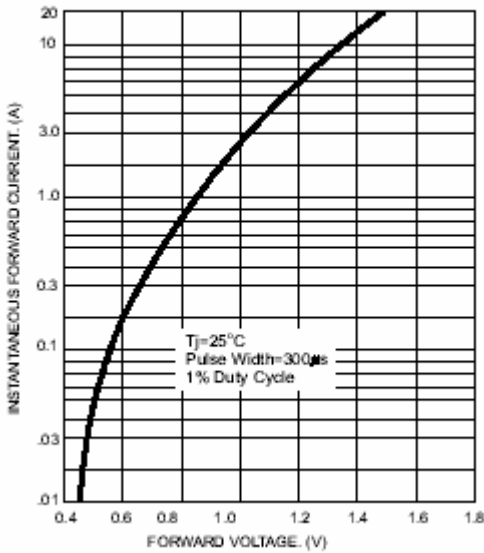

FIG.4- TYPICAL JUNCTION CAPACITANCE

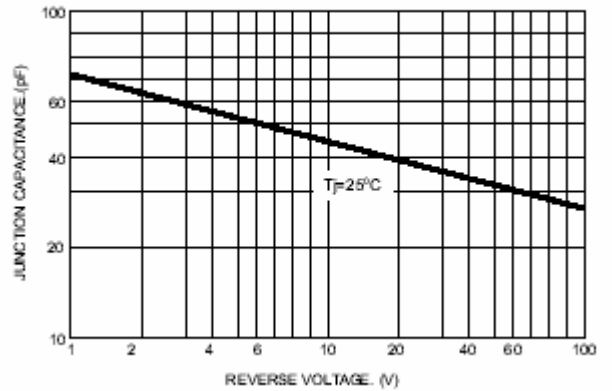
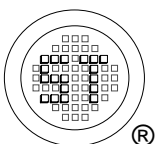
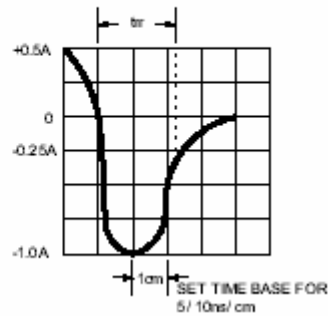
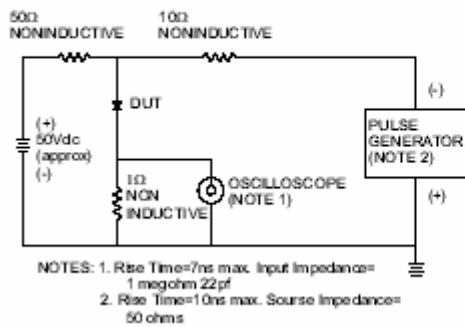

FIG.5- REVERSE RECOVERY TIME CHARACTERISTIC AND TEST CIRCUIT DIAGRAM



SEMTECH ELECTRONICS LTD.

(Subsidiary of Sino-Tech International Holdings Limited, a company listed on the Hong Kong Stock Exchange, Stock Code: 724)



ISO/TS 16949 : 2002
Certificate No. 05103



ISO 14001:2004
Certificate No. 7116



ISO 9001:2000
Certificate No. 0506098

Dated : 14/07/2005 H