

Transient Voltage Suppressors (TVS) Data Sheet

Features

- For surface mounted applications in order to optimize board space
- Low profile package
- Built-in strain relief
- Glass passivated junction
- Low inductance
- Excellent clamping capability
- 500W peak pulse power capability at 10/1000 μ s waveform, repetition rate (duty cycle): 0.01%
- Fast response time
- Typical I_R less than 1 μ A above 10V
- High Temperature soldering: 260 $^{\circ}$ C/10 seconds at terminals
- Plastic package has underwriters laboratory flammability 94V-0
- Meets MSL level 1, per J-STD-020
- Safety certification: UL: E244458



Mechanical Data

- Case: JEDEC DO-214AC. Molded plastic over glass passivated junction
- Terminal: Solder plated, solderable per MIL-STD-750, Method 2026
- Polarity: Color band denotes cathode except bi-directional models
- Standard Packaging: 12mm tape (EIA STD RS-481)
- Weight: 0.07g

Applications

- I/O interface
- AC/DC power supply
- Low frequency signal transmission line (RS232, RS485, etc.)

Maximum Ratings and Characteristics

Ratings at 25 $^{\circ}$ C ambient temperature unless otherwise specified.

| Rating | Symbol | Value | Units |
|---|-----------------|-------------|----------------|
| Peak pulse power dissipation at 10/1000 μ s waveform (Note1, Note2, Fig.1) | P_{PPM} | Minimum 500 | Watts |
| Peak pulse current of at 10/1000 μ s waveform (Note 1, Fig.3) | I_{PPM} | See Table | Amps |
| Steady state power dissipation at $T_A=50^{\circ}$ C (Fig.5) | $P_{M(AV)}$ | 3.3 | Watts |
| Peak forward surge current, 8.3ms single half sine-wave superimposed on rated load, (JEDEC Method) (Note3, Fig.6) | I_{FSM} | 100 | Amps |
| Operating junction and Storage Temperature Range. | T_J, T_{STG} | -65 to +150 | $^{\circ}$ C |
| Typical thermal resistance junction to lead | $R_{\theta JL}$ | 20 | $^{\circ}$ C/W |
| Typical thermal resistance junction to ambient | $R_{\theta JA}$ | 100 | $^{\circ}$ C/W |

Notes: 1. Non-repetitive current pulse, per Fig.3 and derated above $T_A=25^{\circ}$ C per Fig.2.

2. Mounted on 5.0mm \times 5.0mm (0.03mm thick) copper pads to each terminal.

3. 8.3ms single half sine-wave, or equivalent square wave, duty cycle=4 pulses per minutes maximum.

Dimensions (SMA/DO-214AC)

| | Symbol | Millimeters | | Inches | |
|--|--------|-------------|-------|--------|-------|
| | | Min. | Max. | Min. | Max. |
| | L | 3.99 | 4.50 | 0.157 | 0.177 |
| | D | 2.54 | 2.79 | 0.100 | 0.110 |
| | D1 | 1.25 | 1.65 | 0.049 | 0.065 |
| | T | 4.93 | 5.28 | 0.194 | 0.208 |
| | T1 | 0.76 | 1.52 | 0.030 | 0.060 |
| | d | - | 0.203 | - | 0.008 |
| | H | 2.00 | 2.50 | 0.079 | 0.098 |
| | H1 | 1.98 | 2.29 | 0.078 | 0.090 |

Electrical Characteristics (T_A=25°C)

| Part Number | | Type ① | Device Marking Code | | Reverse Stand-Off Voltage | Breakdown Voltage @I _T | Test Current | Maximum Clamping Voltage @I _{PP} | Peak Pulse Current | Reverse Leakage @V _{RWM} |
|----------------|---------------|-----------|---------------------|----|---------------------------|-----------------------------------|---------------------|---|---------------------|-----------------------------------|
| Unidirectional | Bidirectional | | UNI | BI | V _{RWM} (V) | V _{BR} (V) | I _T (mA) | V _C (V) | I _{PP} (A) | I _R (μA) |
| SMAJ5.0A | SMAJ5.0CA | HP | AE | WE | 5.0 | 6.40~7.00 | 10 | 9.2 | 55.5 | 800 |
| SMAJ6.0A | SMAJ6.0CA | HP | AG | WG | 6.0 | 6.67~7.37 | 10 | 10.3 | 49.6 | 800 |
| SMAJ6.5A | SMAJ6.5CA | HP | AK | WK | 6.5 | 7.22~7.98 | 10 | 11.2 | 45.6 | 500 |
| SMAJ7.0A | SMAJ7.0CA | HP | AM | WM | 7.0 | 7.78~8.60 | 10 | 12.0 | 42.5 | 200 |
| SMAJ7.5A | SMAJ7.5CA | HP | AP | WP | 7.5 | 8.33~9.21 | 1 | 12.9 | 39.6 | 100 |
| SMAJ8.0A | SMAJ8.0CA | HP | AR | WR | 8.0 | 8.89~9.83 | 1 | 13.6 | 37.6 | 50 |
| SMAJ8.5A | SMAJ8.5CA | HP | AT | WT | 8.5 | 9.44~10.40 | 1 | 14.4 | 35.4 | 20 |
| SMAJ9.0A | SMAJ9.0CA | HP | AV | WV | 9.0 | 10.00~11.10 | 1 | 15.4 | 33.2 | 10 |
| SMAJ10A | SMAJ10CA | HP | AX | WX | 10.0 | 11.10~12.30 | 1 | 17.0 | 30.0 | 5 |
| SMAJ11A | SMAJ11CA | HP | AZ | WZ | 11.0 | 12.20~13.50 | 1 | 18.2 | 28.1 | 1 |
| SMAJ12A | SMAJ12CA | HP | BE | XE | 12.0 | 13.30~14.70 | 1 | 19.9 | 25.7 | 1 |
| SMAJ13A | SMAJ13CA | HP | BG | XG | 13.0 | 14.40~15.90 | 1 | 21.5 | 23.8 | 1 |
| SMAJ14A | SMAJ14CA | HP | BK | XK | 14.0 | 15.60~17.20 | 1 | 23.2 | 22.0 | 1 |
| SMAJ15A | SMAJ15CA | HP | BM | XM | 15.0 | 16.70~18.50 | 1 | 24.4 | 24.5 | 1 |
| SMAJ16A | SMAJ16CA | HP | BP | XP | 16.0 | 17.80~19.70 | 1 | 26.0 | 19.6 | 1 |
| SMAJ17A | SMAJ17CA | HP | BR | XR | 17.0 | 18.90~20.90 | 1 | 27.6 | 18.5 | 1 |

Electrical Characteristics

| Part Number | | Type ① | Device Marking Code | | Reverse Stand-Off Voltage | Breakdown Voltage @ I_T | Test Current | Maximum Clamping Voltage @ I_{PP} | Peak Pulse Current | Reverse Leakage @ V_{RWM} |
|----------------|---------------|-----------|---------------------|----|---------------------------|---------------------------|--------------|-------------------------------------|--------------------|-----------------------------|
| Unidirectional | Bidirectional | | UNI | BI | $V_{RWM}(V)$ | $V_{BR}(V)$ | $I_T(mA)$ | $V_C(V)$ | $I_{PP}(A)$ | $I_R(\mu A)$ |
| SMAJ18A | SMAJ18CA | HP | BT | XT | 18.0 | 20.00~22.10 | 1 | 29.2 | 17.5 | 1 |
| SMAJ20A | SMAJ20CA | HP | BV | XV | 20.0 | 22.20~24.50 | 1 | 32.4 | 15.8 | 1 |
| SMAJ22A | SMAJ22CA | HP | BX | XX | 22.0 | 24.40~26.90 | 1 | 35.5 | 14.4 | 1 |
| SMAJ24A | SMAJ24CA | HP | BZ | XZ | 24.0 | 26.70~29.50 | 1 | 38.9 | 13.2 | 1 |
| SMAJ26A | SMAJ26CA | HP | CE | YE | 26.0 | 28.90~31.90 | 1 | 42.1 | 12.2 | 1 |
| SMAJ28A | SMAJ28CA | HP | CG | YG | 28.0 | 31.10~34.40 | 1 | 45.4 | 11.3 | 1 |
| SMAJ30A | SMAJ30CA | HP | CK | YK | 30.0 | 33.30~36.80 | 1 | 48.4 | 10.5 | 1 |
| SMAJ33A | SMAJ33CA | HP | CM | YM | 33.0 | 36.70~40.60 | 1 | 53.3 | 9.6 | 1 |
| SMAJ36A | SMAJ36CA | HP | CP | YP | 36.0 | 40.00~44.20 | 1 | 58.1 | 8.8 | 1 |
| SMAJ40A | SMAJ40CA | HP | CR | YR | 40.0 | 44.40~49.10 | 1 | 64.5 | 7.9 | 1 |
| SMAJ43A | SMAJ43CA | HP | CT | YT | 43.0 | 47.80~52.80 | 1 | 69.4 | 7.4 | 1 |
| SMAJ45A | SMAJ45CA | HP | CV | YV | 45.0 | 50.00~55.30 | 1 | 72.7 | 7.1 | 1 |
| SMAJ48A | SMAJ48CA | HP | CX | YX | 48.0 | 53.30~58.90 | 1 | 77.4 | 6.6 | 1 |
| SMAJ51A | SMAJ51CA | HP | CZ | YZ | 51.0 | 56.70~62.70 | 1 | 82.4 | 6.2 | 1 |
| SMAJ54A | SMAJ54CA | HP | RE | ZE | 54.0 | 60.00~66.30 | 1 | 87.1 | 5.9 | 1 |
| SMAJ58A | SMAJ58CA | HP | RG | ZG | 58.0 | 64.40~71.20 | 1 | 93.6 | 5.5 | 1 |
| SMAJ60A | SMAJ60CA | HP | RK | ZK | 60.0 | 66.70~73.70 | 1 | 96.8 | 5.3 | 1 |
| SMAJ64A | SMAJ64CA | HP | RM | ZM | 64.0 | 71.10~78.60 | 1 | 103.0 | 5.0 | 1 |
| SMAJ70A | SMAJ70CA | HP | RP | ZP | 70.0 | 77.80~86.00 | 1 | 113.0 | 4.5 | 1 |
| SMAJ75A | SMAJ75CA | HP | RR | ZR | 75.0 | 83.30~92.10 | 1 | 121.0 | 4.3 | 1 |
| SMAJ78A | SMAJ78CA | HP | RT | ZT | 78.0 | 86.70~95.80 | 1 | 126.0 | 4.1 | 1 |
| SMAJ85A | SMAJ85CA | HP | RV | ZV | 85.0 | 94.40~104.00 | 1 | 137.0 | 3.7 | 1 |
| SMAJ90A | SMAJ90CA | HP | RX | ZX | 90.0 | 100.00~111.00 | 1 | 146.0 | 3.5 | 1 |
| SMAJ100A | SMAJ100CA | HP | RZ | ZZ | 100.0 | 111.00~123.00 | 1 | 162.0 | 3.1 | 1 |
| SMAJ110A | SMAJ110CA | HP | SE | VE | 110.0 | 122.00~135.00 | 1 | 177.0 | 2.9 | 1 |
| SMAJ120A | SMAJ120CA | HP | SG | VG | 120.0 | 133.00~147.00 | 1 | 193.0 | 2.6 | 1 |
| SMAJ130A | SMAJ130CA | HP | SK | VK | 130.0 | 144.00~159.00 | 1 | 209.0 | 2.5 | 1 |
| SMAJ150A | SMAJ150CA | HP | SM | VM | 150.0 | 167.00~185.00 | 1 | 243.0 | 2.1 | 1 |

Notes: For bidirectional type having V_{RWM} of 10V and less, the I_R limit is double.

① Specific code by request.

Figure 1. Peak Pulse Power Rating Curve

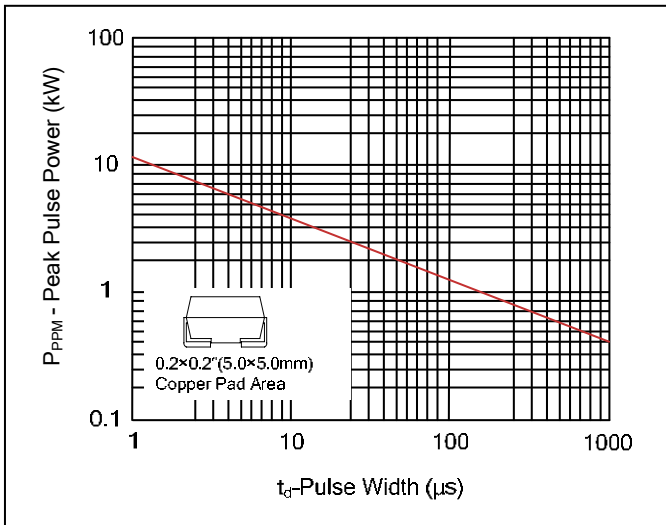

Figure 2. Pulse Derating Curve

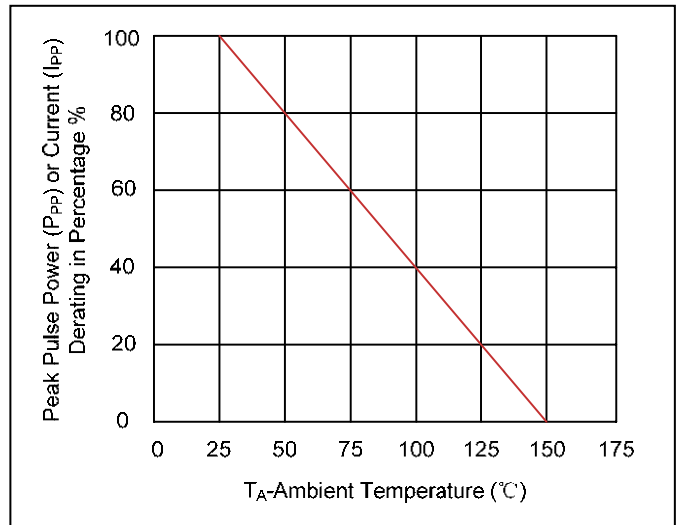

Figure 3. Pulse Waveform

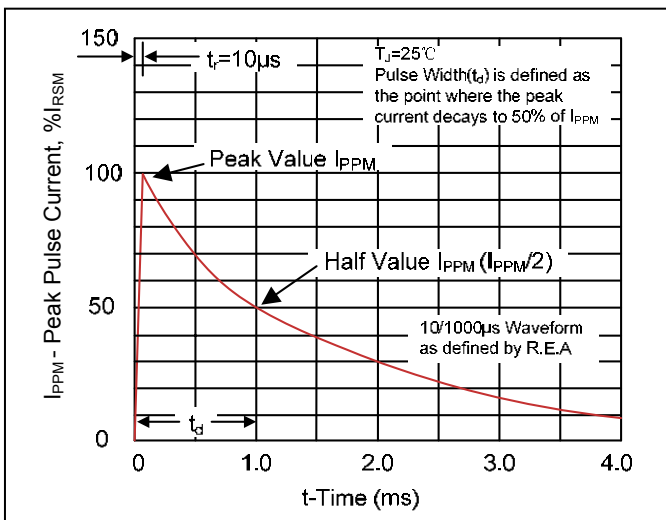

Figure 4. Typical Junction Capacitance

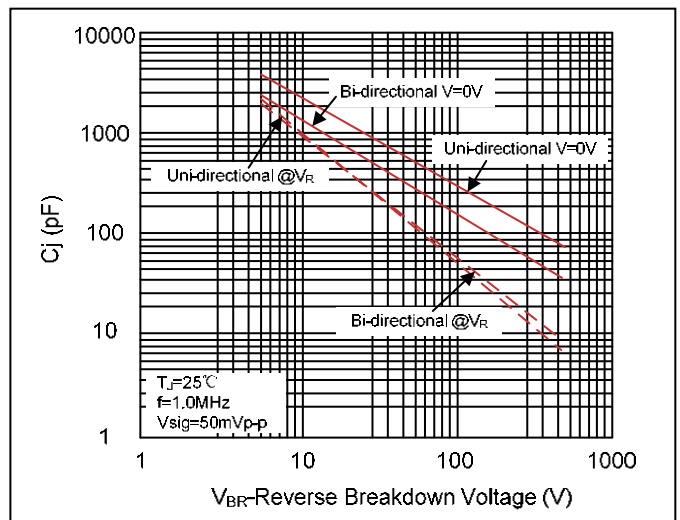

Figure 5. Steady State Power Dissipation Derating Curve

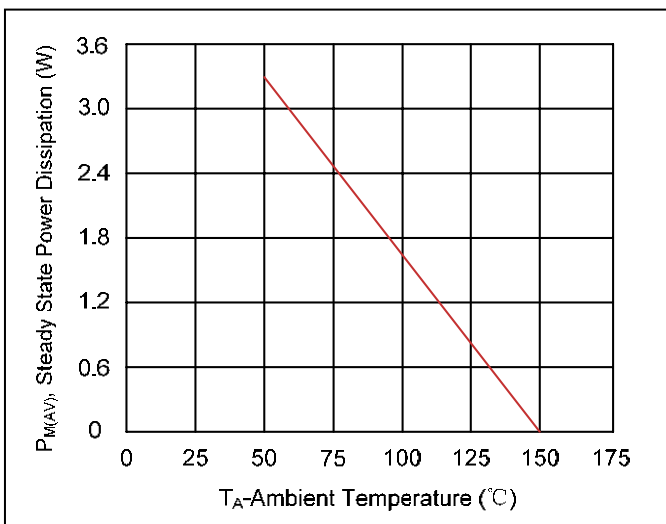
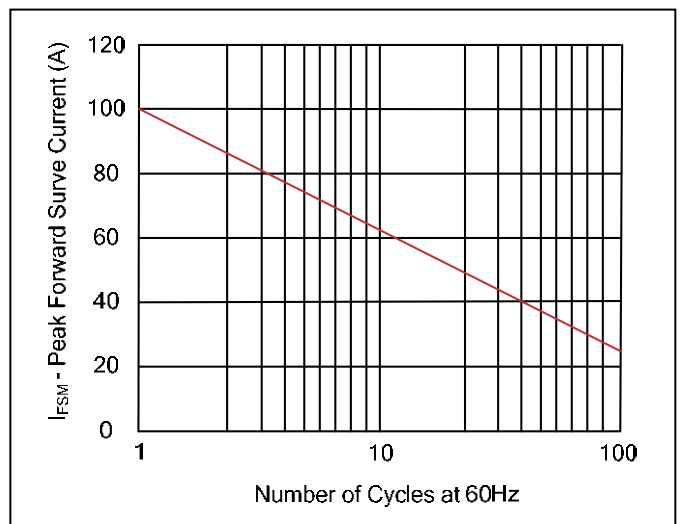
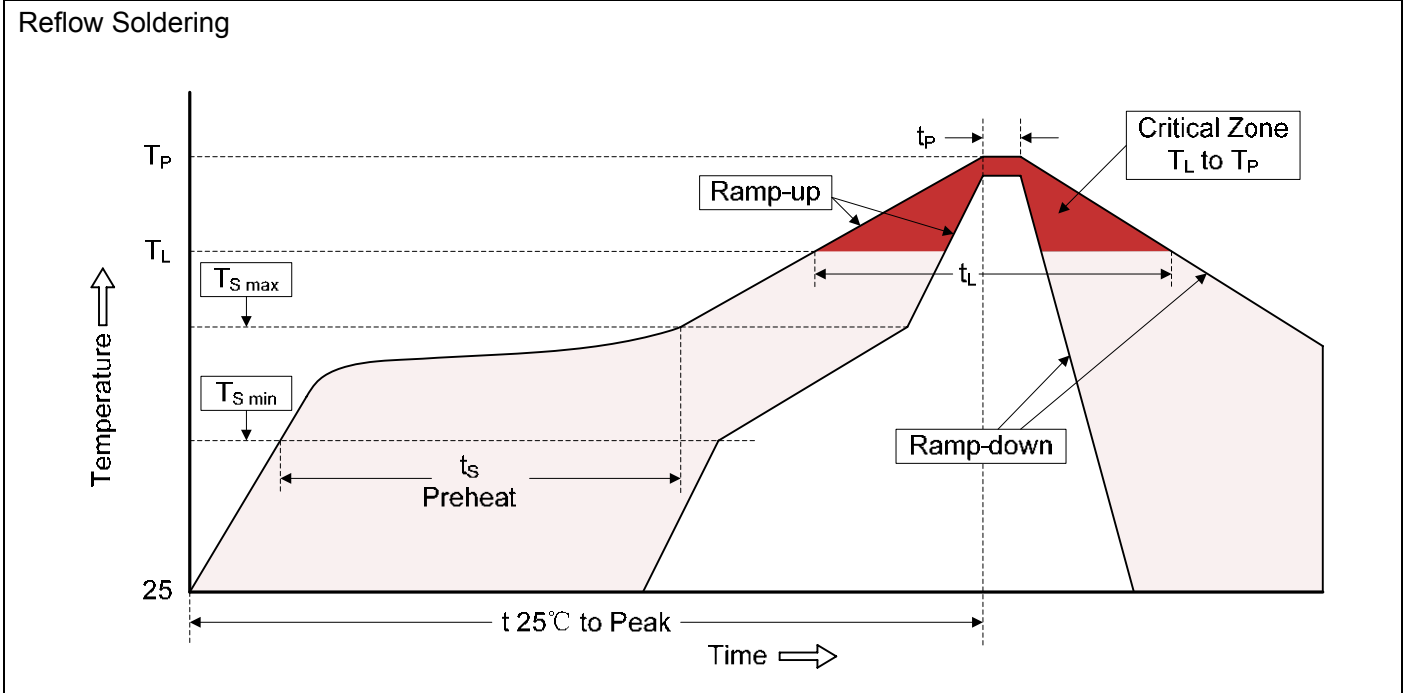

Figure 6. Maximum Non-Repetitive Forward Surge Current Uni-Directional Only



Recommended Soldering Conditions



Recommended Conditions

| Profile Feature | Pb-Free Assembly |
|---|----------------------------------|
| Average ramp-up rate (T_L to T_P) | 3°C/second max. |
| Preheat -Temperature Min ($T_{S\ min}$) -Temperature Max ($T_{S\ max}$) -Time (min to max) (t_s) | 150°C 200°C 60-180 seconds |
| $T_{S\ max}$ to T_L -Ramp-up Rate | 3°C/second max. |
| Time maintained above: -Temperature (T_L) -Time (t_L) | 217°C 60-150 seconds |
| Peak Temperature (T_P) | 260°C |
| Time within 5°C of actual Peak Temperature (t_p) | 20-40 seconds |
| Ramp-down Rate | 6°C/second max. |
| Time 25°C to Peak Temperature | 8 minutes max. |

Marking Code

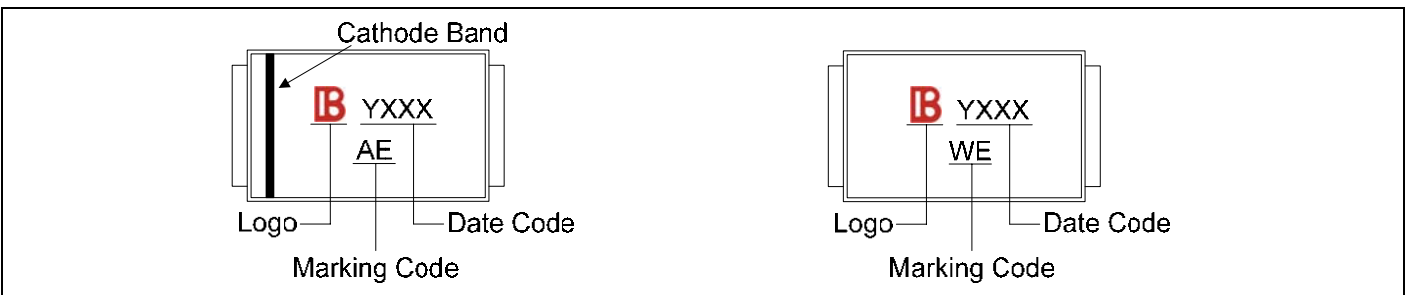

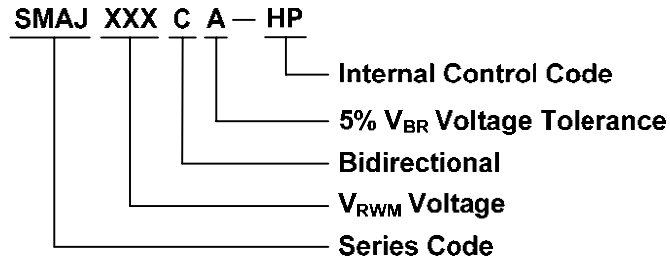

Packaging

| Tape | | Symbol | Dimension (mm) | | |
|-------------------|-----------|-------------------|----------------|----|------------|
| | | W | 12.00±0.20 | | |
| | | P0 | 4.00±0.10 | | |
| | | P1 | 4.00±0.10 | | |
| | | P2 | 2.00±0.10 | | |
| | | D0 | Φ1.5±0.10 | | |
| | | D1 | Φ1.5±0.10 | | |
| | | E | 1.75±0.10 | | |
| | | F | 5.50±0.05 | | |
| | | A0 | 2.79±0.10 | | |
| | | B0 | 5.33±0.10 | | |
| | | K0 | 2.55±0.15 | | |
| | | T | 0.25±0.05 | | |
| | | 7" Reel | | D2 | Φ178.0±2.0 |
| | | | | D3 | Φ50.0Min. |
| D4 | Φ13.0±0.5 | | | | |
| W1 | 16.0±2.0 | | | | |
| Quantity: 1000PCS | | | | | |
| 13" Reel | | | | D5 | Φ330.0±2.0 |
| | | D6 | Φ13.5±0.5 | | |
| | | H | 2.5±1.0 | | |
| | | W2 | 16.0±2.0 | | |
| | | Quantity: 5000PCS | | | |