

4.0 A Single-Phase Silicon Bridge Rectifier
Rectifier Reverse Voltage 50 to 1000V

Features

- Ideal for printed circuit board mounting
- This series is UL listed under the Recognized Component Index, file number E142814
- The plastic material used carries Underwriters Laboratory flammability recognition 94V-0
- Built-in printed circuit board stand-offs
- High case dielectric strength
- High temperature soldering guaranteed 265°C/10 seconds at 5 lbs (2.3kg) tension

Mechanical Data

Case: Reliable low cost construction utilizing molded plastic technique
 Terminals: Plated leads solderable per MIL-STD-202, Method 208
 Mounting Position: Any
 Weight: 0.2 ounce, 5.6 grams (approx)

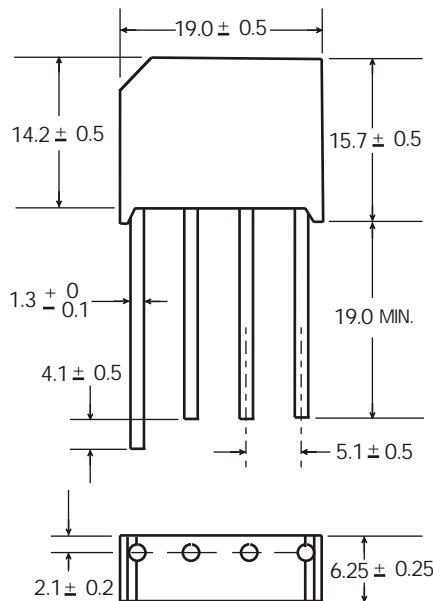

Dimensions in millimeters(1mm =0.0394")

Maximum Ratings & Thermal Characteristics

Rating at 25°C ambient temperature unless otherwise specified, Resistive or Inductive load, 60 Hz.
 For Capacitive load derate current by 20%.

Parameter	Symbol	KBL005	KBL01	KBL02	KBL04	KBL06	KBL08	KBL10	unit
Maximum repetitive peak reverse voltage	VRRM	50	100	200	400	600	800	1000	V
Maximum RMS bridge input voltage	VRMS	35	70	140	280	420	560	700	V
Maximum DC blocking voltage	VDC	50	100	200	400	600	800	1000	V
Maximum average forward rectified output current at TA=50°C	IF(AV)	4.0							A
Peak forward surge current single sine-wave superimposed on rated load (JEDEC Method)	IFSM	200							A
Rating for fusing (t<8.3ms)	I ² t	166							A ² sec
Typical thermal resistance per element (1)	ReJA	10.0							°C / W
Operating junction and storage temperature range	TJ, TSTG	-55 to + 150							°C

Electrical Characteristics

Rating at 25°C ambient temperature unless otherwise specified. Resistive or Inductive load, 60Hz.
 For Capacitive load derate by 20 %.

Parameter	Symbol	KBL005	KBL01	KBL02	KBL04	KBL06	KBL08	KBL10	Unit
Maximum instantaneous forward voltage drop per leg at 4.0A	VF	1.1							V
Maximum DC reverse current at rated TA =25°C DC blocking voltage per element TA =125°C	IR	10 1000							μA

Notes: (1)Thermal resistance from Junction to Ambient on P.C.board mounting.

Rating and Characteristic Curves ($T_A=25^{\circ}\text{C}$ Unless otherwise noted)

KBL005 thru KBL10

Fig. 1 Derating Curve for Output Rectified Current

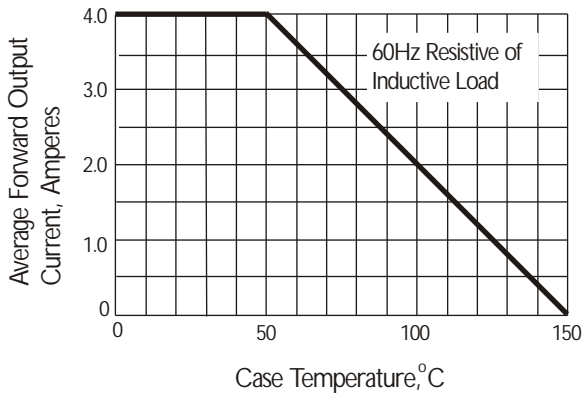

Fig. 2 Maximum Non-repetitive Peak Forward Surge Current

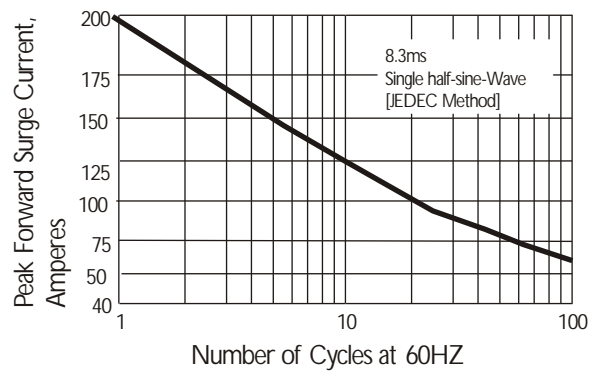

Fig. 3 Typical Instantaneous Forward Characteristics

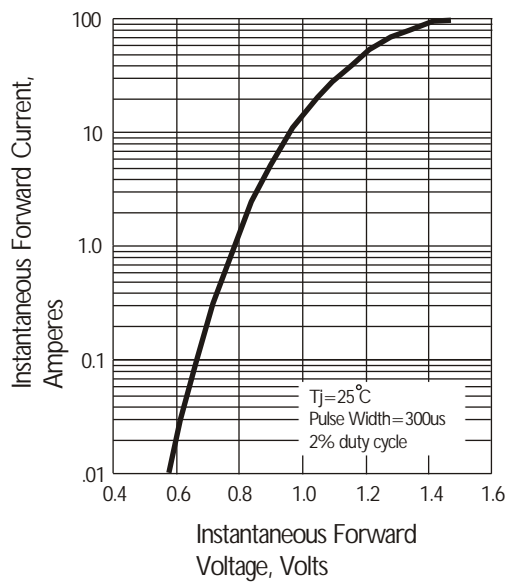

Fig. 4 Typical Reverse Characteristics at $T_J=25^{\circ}\text{C}$

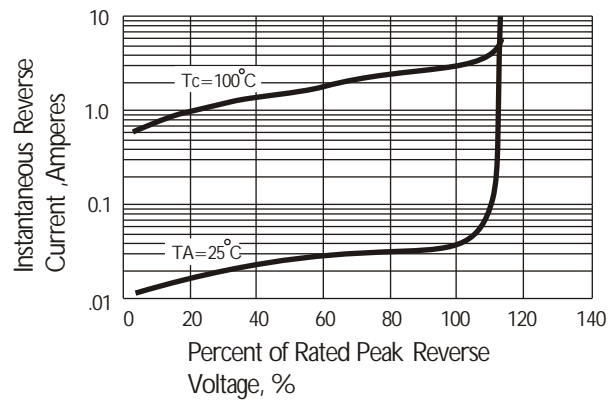

Fig. 5 Typical Junction Capacitance

