

SPECIFICATION FOR APPROVAL

REF : 20091116-C

PAGE: 1

PROD. NAME	SMD POWER INDUCTOR	ABC'S DWG NO.	SN3010□□□□□L□-□□□
		ABC'S ITEM NO.	

I . CONFIGURATION & DIMENSIONS :

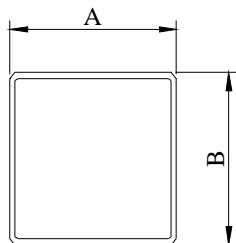

- A : 3.0 ± 0.10 m / m
- B : 3.0 ± 0.10 m / m
- C : 1.0 max. m / m
- D : 2.7 typ. m / m
- E : 0.9 ± 0.20 m / m
- F : 1.2 ± 0.20 m / m

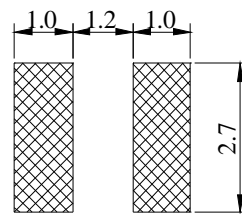
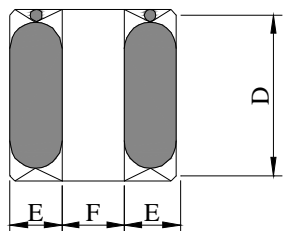
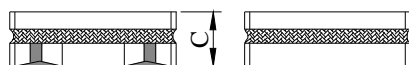

(PCB Pattern)

II . SCHEMATIC DIAGRAM :

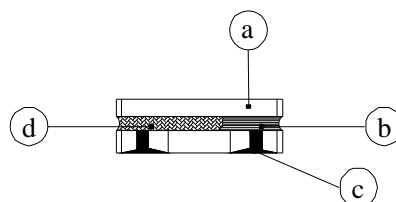

III . MATERIALS :

- a . Core : Ferrite core
- b . Wire : Enamelled Copper Wire (class H)
- c . Terminal : Ni/Cu/Ag alloy with Sn
- d . Coating : Magnetic Epoxy resin
- e . Remark : Products comply with RoHS'

requirements

IV . GENERAL SPECIFICATION :

- a . Storage Temp. : -40°C ----+85°C
- b . Operating Temp. : -40°C ----+125°C
- c . Resistance To Solder Heat : 260°C.10 Secs.

Peak Temp : 255°C max.
Max time above 217°C : 90sec max.

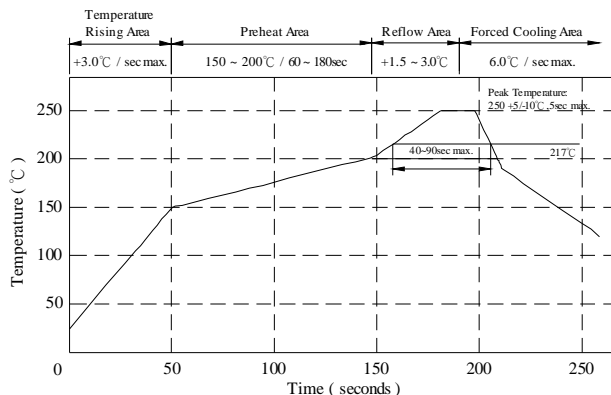

AR-001A

SPECIFICATION FOR APPROVAL

REF : 20091116-C

PAGE: 2

PROD. NAME	SMD POWER INDUCTOR	ABC'S DWG NO.	SN3010□□□□L□-□□□
		ABC'S ITEM NO.	

V . ELECTRICAL CHARACTERISTICS :

DWG No.	Inductance @0.1V/1MHz (μH)	RDC (Ω)		SRF (MHz) min.	Irms (A) typ.	Isat (A) typ.
		typ.	max.			
SN30101R0YL□-□□□	1.0 ± 30%	0.065	0.078	180	1.700	1.950
SN30101R5YL□-□□□	1.5 ± 30%	0.080	0.096	140	1.650	1.600
SN30102R2ML□-□□□	2.2 ± 20%	0.095	0.114	100	1.450	1.450
SN30103R3ML□-□□□	3.3 ± 20%	0.160	0.192	80	1.300	1.050
SN30104R7ML□-□□□	4.7 ± 20%	0.190	0.228	60	1.100	0.950
SN30106R8ML□-□□□	6.8 ± 20%	0.300	0.360	50	0.850	0.760
SN3010100ML□-□□□	10.0 ± 20%	0.450	0.540	45	0.720	0.610
SN3010150ML□-□□□	15.0 ± 20%	0.740	0.888	35	0.560	0.480
SN3010220ML□-□□□	22.0 ± 20%	0.980	1.176	25	0.500	0.420
SN3010330ML□-□□□	33.0 ± 20%	1.550	1.860	24	0.415	0.340
SN3010470ML□-□□□	47.0 ± 20%	2.000	2.400	19	0.320	0.270

1). □ : Packaging information ... Bulk Taping Reel

2). Irms base on Temp. rise 40°C typ.

3). Isat base on ΔL/L0A=30% typ.

SPECIFICATION FOR APPROVAL

REF: 20091116-C

PAGE: 3

PROD. NAME	SMD POWER INDUCTOR	ABC'S DWG NO.	SN3010□□□□L□-□□□
		ABC'S ITEM NO.	

VI . PACKAGING INFORMATION

(1) Configuration

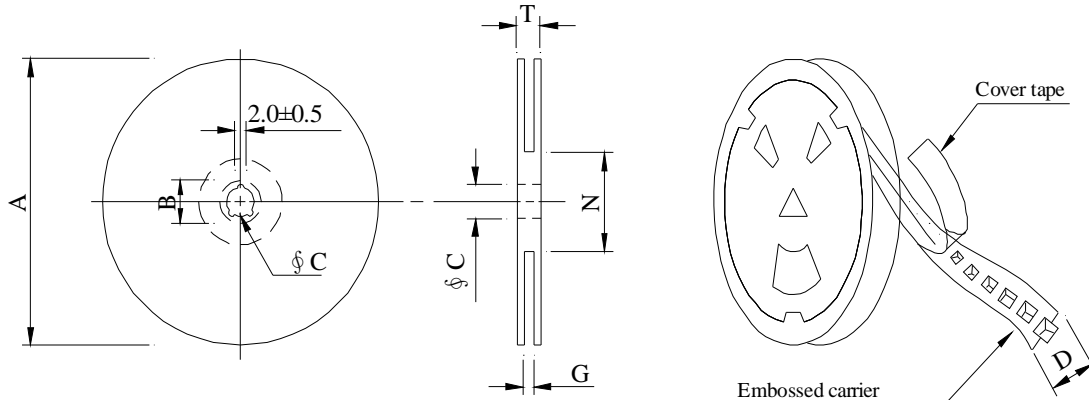

※Carrier tape width : D

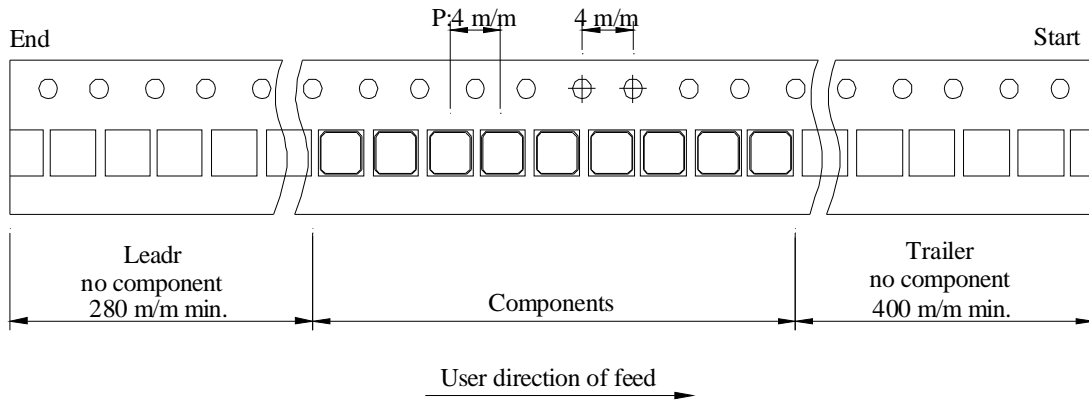

(2) Dimensions

Unit:m/m

Style	A	B	C	D	G	N	T
07 - 08	178	21±0.8	13	8	10 ⁺⁰	50 ⁻⁰	12.5

(3) Q'TY & G.W. Per package

Series	Inner : Reel			Outer : Carton		
	Q'TY (pcs)	G.W. (gw)	Style	Q'TY (pcs)	G.W. (Kg)	Size (cm)
SN3010	2000	500	07 - 08	80,000	17.5	42 x 41 x 24

AR-001A

SPECIFICATION FOR APPROVAL

REF : 20091116-C

PAGE: 4

PROD. NAME	SMD POWER INDUCTOR	ABC'S DWG NO.	SN3010□□□□L□-□□□
		ABC'S ITEM NO.	

VII . DWGING NUMBER EXPRESSION :

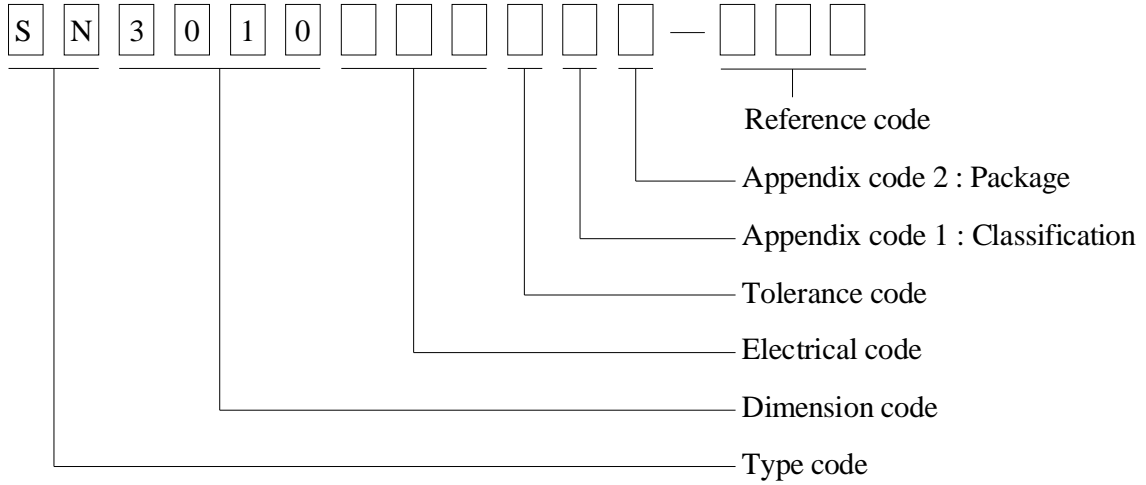

Appendix code 1 : Product Classification

- L : Lead Free Standard products comply with RoHS' requirements
- 1 ~ 9 : Lead Free Special products comply with RoHS' requirements

Appendix code 2 : Package Information

Code	Inner Package	Inner Package Q'TY	Remark
A	T.B.D.	T.B.D.	
B	T / R (Reel package)	2000 pcs	

SPECIFICATION FOR APPROVAL

REF : 20091116-C

PAGE: 5

PROD. NAME	SMD POWER INDUCTOR	ABC'S DWG NO.	SN3010□□□□L□-□□□
		ABC'S ITEM NO.	

VIII . RELIABILITY TEST :

Test item	Specification	Test condition						
Solderability	More than 90% of the terminal electrode shall be covered With fresh solder.	Preheat : 150±25°C for 60 seconds. Solder : Sn96.5 / Ag3 / Cu0.5 or equivalent Solder temp. : 235±5°C Flux : Rosin Dip time : 4±1 seconds						
Thermal shock test (Temp. cycle)	Electrical oharacteristics shall not change more than ±20%	<table style="width: 100%; border: none;"> <tr> <td style="text-align: center; border: none;">Room temp. 15 minutes</td> <td style="text-align: center; border: none;">→</td> <td style="text-align: center; border: none;">-40 °C 30 minutes</td> </tr> <tr> <td style="text-align: center; border: none;">Room temp. 15 minutes</td> <td style="text-align: center; border: none;">→</td> <td style="text-align: center; border: none;">+125 °C 30 minutes</td> </tr> </table> <p>Total : 50 cycles</p>	Room temp. 15 minutes	→	-40 °C 30 minutes	Room temp. 15 minutes	→	+125 °C 30 minutes
Room temp. 15 minutes	→	-40 °C 30 minutes						
Room temp. 15 minutes	→	+125 °C 30 minutes						
Humidity test		Temperature : 40±2°C Humidity : 90~95% Applied current : Per spec. Time : 500 hours						
High temp. Resistance test		Temperature : 125±2°C Applied current : Per spec. Time : 500 hours						

SPECIFICATION FOR APPROVAL

REF : 20091116-C

PAGE: 6

PROD. NAME	SMD POWER INDUCTOR	ABC'S DWG NO.	SN3010□□□□L□-□□□
		ABC'S ITEM NO.	

IX . UL CARD :

OBMW2

October 06, 2005

Magnet Wire-Component

ELEKTRISOLA (MALAYSLA) SDN BHD

E143312

JALAN DAMAI SATU JANDA BAIK 28750 BENTONG, PAHANG
DARUL MAKMUR MALAYSIA

Mtl Dsg	Mark Dsg	Coating Type	BC	OC	ANSI Typ	Temp Class
Estersol 180	E180	Polyesterimide (solderable)	—	—	MW-77	180
Amldester 200	A200	Polyesterimide	—	—	MW-74	200
Polysol-N 155	PN155	Polyurethane	—	Nylon	MW-80, MW-28	155, 130
Polysol 155	P155, G155	Polyurethane	—	—	MW-79, MW-75	155, 130
Polysol 155g	Pg155	Polyurethane	—	—	MW-75	130
Polysol 155p	Pp155, Gp155	Polyurethane	—	—	MW-79	155
Polysol 160	P160	Polyurethane	—	—	MW-79	155
Polysol 180	P180, G180	Polyurethane	—	—	MW-82, MW-79	180, 155
Polysol 170	P170 or G170	Polyurethane	—	—	MW-79	155
Polysol-N 180	PN180	Polyurethane	—	Nylon	MW-83	180
Polysol P155p	P155p	Polyurethane	—	—	MW-79	155

Marking : Company name, material designation or marked designation and factory identification on package ok reel

See General Information preceding These Recognitions

For use only in equipment where the acceptability of the combination is determined by Underwriters Laboratories Inc.