

SPECIFICATION FOR APPROVAL

REF :

PAGE: 1

PROD. NAME	SMD POWER INDUCTOR	ABC'S DWG NO. ABC'S ITEM NO.	SQ4532□□□□3□
---------------	--------------------	---------------------------------	--------------

I . MECHANICAL DIMENSIONS :

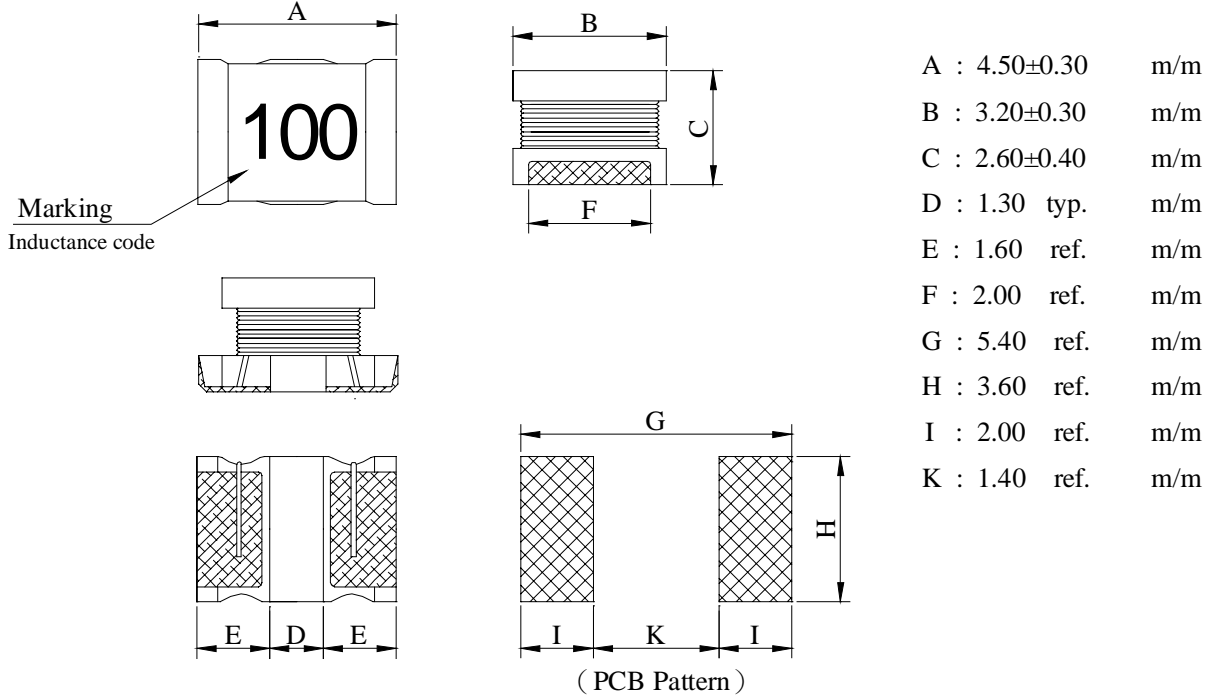

II . SCHEMATIC DIAGRAM :

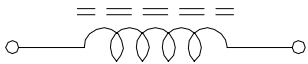

III . MATERIALS LIST :

- a . Core : Ferrite core
- b . Wire : Enamelled copper wire (class F)
- c . Terminal : Ag/Ni/Sn
- d . Remark : Lead content 200 ppm max.
include ferrite

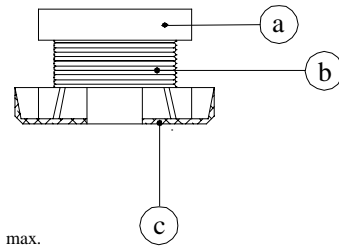

Peak Temp : 260°C max.
Max time above 230°C : 50sec max.
Max time above 200°C : 70sec max.

IV . GENERAL SPECIFICATION :

- a . Temp. rise : 20°C max
- b . Storage temp. : -40°C ----+125°C
- c . Operating temp. : -25°C ----+105°C
- d . Rated current (Irms) :
Current cause inductance drop within 10%
- e . Resistance to solder heat : 260°C .10 secs.

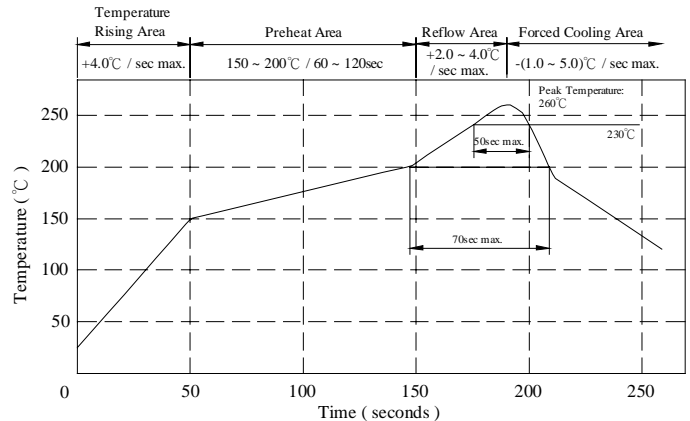

AE-001A

SPECIFICATION FOR APPROVAL

REF :

PAGE: 2

PROD. NAME	SMD POWER INDUCTOR	ABC'S DWG NO.	SQ4532□□□□3□
		ABC'S ITEM NO.	

V . ELECTRICAL CHARACTERISTICS :

DWG No.	Inductance (μ H)	Test Freq (Hz) L	SRF (MHz) min.	RDC (Ω) max.	IDC (mA) max.
SQ45321R0M3□	1.00±20%	1M	100.0	0.08	1080
SQ45321R5M3□	1.50±20%	1M	85.0	0.09	1000
SQ45322R2M3□	2.20±20%	1M	60.0	0.11	900
SQ45323R3M3□	3.30±20%	1M	47.0	0.13	800
SQ45324R7M3□	4.70±20%	1M	35.0	0.15	750
SQ45326R8M3□	6.80±20%	1M	30.0	0.20	720
SQ4532100K3□	10.00±10%	1M	23.0	0.24	650
SQ4532150K3□	15.00±10%	1M	20.0	0.32	570
SQ4532220K3□	22.00±10%	1M	15.0	0.60	420
SQ4532330K3□	33.00±10%	1M	12.0	1.00	310
SQ4532470K3□	47.00±10%	1M	10.0	1.10	280
SQ4532680K3□	68.00±10%	1M	8.4	1.70	220
SQ4532101K3□	100.00±10%	1M	6.8	2.20	190
SQ4532151K3□	150.00±10%	1M	5.5	3.50	130
SQ4532221K3□	220.00±10%	1M	4.5	4.00	110
SQ4532331K3□	330.00±10%	1M	3.6	6.80	100
SQ4532471K3□	470.00±10%	1M	3.0	8.50	90

1) □ : Packaging Information... A : Bulk B : Taping Reel

SPECIFICATION FOR APPROVAL

REF :

PAGE: 3

PROD. NAME	SMD POWER INDUCTOR	ABC'S DWG NO.	SQ4532□□□□3□
		ABC'S ITEM NO.	

VI . PACKAGING INFORMATION :

(1) Configuration

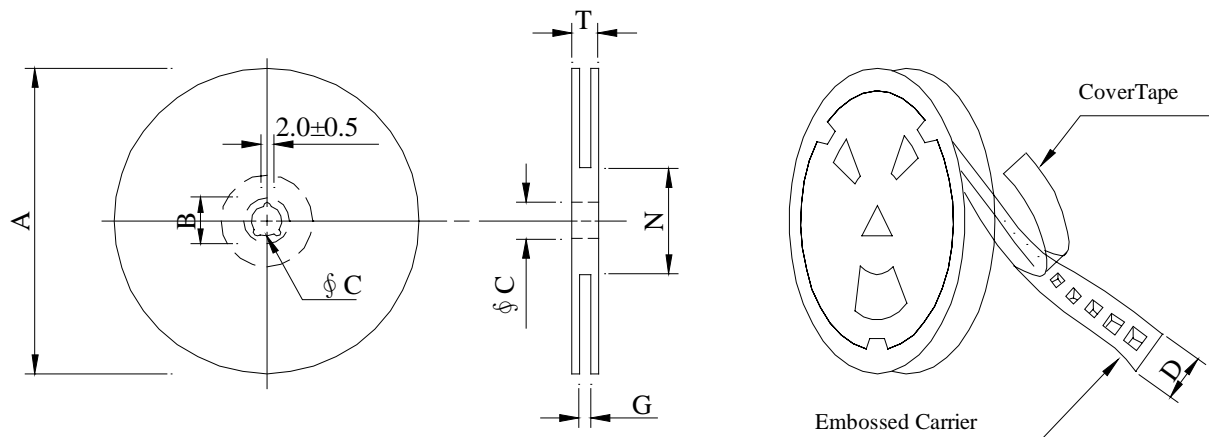

※Carrier Tape Width : D

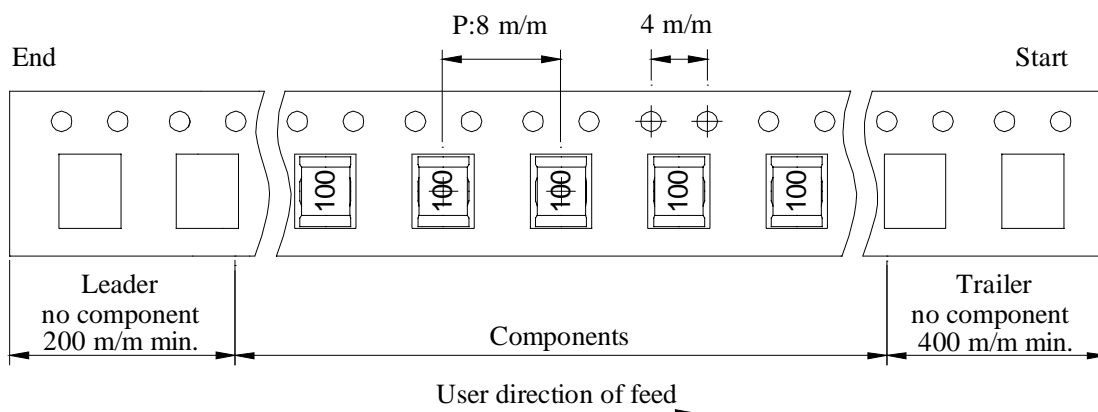

(2) Dimensions

Unit:m/m

STYLE	A	B	C	D	G	N	T
07 - 12	178	21±0.8	13	12	14 ⁺⁰	50 ⁻⁰	16.5
13 - 12	330	21±0.8	13±0.5	12	14 ⁺⁰	50 ⁻⁰	18.4

(3) Q'TY & G.W. Per package

Series	Inner : Reel			Outer : Carton		
	Q'TY (pcs)	G.W. (gw)	Style	Q'TY (pcs)	G.W. (Kg)	SIZE (cm)
SQ4532	500	130	07 - 12	20,000	7.20	42 x 41 x 24
SQ4532	2000	540	13 - 04	16,000	6.50	40 x 40 x 24

AE-001A

SPECIFICATION FOR APPROVAL

REF :

PAGE: 4

PROD. NAME	SMD POWER INDUCTOR	ABC'S DWG NO.	SQ4532□□□□3□
		ABC'S ITEM NO.	

VII . DWG EXPRESSION :

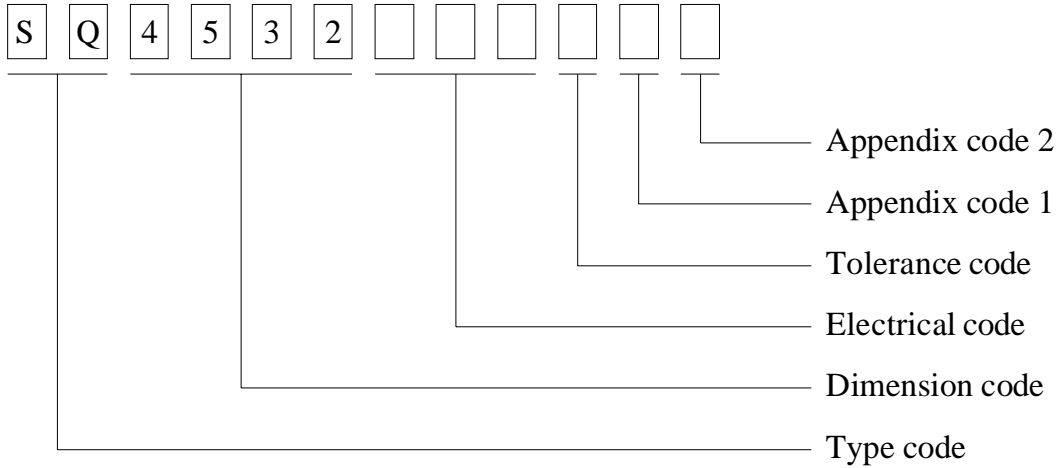

Appendix code 1 : S : Standard products
 A ~ K , M ~ R , T ~ Z : Special products
 L : Standard Lead Free products
 1 ~ 9 : Special Lead Free products

Appendix code 2 :

Code	Inner package	Inner package Q'TY	Remark
A	Empty	Empty	
B	T / R (Reel package)	500 pcs	
C	T / R (Reel package)	2000 pcs	

SPECIFICATION FOR APPROVAL

REF :

PAGE: 5

PROD. NAME	SMD POWER INDUCTOR	ABC'S DWG NO.	SQ4532□□□□3□
		ABC'S ITEM NO.	

VIII . RELIABILITY TEST :

Test item	Specification	Test condition						
Solderability	More than 90% of the terminal electrode shall be covered With fresh solder.	Preheat : 150±25°C for 60 seconds Solder : Sn96.5 / Ag3 / Cu0.5 or equivalent Solder temp. : 235±5°C Flux : Rosin Dip time : 4±1 seconds						
Thermal shock test (Temp. cycle)	Inductance shall not change more than ±10%	<table style="width: 100%; border: none;"> <tr> <td style="text-align: center; border: none;">Room temp. 15 minutes</td> <td style="text-align: center; border: none;">→</td> <td style="text-align: center; border: none;">-25±2 °C 30 minutes</td> </tr> <tr> <td style="text-align: center; border: none;">Room temp. 15 minutes</td> <td style="text-align: center; border: none;">→</td> <td style="text-align: center; border: none;">85±2 °C 30 minutes</td> </tr> </table> <p>Total : 50 cycles</p>	Room temp. 15 minutes	→	-25±2 °C 30 minutes	Room temp. 15 minutes	→	85±2 °C 30 minutes
Room temp. 15 minutes	→	-25±2 °C 30 minutes						
Room temp. 15 minutes	→	85±2 °C 30 minutes						
Humidity Resistance test		Temperature : 40±2°C Humidity : 90 ~ 95% Applied current : Per spec. Time : 500 hours						
High temp. Resistance test		Temperature : 105±2°C Applied current : Per spec. Time : 500 hours						

SPECIFICATION FOR APPROVAL

REF :

PAGE: 6

PROD. NAME	SMD POWER INDUCTOR	ABC'S DWG NO. ABC'S ITEM NO.	SQ4532□□□□3□
---------------	---------------------------	---------------------------------	--------------

IX . UL CARD :

OBMW2 September 8, 2000
Magnet Wire-Component
JUNG SHING WIRE CO LTD E174837
231 CHUNG CHENG RD, SEC 3 JEN-TEH HSIANG, TAINAN
HSIEN TAIWAN

Mtl Dsg	Mark Dsg	BC	Coat Typ	OC	ANSI Type	Temp Class
AIW	---	Polyamideimide		---	MW81-C	220
CFUEWB	---	Polyurethane		---	MW75C	130
EIAIW	---	Polyesterimide		Polyamideimide	MW35C	200
EILOCKY	---	Polyesterimide		Polyamide	---	180
EILOCKW	---	Polyesterimide		Modified Epoxy	---	200
EIW	---	Polyesterimide		---	---	220
EIW-2	---	Polyesterimide		---	MW74-C	200
FL.EILOCKY	---	Modified Polyester		Polyamide	---	155
LSFFW	---	Polyurethane		---	MW79-C	155
LSUEW	---	Polyurethane		---	---	130
PEW	---	Polyester		---	---	155
PEY	---	Polyester		Nylon	MW24-C	155
SF.FLW	---	Modified Polyester		---	MW26C	155
SF.EIW	---	Polyesterimide		---	MW77C	180
SF.BY@	---	Modified Polyester		Nylon	MW27-C	155
SF.FLY@	---	Modified Polyester		Nylon	MW27-C	155
SF.BLOCKBS	---	Modified Polyester		Modified Polyamide	---	155
SF.EILOCKY#	---	Polyesterimide		Polyamide	---	180
SF.EILOCKBS	---	Polyesterimide		Modified Polyamide	---	180
SF.BW@	---	Modified Polyester		---	MW26C	155
SFFW	---	Polyurethane		---	MW79	155

287806002 Page 1 of 2

A not-for-profit organization
dedicated to public safety and
committed to quality service

Mtl Dsg	Mark Dsg	BC	Coat Typ	OC	ANSI Type	Temp Class
SFFY	---	Polyurethane		Polyamide	MW80C	155
UEW-1	---	Polyurethane		---	MW2-C	105
UEW-2	---	Polyurethane		---	---	130
UEW-4	---	Polyurethane		---	MW75C	130
UEY	---	Polyurethane		Nylon	MW28-C	130
UEY-2	---	Polyurethane		Polyamide	MW28-C	130

@ - May be suffixed by LZ; # - May be suffixed by LZ, EL or LZI.
LZ - Signifies magnd wires twisted together; EL - signifies base coated magnet wire laid parallel with top coat applied overall; LZL - signi-
fies base coated magnet wire twisted together and covered with top coat overall.

Marking: Company name or trademarks **(JSW)** or 榮星電線 , material designation or marked designation on packaed or reel, and
Recognized Component Mark.

See General Information Preceding These Recognitions
For use only in equipment where the acceptability of the combination is determined by Underwriters Laboratories Inc.

287806002 Page 2 of 2

OBMW2E174837
September 8, 2000