

# SPECIFICATION FOR APPROVAL

REF :

PAGE: 1

PROD. NAME	WOUND CHIP INDUCTOR	ABC'S DWG NO.	SW2520□□□□2□
		ABC'S ITEM NO.	

**. CONFIGURATION & DIMENSIONS :**

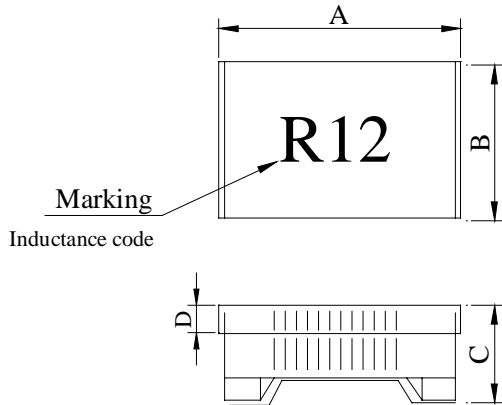

- A : 2.50±0.2      m/m
- B : 2.00±0.2      m/m
- C : 1.60±0.2      m/m
- D : 0.50            m/m
- E : 0.50            m/m
- F : 1.50            m/m
- G : 1.20            m/m
- H : 2.30            m/m
- I : 0.65            m/m

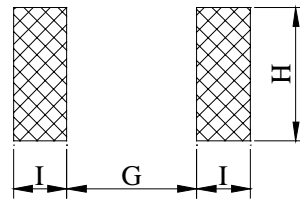
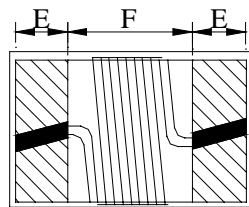

( PCB Pattern )

**. SCHEMATIC DIAGRAM :**

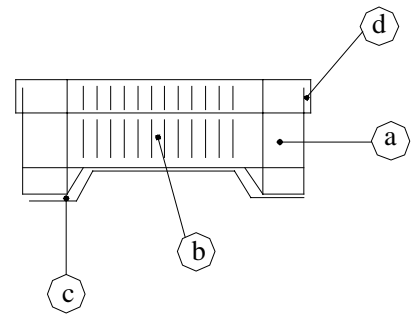

**. MATERIALS :**

- a . Core : Ferrite
- b . WIRE : Enamelled copper wire (class H)
- c . Terminal : Ag + Ni + Sn (lead content 100ppm max.)
- d . Encapsulate : Epoxy
- e . Remark : Lead content 1000ppm max.

include ferrite

- Peak Temp : 260    max.
- Max time above 230    : 50sec max.
- Max time above 200    : 70sec max.

**. GENERAL SPECIFICATION :**

- a . Temp rise : 15    max.
- b . Rated current : Current cause inductance drop within 10% max.
- c . Storage temp. : -40    ----+85
- d . Operating temp. : -40    ----+85

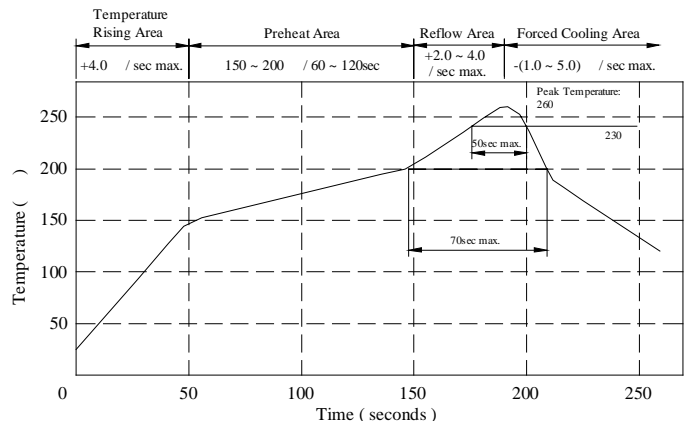

# SPECIFICATION FOR APPROVAL

REF :

PAGE: 2

PROD. NAME	WOUND CHIP INDUCTOR	ABC'S DWG NO.	SW2520□□□□2□
		ABC'S ITEM NO.	

. ELECTRICAL CHARACTERISTICS :

DWG No.	Inductance (uH)	Q min	Test Freq. (MHz)	SRF (MHz) min	RDC (Ω) max	IDC (mA) max
SW25201R2K2□	1.20±10%	20	7.96	280	1.30	230
SW25201R5K2□	1.50±10%	20	7.96	250	1.65	220
SW25201R8K2□	1.80±10%	20	7.96	200	2.20	210
SW25202R2K2□	2.20±10%	20	7.96	160	2.35	200
SW25202R7K2□	2.70±10%	20	7.96	130	2.60	195
SW25203R3K2□	3.30±10%	20	7.96	80	2.85	185
SW25203R9K2□	3.90±10%	20	7.96	50	4.00	180
SW25204R7K2□	4.70±10%	20	7.96	45	4.30	175
SW25205R6K2□	5.60±10%	20	7.96	42	2.60	170
SW25206R8K2□	6.80±10%	20	7.96	39	2.80	165
SW25208R2K2□	8.20±10%	20	7.96	36	3.05	160
SW2520100K2□	10.00±10%	15	2.52	33	3.50	150
SW2520120K2□	12.00±10%	15	2.52	30	3.60	140
SW2520150K2□	15.00±10%	15	2.52	26	4.00	130
SW2520180K2□	18.00±10%	15	2.52	24	4.50	120
SW2520220K2□	22.00±10%	15	2.52	22	4.80	110
SW2520270K2□	27.00±10%	15	2.52	21	5.30	95
SW2520330K2□	33.00±10%	15	2.52	20	6.10	85
SW2520390K2□	39.00±10%	15	2.52	18	8.30	60
SW2520470K2□	47.00±10%	15	2.52	17	12.00	45

1). □ : Packaging Information...  Bulk  Taping Reel

# SPECIFICATION FOR APPROVAL

REF :

PAGE: 3

PROD. NAME	WOUND CHIP INDUCTOR	ABC'S DWG NO.	SW2520□□□□2□
		ABC'S ITEM NO.	

CURVE :

**L vs Freq Plot**

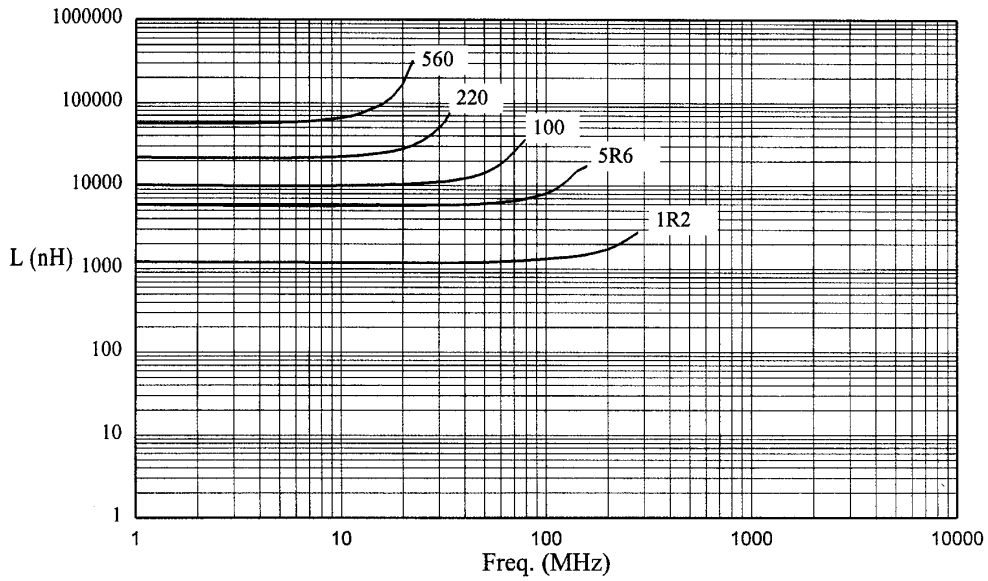

**Q vs Freq Plot**

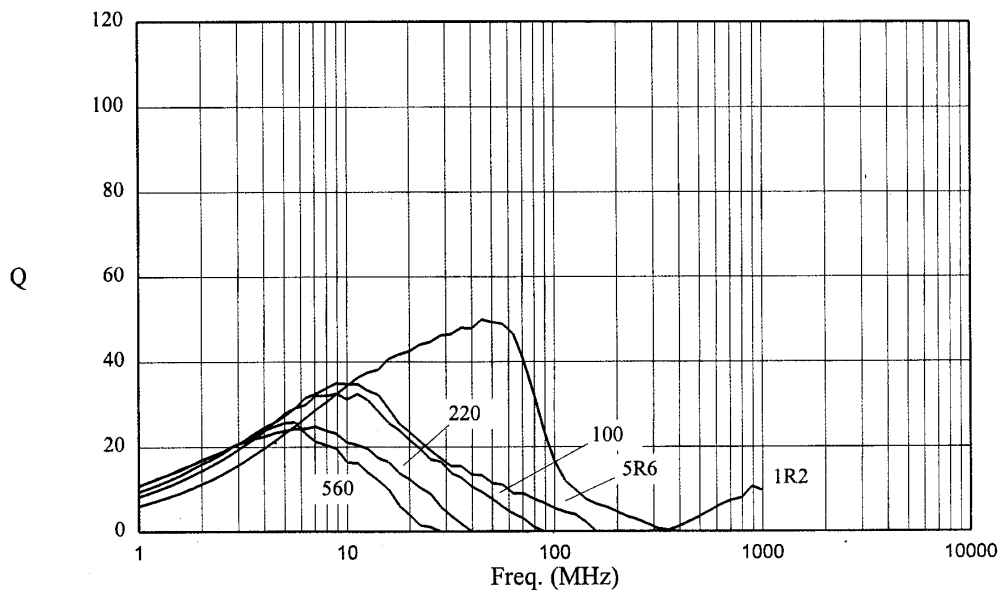

AE-001A

# SPECIFICATION FOR APPROVAL

REF :

PAGE: 4

PROD. NAME	WOUND CHIP INDUCTOR	ABC'S DWG NO.	SW2520□□□□2□
		ABC'S ITEM NO.	

**PACKAGING INFORMATION :**

( 1 ) Configuration

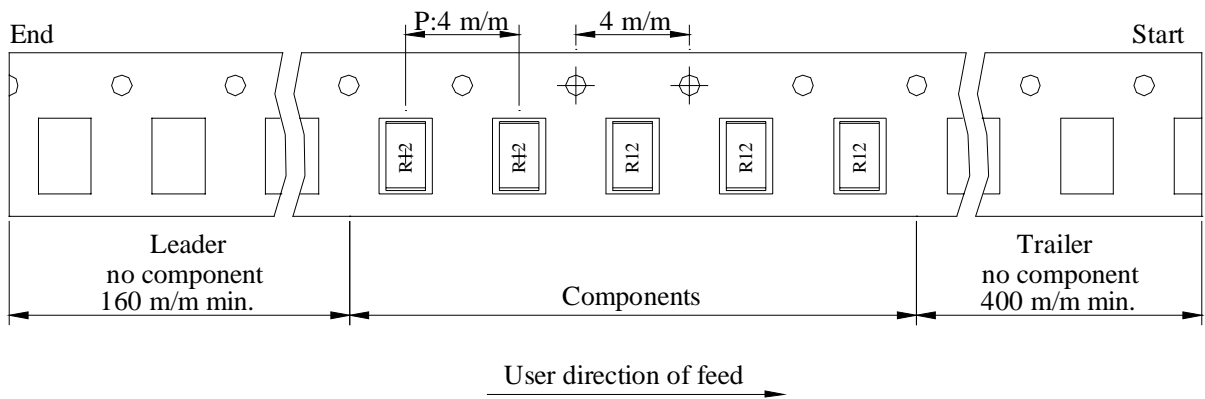
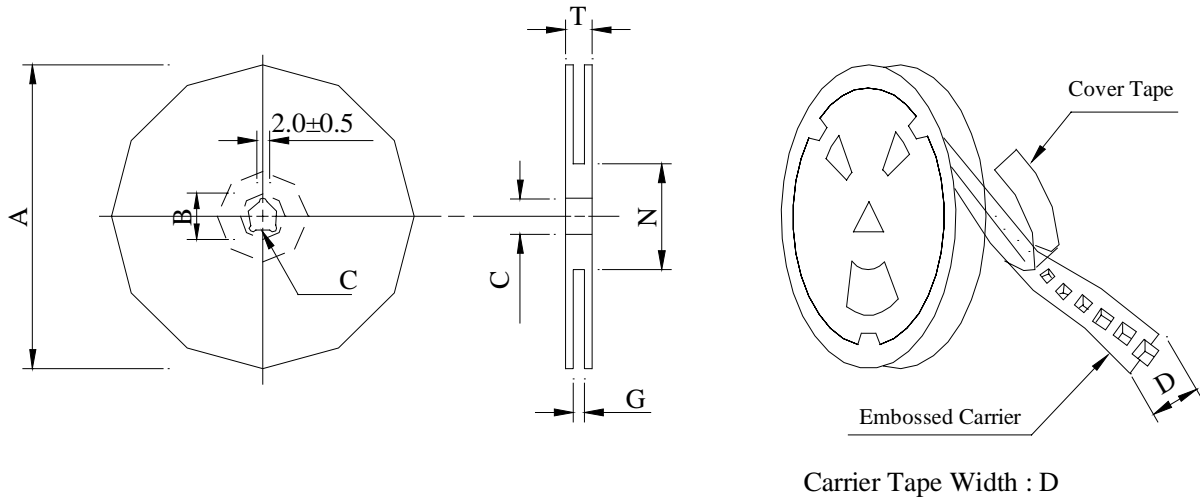

( 2 ) Dimensions

Unit:m/m

Style	A	B	C	D	G	N	T
07 - 08	178	21±0.8	13	8	10 <sup>+0</sup>	50 <sup>-0</sup>	12.5

( 2 ) Q'TY & G.W. Per package

Series	Inner : Reel			Outer : Carton		
	Q'TY (pcs)	G.W. (gw)	Style	Q'TY (pcs)	G.W. (Kg)	Size (cm)
SW2520	2,000	95	07 - 08	100,000	6.50	41 x 39 x 22

AE-001A

# SPECIFICATION FOR APPROVAL

REF :

PAGE: 5

PROD. NAME	WOUND CHIP INDUCTOR	ABC'S DWG NO.	SW2520□□□□2□
		ABC'S ITEM NO.	

. DWG EXPRESSION :

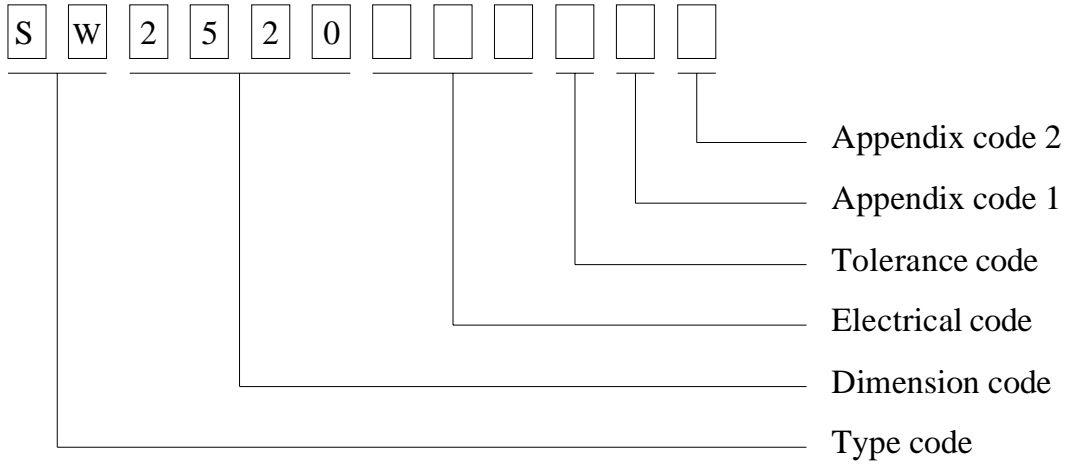

- Appendix code 1 : S : Standard products  
 A K , M R , T Z : Special products  
 L : Standard Lead Free products  
 1 ~ 9 : Special Lead Free products

Appendix code 2 :

Code	Inner package	Inner package Q'TY	Remark
A	Empty	Empty	
B	T / R ( Reel package )	2000 pcs	

# SPECIFICATION FOR APPROVAL

REF :

PAGE: 6

PROD. NAME	WOUND CHIP INDUCTOR	ABC'S DWG NO.	SW2520□□□□2□
		ABC'S ITEM NO.	

**. RELIABILITY TEST :**

Test items	Specifications	Test conditions / Test methods
<i>ELECTRICAL PERFORMANCE TEST</i>		
L	Refer to standard electrical characteristic list	HP-4291A With HP-16193 Test fixture .
Q		HP-4291A With HP-16193 Test fixture.
SRF		HP-8753E
RDC		HP-4338B
Rated current IDC		Applied the current to coils the inductance change shall be less than 10% to initial value and temperature rise shall not be more than 20
Temperature rise test	20 max.	1.Applied the allowed DC current for 10 minutes. 2.Temperature measure by digital surface thermometer .
Over load test	After test , Inductors shall be no evidence of electrical and mechanical damage	Applied 2 times of rated allowed DC current to inductor for a period of five minutes .
Withstanding voltage test	After test , Inductors shall be no evidence of electrical and mechanical damage	500VAC between inductor terminals and center of case for a maximum 1 minute.
Insulation resistance test	1000 MΩ min.	100 VDC between inductor terminals and center case.
<i>MECHANICAL PERFORMANCE TEST</i>		
Vibration test (Low frequency)	1. There shall be no case deformation or change in appearance. 2. Inductance shall not change more than ±5%	1. Amplitude : 1.5 m/m 2. Frequency : 10-55-10Hz/min. 3. Direction : X,Y,Z 4. Duration : 2HRS/X,Y,Z
Vibration test (Low frequency )	3.Q shall not change more than±10%	Inductors shall be dropped 10 times from a height of 1m onto 3cm wooden board .
Resistance to soldering heat		Inductors shall be reflowed onto a P.C. board using solder paste. Solder process shall be 230 for 20±2 seconds and 260 for 5±2 seconds
Solderability test	The metalized area must have 90% min. solder coverage	Dip pads in flux (Alpha 100 or equiv.) and dip in solder pot at 230±5 for 5 seconds

AE-001A



# SPECIFICATION FOR APPROVAL

REF :

PAGE: 7

PROD. NAME	WOUND CHIP INDUCTOR	ABC'S DWG NO.	SW2520□□□□2□
		ABC'S ITEM NO.	

Component adhesion (Push test)	20N : 2012 , 2520 , 3225 10N : 1608 5N : 1005	The device shall be reflow soldered (230±5 for 10 seconds) to a tinned copper substrate. A dynamometer force gauge shall be applied to the side of the component . The device must withstand the minimum force indicated at left without a failure of the termination to board attachment.
-----------------------------------	---	--

*CLIMATIC TEST*

Temperature characteristic	1. There shall be no case deformation or change in appearance.	-40 ~125
Humidity test	2. Inductance shall not change more than ±5%	Temp. : 50±2 R.H. : 90~95 % Time. : 96±2 hours
Low temperature storage	3. Q shall not change more than ±10%	Temp. : -40±2 Time. : 48±2 hours
Thermal shock test		-40 for 30 minutes. +125 for 30 minutes. Total : 10 cycles
High temperature storage		Temp. : 125±2 Time. : 48±2 hours

Note : Inductors are to be tested after 1 hour at room temperature.

*LIFE TEST*

High temperature load life test	Inductors shall not have a shorted or open winding.	1. Temp : 85±2 2. Time : 1000±12 hours 3. Load : Allowed DC current
Humidity load life		1. Temp : 40±2 2. R.H. : 90-95% 3. Time : 1000±12 hours 4. Load : Allowed DC current

# SPECIFICATION FOR APPROVAL

REF :

PAGE: 8

PROD. NAME	<b>WOUND CHIP INDUCTOR</b>	ABC'S DWG NO.  ABC'S ITEM NO.	SW2520□□□□2□
---------------	----------------------------	-------------------------------------	--------------

**UL CARD :**

OBMW2 August 27, 1999  
 Magnet Wire-Component  
 ELEKTRISOLA (MALAYSLA) SDN BHD E143312  
 IALAN DAMN SATU IANDA BAIK 28750 BENTONG, PAHANG  
 DARUL MAKMUR MALAYSIA

Mtl Dsg	Mark Dsg	Coating Type		ANSI Typ	Temp Class
		BC	OC		
Estersol 160	E180	Polyesterimide (solderable)	---	MW-77	180
Amldester 200	A200	Polyesterimide	---	MW-74	200
Polysol-N 155	PN155	Polyurechane	Nylon	MW-80, MW-28	155, 100
Polysol 155	P155	Polyurechane	---	MW-79, MW-79	155, 130
Polysol 155g	Pg155	Polyurechane	---	MW-79	130
Polysol 155p	Pp155,Gp155	Polyurechane	---	MW-79	155
Polysol 160	P160	Polyurechane	---	MW-79	155
Polysol 180	P180	Polyurechane	---	MW-79	155
Polysol 170	P170 or G170	Polyurechane	---	MW-79	156
Polysol-N 180	PN180	Polyurechane	Nylon	---	180

Marking : Dompany name/nateriel designation or marked designation and factory identification on package ok reel

See General Information preceding These Recognitions

For use only in equipment where the acceptability of the combination is determined by Underwriters Laboratories Inc.