



**Part No./型号: SL-522UYCAE-C143**

➤ **Features/特征:**

- Single color/单色
- High bright output/高亮度输出
- Low power consumption/低功耗
- High reliability and long life/  
可靠性高、寿命长

➤ **Descriptions/描述:**

- Dice material/芯片材质: AlGaInP
- Emitting Color/发光颜色:  
Super Bright Yellow/ 高亮度黄色
- Device Outline/产品外形:  
φ5mm Round Type/ 5mm 圆形
- Lens Type 胶体颜色:  
Water Clear/ 无色透明

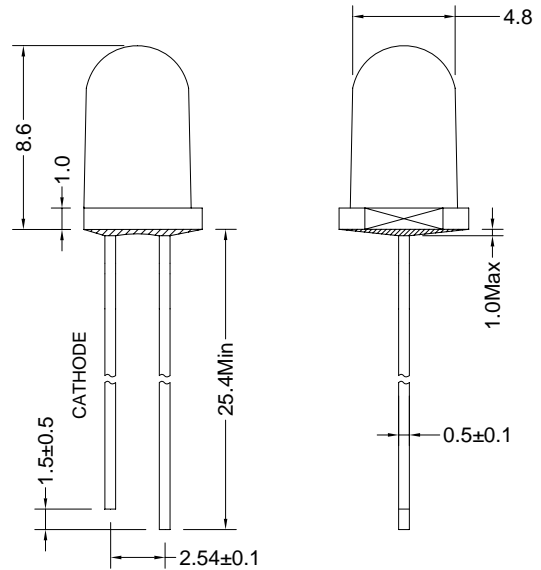
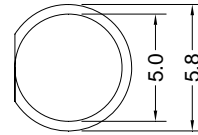

1. All dimensions are millimeters/单位: mm.
2. Tolerance is +/-0.20mm unless otherwise noted/  
没有标注的公差均为±0.20mm.

➤ **Directivity/指向特性:**

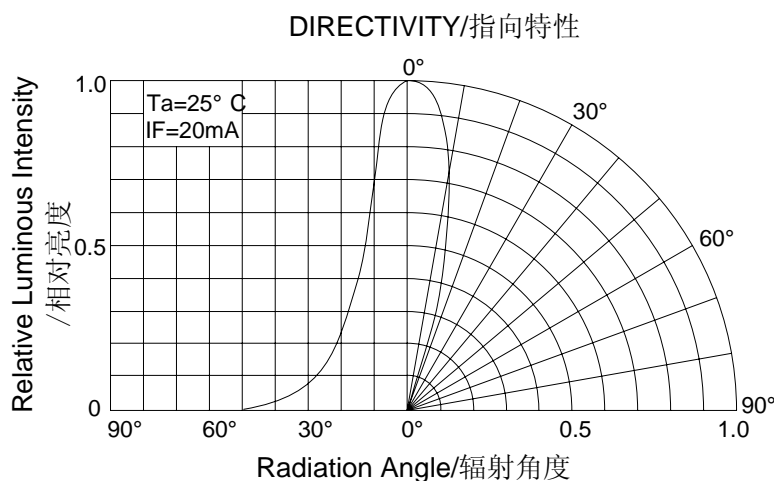



Part No./型号: **SL-522UYCAE-C143**

➤ **Absolute maximum ratings/极限参数 (Ta = 25°C)**

Parameter 参数	Symbol 符号	Test Condition 测试条件	Values 数值		Unit 单位
			Min.	Max.	
Reverse Voltage 反向电压	V <sub>R</sub>	I <sub>R</sub> = 10 μA	5	--	V
Forward Current 正向工作电流	I <sub>F</sub>	----	----	30	mA
Power Dissipation 损耗功率	P <sub>d</sub>	----	----	75	mW
Pulse Current 正向峰值电流	I <sub>peak</sub>	Duty=0.1mS, 1kHz	----	100	mA
Operating Temperature 工作温度范围	T <sub>opr</sub>	----	-40	+85	°C
Storage Temperature 储存温度范围	T <sub>str</sub>	----	-40	+100	°C

➤ **Electrical and optical characteristics/光电参数 (Ta = 25°C)**

Parameter 参数	Symbol 符号	Test Condition 测试条件	Values 数值			Unit 单位
			Min.	Typ.	Max.	
Forward Voltage 正向电压	V <sub>F</sub>	I <sub>F</sub> =20mA	----	2.1	2.5	V
Reverse Current 反向电流	I <sub>R</sub>	V <sub>R</sub> =5V	----	----	10	μA
Dominate Wavelength 主波长	λ <sub>d</sub>	I <sub>F</sub> =20mA	585	590	595	nm
Peak Wavelength 峰值波长	λ <sub>p</sub>	I <sub>F</sub> =20mA	----	591	----	nm
Spectral Line half-width 半波长宽度	Δλ	I <sub>F</sub> =20mA	----	15	----	nm
Luminous Intensity 发光强度	I <sub>v</sub>	I <sub>F</sub> =20mA	----	4000	----	mcd
Viewing Angle 指向角度	2θ <sub>1/2</sub>	I <sub>F</sub> =20mA	----	26	----	deg.



➤ **Typical electrical/optical characteristic curves/光电特性曲线:**

Fig.1 正向电流 Vs. 正向电压

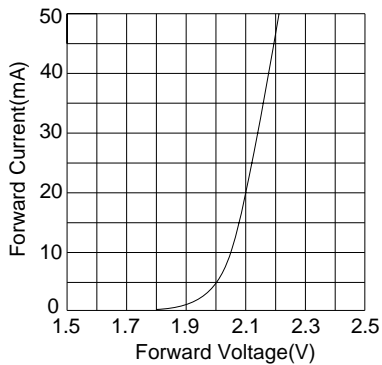

Fig.2 相对亮度 Vs. 正向电流

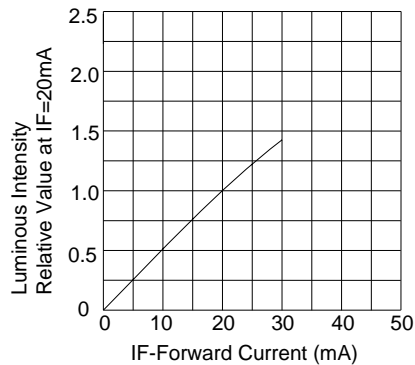

Fig.3 正向电流 Vs. 环境温度

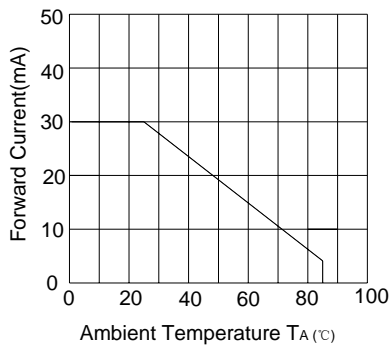

Fig.4 相对亮度 Vs. 环境温度

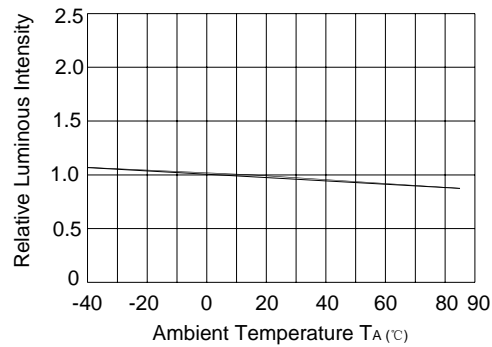
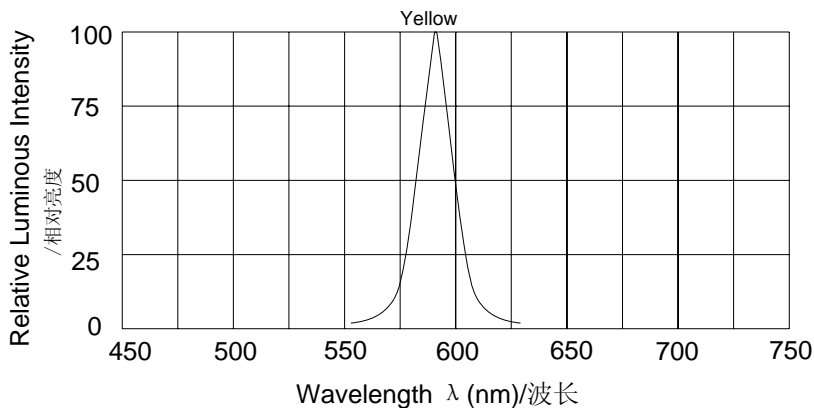

Fig.5 相对亮度 Vs. 波长





**Part No./型号: SL-522UYCAE-C143**

➤ **Reliability Analysis/可靠性试验**

The reliability of products shall be satisfied with items listed below/产品的可靠性应该满足下面列表项目:

Confidence level:90% ; LTPD :10%

● **Test Items And Results/测试项目和判据**

No.	Item/项目	Test Condition/测试条件	Time/时间	Q'ty/数量	Standard/判定
1	Resistance to Soldering Heat / 抗焊接热	Tsld=235±5℃, 5sec 3mm from the base of the epoxy bulb	1 time	25	ALL PASS
2	Solder ability/可焊性	Tsld=235±5℃, 5sec	1times Over 95%	25	ALL PASS
3	Temperature Cycle/ 高低温循环	-40℃—— 100℃ 30min ~ 30min The cut is not more than 2 min	50cycles	100	ALL PASS
4	High Temperature /High Humidity / 高温高湿	85℃/85%RH	1000hrs	100	ALL PASS
5	High Temperature Storage /高温储存	Ta=100℃	1000hrs	100	ALL PASS
6	Low Temperature Storage /低温储存	Ta=-40℃	1000hrs	100	ALL PASS
7	DC Operation Life / 寿命测试	IF=20mA	1000hrs	25	ALL PASS

● **Criteria For Judging Damage/判断标准**

Item/项目	Symbol/符号	Test conditions /测试条件	Criteria for Judgement /判断标准	
			Min./最小值	Max./最大值
Luminous Intensity/亮度	Iv	IF=20mA	Iv*0.7	/
Forward Voltage/正向电压	VF	IF=20mA	/	U.S.L*1.1
Reverse current/反向电流	IR	VR=5v	/	U.S.L*2

\*U.S.L.: Upper Standard Level / 上限

\*L.S.L.: Lower Standard Level / 下限



**Part No./型号: SL-522UYCAE-C143**

➤ **Label Form Specification/标签格式规范**

	升谱光电 SUNPU OPTO
P/N:	_____
Rank:	_____/_____/_____/_____
Qty:	_____ pcs
QC:	_____
Date:	_____
Lot No:	_____
	

P/N: Customer's Production Number/产品编号

QTY: Packing Quantity/包装数量

Ranks: Iv / WD/ Vf

Iv: Iv Rank/亮度; WD: Color Group/色系; Vf: Vf Rank/电压

QC: Quality Control chapter/质量控制章

Date: mm / dd / yy

mm: Month/月; dd: Date/日; yy: Year/年;

Lot No: Production batch Number/生产批号

➤ **Lead Forming/成形**

1. Any lead forming or bending must be done before soldering.

支架成形必须在焊接前完成。

2. When forming leads, there must be a minimum of 2mm clearance between the base of the LED lens and the lead bend.

必需离胶体 2 毫米才能折弯支架。

3. Avoid bending the leads at the same point more than once.



**Part No./型号: SL-522UYCAE-C143**

避免在管脚同一位置两次或多次弯。

4. During assembly onto PCB, the lead pitch of the LED must match the pitch of the mounting holes on the PCB during component placement.

支架成形需保证引脚和间距与线路板上一致。

➤ **Soldering Condition/焊接条件**

Careful attention should be paid during soldering. When soldering, leave more than 2mm from solder joint to case, and soldering beyond the base of the tie bar is recommended.

焊接时请特别注意，焊接点要离LED封装体底部2mm以上。

Avoiding applying any stress to the lead frame while the LEDs are at high temperature particularly when soldering.

在LED处于高温，特别是在焊接时，请避免对支架施压。

**Recommended soldering conditions/推荐焊接条件:**

Hand Soldering 手工焊接		DIP Soldering 浸焊	
Temp.at tip of iron 电烙铁温度	300°C Max.(30WMax.) 最高温度300°C (功率不超过30瓦)	Preheat temp. 预热温度	100°C Max. (60 sec Max.) 最高温度100°C (不超过60秒)
Soldering time 焊接时间	3 sec Max. 时间不超过3秒	Bath temp. 浸焊温度	260°C Max 最高260°C.
Distance 焊接位置	2mm Min.(From solder joint to case) 大于2毫米(从焊点到胶体)	Bath time. 浸焊时间	3 sec Max. 不超过3秒
		Distance 浸焊位置	2mm Min 大于2毫米.

➤ **Cleaning/清洗**

1. Do not clean LEDs with water, Alcohol are recommended solvents for cleaning. When using other solvents, it should be confirmed beforehand whether the solvents will dissolve the resin or not.



**Part No./型号: SL-522UYCAE-C143**

不要用水清洗，推荐使用酒精清洗，当使用其他溶剂清洗时应事先确认该溶剂是否溶解树脂。

2. LEDs may be damaged by ultrasonic-washed. Before cleaning, a pre-test should be done to confirm whether any damage to the LEDs will occur.

LED有可能在超声波清洗过程中被破坏。为了保证安全，在清洗前，请先确认。

➤ **Storage/保存**

1. Environmental temperature: -40°C---100°C, Recommended: -20°C---50°C

环境温度：-40°C---100°C，推荐使用-20°C---50°C；

2. Environmental humidity: 30%---70%, Recommended: 40%---60%

环境湿度：30%---70%，推荐使用40%---60%；

➤ **Static Electricity/静电**

1. Static Electricity or power surge will damage the LED.

It is recommended that a wrist band or an anti-electrostatic glove be used when handling the LEDs.

静电或激增电压将损害 LED。

建议使用发光二极管时佩戴手腕带或防静电手套。

2. All production machinery and test instruments must be electrically grounded.

所有的生产机器和检测仪器，必须接地。

3. Maintain a humidity level of 50% or higher in production areas.

生产现场湿度必须保持在50%或者更高。

4. Use anti-static packaging for transport and storage.

使用防静电包装，运输和储存。



➤ **Notes/备注**

1. This datasheet will be update regularly, if there comes out any changes, pls confirmed by the latest datasheet.

以上规格书会定期进行更新，如有改动,以最新规格书为准。

2. When using this product, please observe the absolute maximum ratings and the instructions for using outlined in these specification sheets. SUNPU assumes no responsibility for any damage resulting from use of the product which does not comply with the absolute maximum ratings and the instructions included in these specification sheets.

在使用本产品时，请注意参考规格书中的最大额定值和使用说明，如果没有遵照产品规格书中的最大额定值以及使用说明而产生的不良后果，不在升谱承诺范围之内。