

Optocoupler, Phototransistor Output, with Base Connection

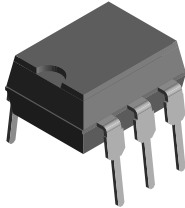

1179004

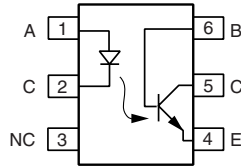

FEATURES

- Isolation test voltage 5300 V_{RMS}
- Long term stability
- Industry standard dual-in-line package
- Lead (Pb)-free component
- Component in accordance to RoHS 2002/95/EC and WEEE 2002/96/EC



RoHS
COMPLIANT

DESCRIPTION

The CNY17 is an optically coupled pair consisting of a gallium arsenide infrared emitting diode optically coupled to a silicon NPN phototransistor.

Signal information, including a DC level, can be transmitted by the device while maintaining a high degree of electrical isolation between input and output.

The CNY17 can be used to replace relays and transformers in many digital interface applications, as well as analog applications such as CRT modulation.

AGENCY APPROVALS

- Underwriters lab file no. E52744 system code H or J
- DIN EN 60747-5-5
- BSI IEC 60950, IEC 60065
- FIMKO

ORDER INFORMATION	
PART	REMARKS
CNY17-1	CTR 40 to 80 %, DIP-6
CNY17-2	CTR 63 to 125 %, DIP-6
CNY17-3	CTR 100 to 200 %, DIP-6
CNY17-4	CTR 160 to 320 %, DIP-6
CNY17-1X006	CTR 40 to 80 %, DIP-6 400 mil (option 6)
CNY17-1X007	CTR 40 to 80 %, SMD-6 (option 7)
CNY17-1X009	CTR 40 to 80 %, SMD-6 (option 9)
CNY17-2X006	CTR 63 to 125 %, DIP-6 400 mil (option 6)
CNY17-2X007	CTR 63 to 125 %, SMD-6 (option 7)
CNY17-2X009	CTR 63 to 125 %, SMD-6 (option 9)
CNY17-3X006	CTR 100 to 200 %, DIP-6 400 mil (option 6)
CNY17-3X007	CTR 100 to 200 %, SMD-6 (option 7)
CNY17-3X009	CTR 100 to 200 %, SMD-6 (option 9)
CNY17-4X006	CTR 160 to 320 %, DIP-6 400 mil (option 6)
CNY17-4X007	CTR 160 to 320 %, SMD-6 (option 7)
CNY17-4X009	CTR 160 to 320 %, SMD-6 (option 9)

Note

For additional information on the available options refer to option information.

ABSOLUTE MAXIMUM RATINGS				
PARAMETER	TEST CONDITION	SYMBOL	VALUE	UNIT
INPUT				
Reverse voltage		V _R	6.0	V
Forward current		I _F	60	mA
Surge current	t ≤ 10 μs	I _{FSM}	2.5	A
Power dissipation		P _{diss}	100	mW



ABSOLUTE MAXIMUM RATINGS				
PARAMETER	TEST CONDITION	SYMBOL	VALUE	UNIT
OUTPUT				
Collector emitter breakdown voltage		BV_{CEO}	70	V
Emitter base breakdown voltage		BV_{EBO}	7.0	V
Collector current		I_C	50	mA
	$t < 1.0$ ms	I_C	100	mA
Power dissipation		P_{diss}	150	mW
COUPLER				
Isolation test voltage between emitter and detector referred to climate DIN 50014, part 2, Nov. 74	$t = 1.0$ s	V_{ISO}	5300	V_{RMS}
Creepage distance			≥ 7.0	mm
Clearance distance			≥ 7.0	mm
Isolation thickness between emitter and detector			≥ 0.4	mm
Comparative tracking index per DIN IEC 112/VDE 0303, part 1			175	
Isolation resistance	$V_{IO} = 500$ V, $T_{amb} = 25$ °C	R_{IO}	$\geq 10^{12}$	Ω
	$V_{IO} = 500$ V, $T_{amb} = 100$ °C	R_{IO}	$\geq 10^{11}$	Ω
Storage temperature		T_{stg}	- 55 to + 150	°C
Operating temperature		T_{amb}	- 55 to + 100	°C
Soldering temperature	max. 10 s, dip soldering: distance to seating plane ≥ 1.5 mm	T_{sld}	260	°C

Note

$T_{amb} = 25$ °C, unless otherwise specified.

Stresses in excess of the absolute maximum ratings can cause permanent damage to the device. Functional operation of the device is not implied at these or any other conditions in excess of those given in the operational sections of this document. Exposure to absolute maximum ratings for extended periods of the time can adversely affect reliability.

ELECTRICAL CHARACTERISTICS							
PARAMETER	TEST CONDITION	PART	SYMBOL	MIN.	TYP.	MAX.	UNIT
INPUT							
Forward voltage	$I_F = 60$ mA		V_F		1.25	1.65	V
Breakdown voltage	$I_R = 10$ mA		V_{BR}	6.0			V
Reverse current	$V_R = 6.0$ V		I_R		0.01	10	μ A
Capacitance	$V_R = 0$ V, $f = 1.0$ MHz		C_O		25		pF
Thermal resistance			R_{th}		750		K/W
OUTPUT							
Collector emitter capacitance	$V_{CE} = 5.0$ V, $f = 1.0$ MHz		C_{CE}		5.2		pF
Collector base capacitance	$V_{CB} = 5.0$ V, $f = 1.0$ MHz		C_{CB}		6.5		pF
Emitter base capacitance	$V_{EB} = 5.0$ V, $f = 1.0$ MHz		C_{EB}		7.5		pF
Thermal resistance			R_{th}		500		K/W
COUPLER							
Collector emitter, saturation voltage	$V_F = 10$ mA, $I_C = 2.5$ mA		V_{CEsat}		0.25	0.4	V
Coupling capacitance			C_C		0.6		pF
Collector emitter, leakage current	$V_{CE} = 10$ V	CNY17-1	I_{CEO}		2.0	50	nA
		CNY17-2	I_{CEO}		2.0	50	nA
		CNY17-3	I_{CEO}		5.0	100	nA
		CNY17-4	I_{CEO}		5.0	100	nA

Note

$T_{amb} = 25$ °C, unless otherwise specified.

Minimum and maximum values were tested requirements. Typical values are characteristics of the device and are the result of engineering evaluations. Typical values are for information only and are not part of the testing requirements.

CURRENT TRANSFER RATIO							
PARAMETER	TEST CONDITION	PART	SYMBOL	MIN.	TYP.	MAX.	UNIT
I_C/I_F	$V_{CE} = 5.0\text{ V}, I_F = 10\text{ mA}$	CNY17-1	CTR	40		80	%
		CNY17-2	CTR	63		125	%
		CNY17-3	CTR	100		200	%
		CNY17-4	CTR	160		320	%
	$V_{CE} = 5.0\text{ V}, I_F = 1\text{ mA}$	CNY17-1	CTR	13	30		%
		CNY17-2	CTR	22	45		%
		CNY17-3	CTR	34	70		%
		CNY17-4	CTR	56	90		%

Note

Current transfer ratio and collector-emitter leakage current by dash number (T_{amb} °C).

SWITCHING CHARACTERISTICS							
PARAMETER	TEST CONDITION	PART	SYMBOL	MIN.	TYP.	MAX.	UNIT
LINEAR OPERATION (WITHOUT SATURATION)							
Turn-on time	$I_F = 10\text{ mA}, V_{CC} = 5.0\text{ V}, R_L = 75\ \Omega$		t_{on}		3.0		μs
Rise time	$I_F = 10\text{ mA}, V_{CC} = 5.0\text{ V}, R_L = 75\ \Omega$		t_r		2.0		μs
Turn-off time	$I_F = 10\text{ mA}, V_{CC} = 5.0\text{ V}, R_L = 75\ \Omega$		t_{off}		2.3		μs
Fall time	$I_F = 10\text{ mA}, V_{CC} = 5.0\text{ V}, R_L = 75\ \Omega$		t_f		2.0		μs
Cut-off frequency	$I_F = 10\text{ mA}, V_{CC} = 5.0\text{ V}, R_L = 75\ \Omega$		f_{CO}		250		kHz
SWITCHING OPERATION (WITH SATURATION)							
Turn-on time	$I_F = 20\text{ mA}$	CNY17-1	t_{on}		3.0		μs
	$I_F = 10\text{ mA}$	CNY17-2	t_{on}		4.2		μs
		CNY17-3	t_{on}		4.2		μs
	$I_F = 5\text{ mA}$	CNY17-4	t_{on}		6.0		μs
Rise time	$I_F = 20\text{ mA}$	CNY17-1	t_r		2.0		μs
	$I_F = 10\text{ mA}$	CNY17-2	t_r		3.0		μs
		CNY17-3	t_r		3.0		μs
	$I_F = 5\text{ mA}$	CNY17-4	t_r		4.6		μs
Turn-off time	$I_F = 20\text{ mA}$	CNY17-1	t_{off}		18		μs
	$I_F = 10\text{ mA}$	CNY17-2	t_{off}		23		μs
		CNY17-3	t_{off}		23		μs
	$I_F = 5\text{ mA}$	CNY17-4	t_{off}		25		μs
Fall time	$I_F = 20\text{ mA}$	CNY17-1	t_f		11		μs
	$I_F = 10\text{ mA}$	CNY17-2	t_f		14		μs
		CNY17-3	t_f		14		μs
	$I_F = 5\text{ mA}$	CNY17-4	t_f		15		μs

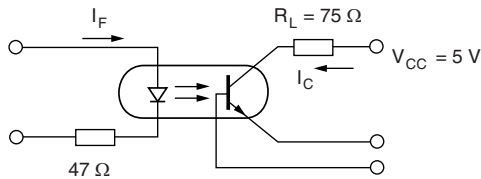
TYPICAL CHARACTERISTICS
 $T_{amb} = 25\text{ }^{\circ}\text{C}$, unless otherwise specified

icny17_01

Fig. 1 Linear Operation (without Saturation)

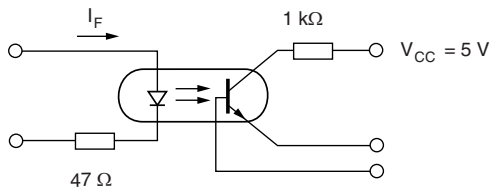

icny17_02

Fig. 2 Switching Operation (with Saturation)

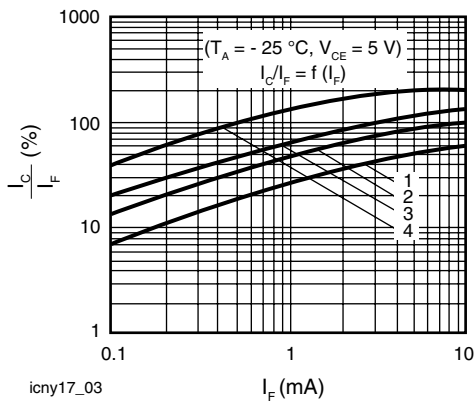

icny17_03

Fig. 3 Current Transfer Ratio vs. Diode Current

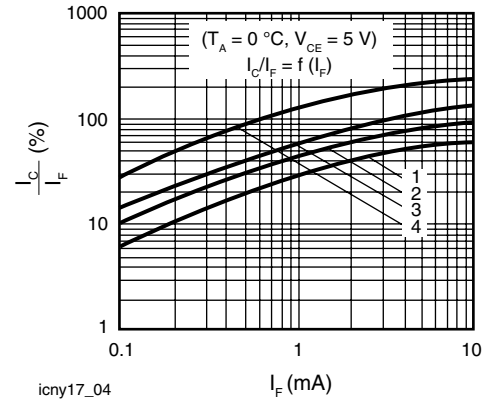

icny17_04

Fig. 4 Current Transfer Ratio vs. Diode Current

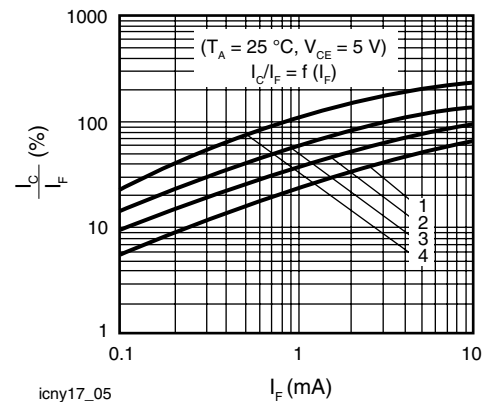

icny17_05

Fig. 5 Current Transfer Ratio vs. Diode Current

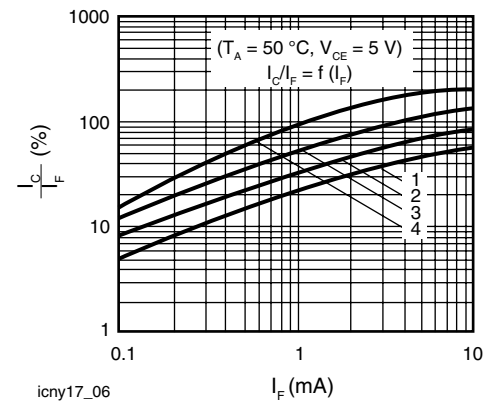

icny17_06

Fig. 6 Current Transfer Ratio vs. Diode Current

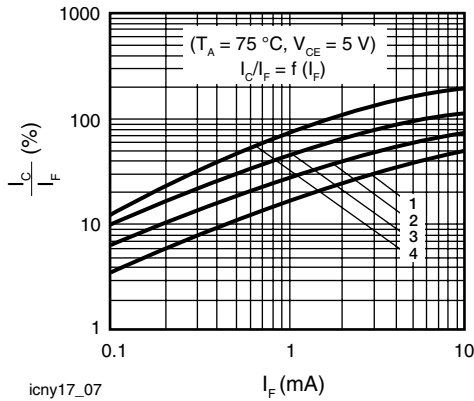

icny17_07

Fig. 7 Current Transfer Ratio vs. Diode Current

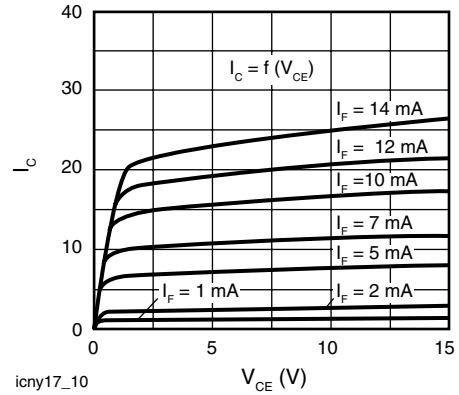

icny17_10

Fig. 10 Output Characteristics

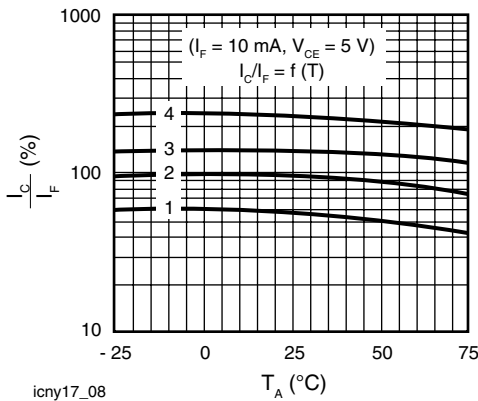

icny17_08

Fig. 8 Current Transfer Ratio (CTR) vs. Temperature

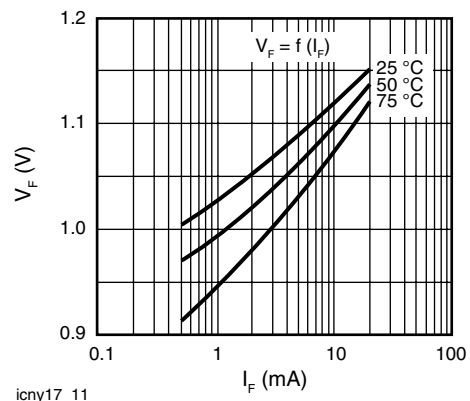

icny17_11

Fig. 11 Forward Voltage

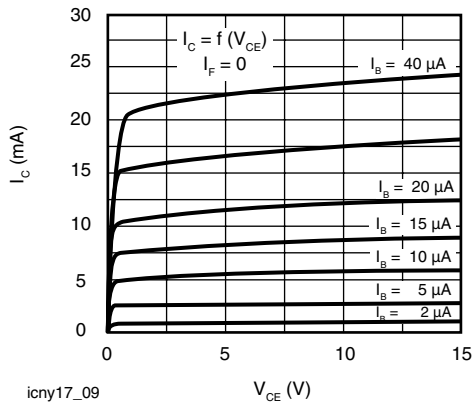

icny17_09

Fig. 9 Transistor Characteristics

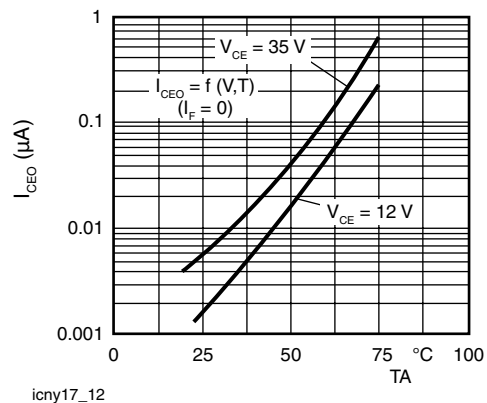

icny17_12

Fig. 12 Collector Emitter Off-state Current

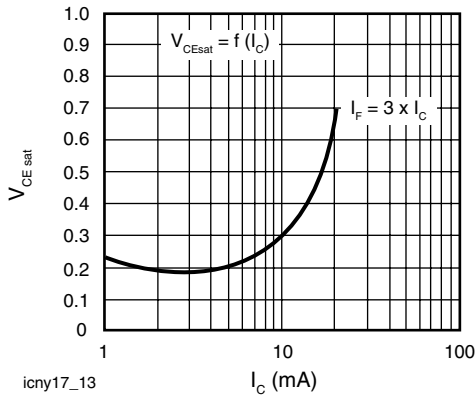

Fig. 13 Saturation Voltage vs. Collector Current and Modulation Depth CNY17-1

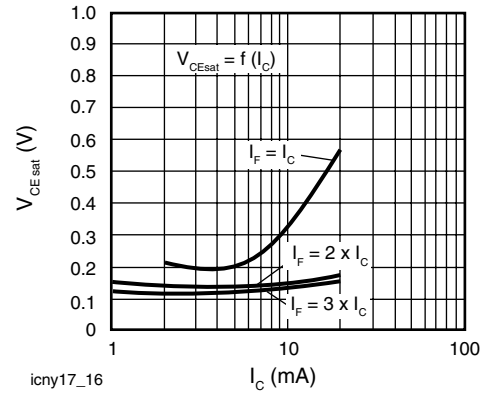

Fig. 16 Saturation Voltage vs. Collector Current and Modulation Depth CNY17-4

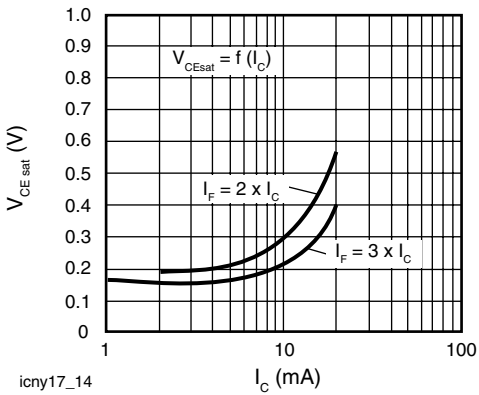

Fig. 14 Saturation Voltage vs. Collector Current and Modulation Depth CNY17-2

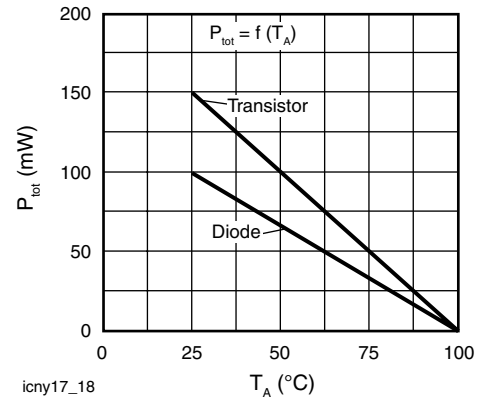

Fig. 17 Permissible Power Dissipation for Transistor and Diode

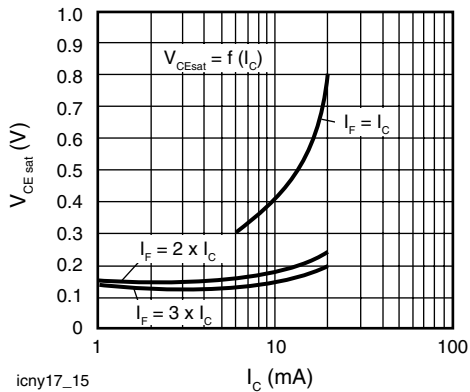
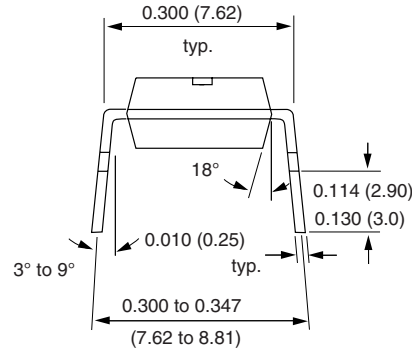
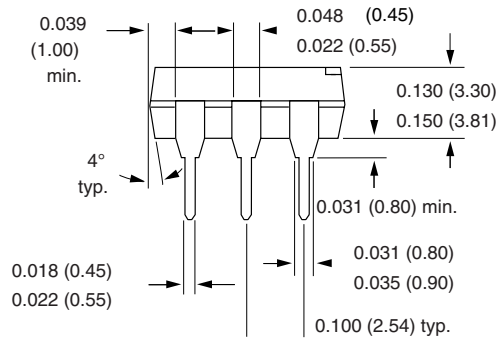
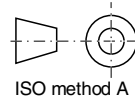
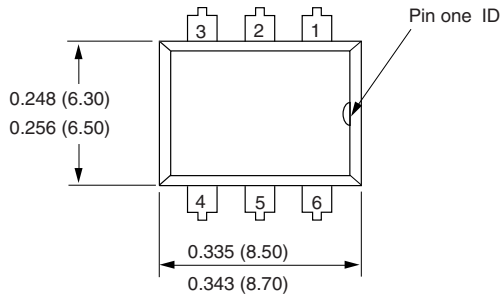

Fig. 15 Saturation Voltage vs. Collector Current and Modulation Depth CNY17-3

PACKAGE DIMENSIONS in inches (millimeters)



i178004

Option 6

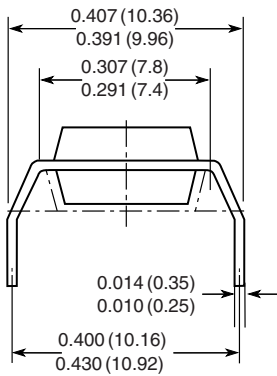

Option 7

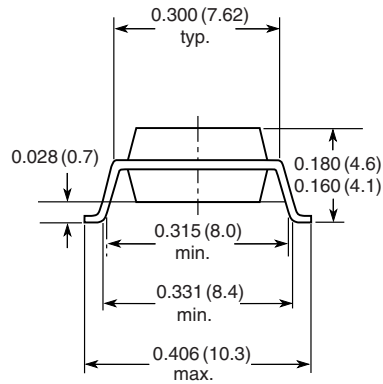

Option 9

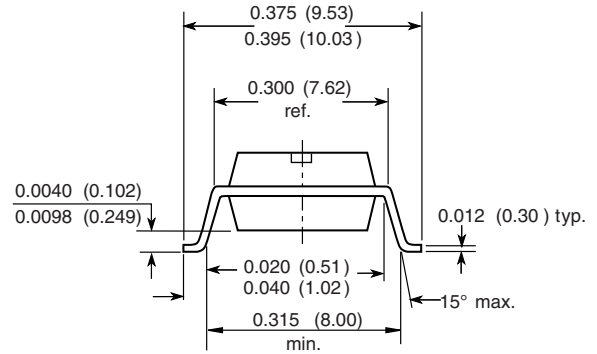

18450

**OZONE DEPLETING SUBSTANCES POLICY STATEMENT**

It is the policy of Vishay Semiconductor GmbH to

1. Meet all present and future national and international statutory requirements.
2. Regularly and continuously improve the performance of our products, processes, distribution and operating systems with respect to their impact on the health and safety of our employees and the public, as well as their impact on the environment.

It is particular concern to control or eliminate releases of those substances into the atmosphere which are known as ozone depleting substances (ODSs).

The Montreal Protocol (1987) and its London Amendments (1990) intend to severely restrict the use of ODSs and forbid their use within the next ten years. Various national and international initiatives are pressing for an earlier ban on these substances.

Vishay Semiconductor GmbH has been able to use its policy of continuous improvements to eliminate the use of ODSs listed in the following documents.

1. Annex A, B and list of transitional substances of the Montreal Protocol and the London Amendments respectively.
2. Class I and II ozone depleting substances in the Clean Air Act Amendments of 1990 by the Environmental Protection Agency (EPA) in the USA
3. Council Decision 88/540/EEC and 91/690/EEC Annex A, B and C (transitional substances) respectively.

Vishay Semiconductor GmbH can certify that our semiconductors are not manufactured with ozone depleting substances and do not contain such substances.

We reserve the right to make changes to improve technical design
and may do so without further notice.

Parameters can vary in different applications. All operating parameters must be validated for each customer application by the customer. Should the buyer use Vishay Semiconductors products for any unintended or unauthorized application, the buyer shall indemnify Vishay Semiconductors against all claims, costs, damages, and expenses, arising out of, directly or indirectly, any claim of personal damage, injury or death associated with such unintended or unauthorized use.

Vishay Semiconductor GmbH, P.O.B. 3535, D-74025 Heilbronn, Germany



Notice

Specifications of the products displayed herein are subject to change without notice. Vishay Intertechnology, Inc., or anyone on its behalf, assumes no responsibility or liability for any errors or inaccuracies.

Information contained herein is intended to provide a product description only. No license, express or implied, by estoppel or otherwise, to any intellectual property rights is granted by this document. Except as provided in Vishay's terms and conditions of sale for such products, Vishay assumes no liability whatsoever, and disclaims any express or implied warranty, relating to sale and/or use of Vishay products including liability or warranties relating to fitness for a particular purpose, merchantability, or infringement of any patent, copyright, or other intellectual property right.

The products shown herein are not designed for use in medical, life-saving, or life-sustaining applications. Customers using or selling these products for use in such applications do so at their own risk and agree to fully indemnify Vishay for any damages resulting from such improper use or sale.