



SPEC NO.: SSR-109M

## **SPECIFICATION**

TO:STE79

Model Name: SAW RESONATOR

**PART NO: SSR380N01S5050**

CUSTOMER PART NO.:

---

**STRONG ELECTRONICS&TECHNOLOGY LIMITED**

---

深圳市思硕电子科技有限公司

Tel:86-755-84528985 28471505 Fax: 86-755-84528986

Email:info@strongelectronics.net

www.sawfilter.cn

**1. Package Dimension**

(S5050)

Unit: mm

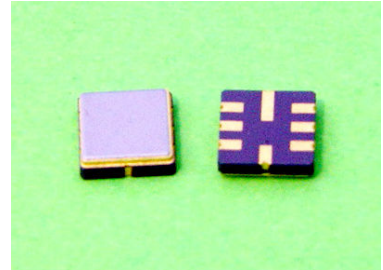
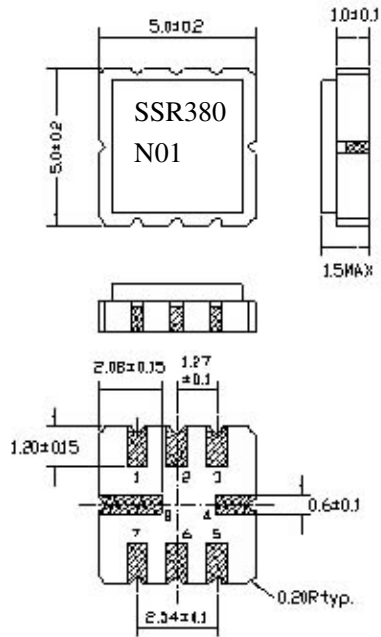

Pin No.	Function
Pin 2	Input
Pin 6	Output
Other	Ground

**2. Marking**

SSR  
380N01

•

- (1) Ink Marking or Laser Marking
- (2) SSR: STRONG LOGO
- (3) 380: Model code
- (4) • : Pin 1 Identifier
- (5) N01: Tolerance code (+/-75KHz)
- (6) H6: Date code

H	6
Month code	Last figure of year

Month	1	2	3	4	5	6	7	8	9	10	11	12
Month code	A	B	C	D	E	F	G	H	I	J	K	L

e.g.: " H6 " means August of 2006

### 3. Equivalent LC Model

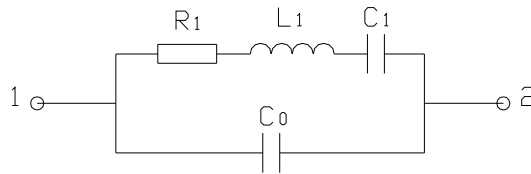

### 4. Performance

#### 4.1 Maximum Rating

Item	Value
Operation Temperature Range	-40□ to +80□
Storage Temperature Range	-45□ to +85□
DC Voltage	10V
Source Power	0 dBm

#### 4.2 Electronic Characteristics

Item	Units	Minimum	Typical	Maximum
Center Frequency (fo)	MHz	379.925	380	380.075
Insertion Loss	dB	—	1.5	2.0
Quality Factor				
Unloaded Q	—	—	11,000	—
50Ω Loaded Q	—	—	2,000	—
Temperature Stability				
Turnover Temperature	□	—	25	—
Freq. Temp. Coefficient	ppm/□	—	0.032	—
Frequency Aging	ppm/yr	—	<±10	—
DC Insulation Resistance	MΩ	1.0	—	—
RF Equivalent RLC Model				
Motional Resistance R1	Ω	—	18	26
Motional Inductance L1	μH	—	86	—
Motional Capacitance C1	fF	—	1.56	—
Shunt Static Capacitance C0	pF	1.7	2.0	2.3

### 4.3 Test Circuit

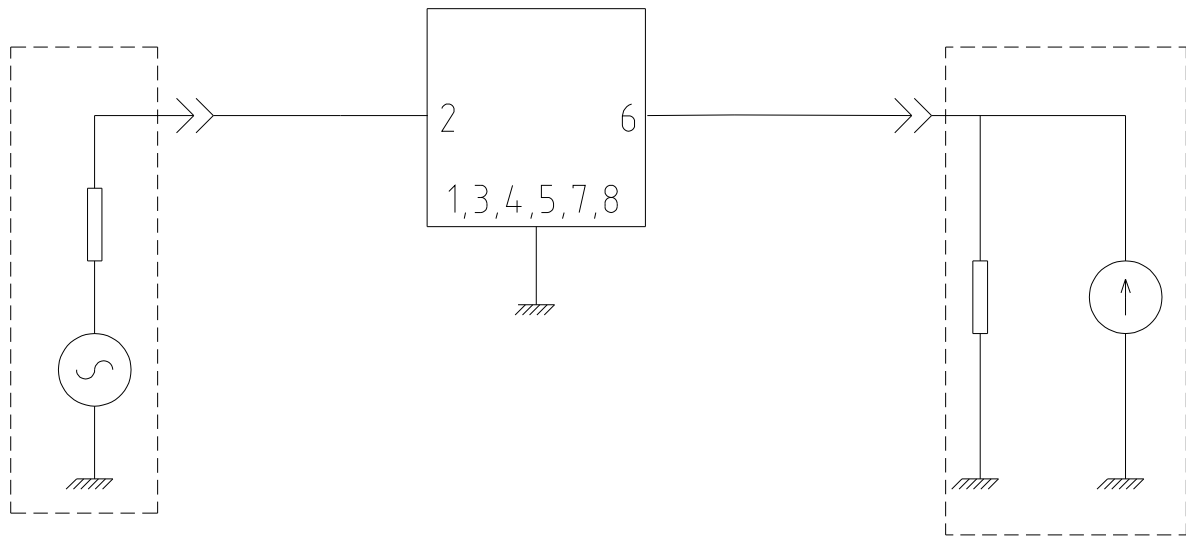

## 5. Reliability

### 5.1 Resistance to Soldering heat:

5.1.1 The components shall remain within the electrical specifications after it soldered on the 1mm-thickness PCB board and dipped in the solder at  $260 \pm 5$  for  $10 \pm 1$  seconds.

5.1.2 The components shall remain within the electrical specifications after it soldered by electric iron, solder at  $350 \pm 10$  for 3~4 seconds, recovery time :  $2h \pm 0.5h$ .

### 5.2 Thermal Shock:

The components shall remain within the electrical specifications after being kept at the condition of heat cycle conditions:  $T_A = -40 \pm 3$ ,  $T_B = 85 \pm 2$ ,  $t_1 = t_2 = 30\text{min}$ , switch time  $\leq 3\text{min}$  & cycle time : 100 times, recovery time :  $2h \pm 0.5h$ .

### 5.3 The Temperature Storage:

5.3.1 High Temperature Storage: The components shall remain within the electrical specifications after being kept at the  $85 \pm 2$  for 500 hours, recovery time :  $2h \pm 0.5h$ .

5.3.2 Low Temperature Storage: The components shall remain within the electrical specifications after being kept at the  $-40 \pm 3$  for 500 hours, recovery time :  $2h \pm 0.5h$ .

### 5.4 Humidity test:

The components shall remain within the electrical specifications after being kept at the condition of ambient temperature  $60 \pm 2$ , and 90~95% RH for 500 hours.

### 5.5 Drop test:

The components shall remain within the electrical specifications after random free drops 10 times from height of 1.0 meter onto concrete floor, and the specimens shall meet the electrical specifications in table 5, external visual inspection.

#### 5.6 Solderability test:

at the condition of temperature  $245^{\circ}\text{C} \pm 5^{\circ}\text{C}$  Depth: DIP 2/3 , SMD 1/5, time: 3.0s-5.0s, 80% or more of the immersed surface shall be covered with solder and well-proportioned.

#### 5.7 Vibration Fatigue:

The components shall remain within the electrical specifications after loaded vibration at 10~55Hz, amplitude 1.5mm, X, Y, Z, direction, for 2 hours.

#### 5.8 Terminal strength:

The force  $10 \pm 1$  seconds of 19.6N is applied to each terminal, and  $45^{\circ}$  in the same direction 2 times with 2N bending force (Exception: SMD)

#### 5.9 Mechanical Shock:

The components shall remain within the electrical specifications after 1000 shocks, acceleration  $392 \text{ m/s}^2$ , duration 6ms.

## 6. Remarks

#### 6.1 Static voltage

Static voltage between signal load & ground may cause deterioration & destruction of the component. Please avoid static voltage.

#### 6.2 Ultrasonic cleaning

Ultrasonic vibration may cause deterioration & destruction of the component. Please avoid ultrasonic cleaning.

#### 6.3 Soldering

Only leads of component may be soldered. Please avoid soldering another part of component.

## 7.Packing

### 7.1 Dimensions

Carrier Tape: Figure 1

Reel: Figure 2

The product shall be packed properly not to be damaged during transportation and storage.

### 7.2 Reeling Quantity

1,000 pcs/reel

### 7.3 Taping Structure

(1) The tape shall be wound around the reel in the direction shown below.

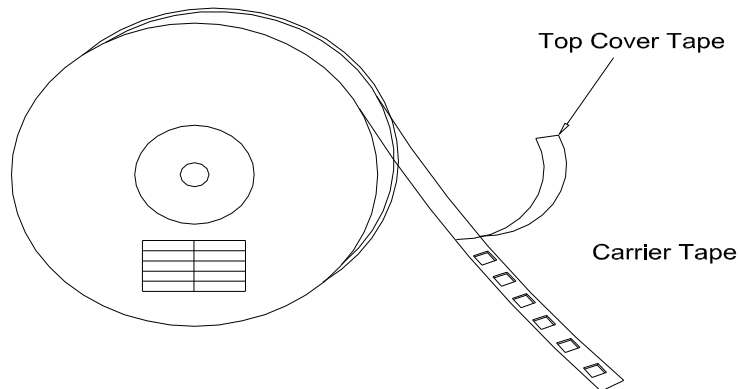

(2) Label

Device Name	
Type	
Quantity	
Lot No.	

(3) Leader part and vacant position specifications.

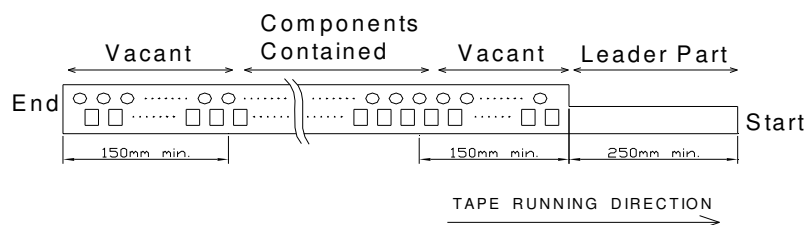

### 8. Tape Specifications

8.1 Tensile Strength of Carrier Tape: 4.4N/mm width

8.2 Top Cover Tape Adhesion (See the below figure)

- (1) pull off angle: 0~15°
- (2) speed: 300mm/min.
- (3) force: 20~70g

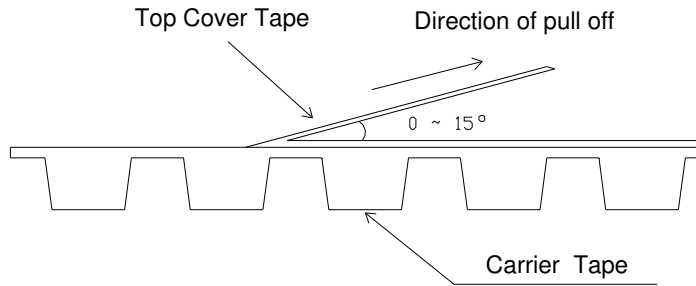

[Figure 1] Carrier Tape Dimensions

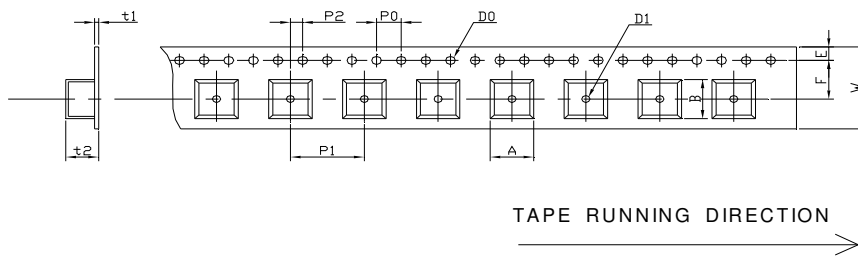

[Unit: mm]

W	F	E	P0	P1	P2	D0	D1	t1	t2	A	B
12.0	5.5	1.75	4.0	8.0	2.0	Φ1.5	Φ1.5	0.31	1.95	5.5	5.5
±0.3	±0.1	±0.1	±0.2	±0.1	±0.2	±0.1	±0.25	max.	max.	max.	max.

[Figure 2] Reel Dimensions

[Unit: mm]

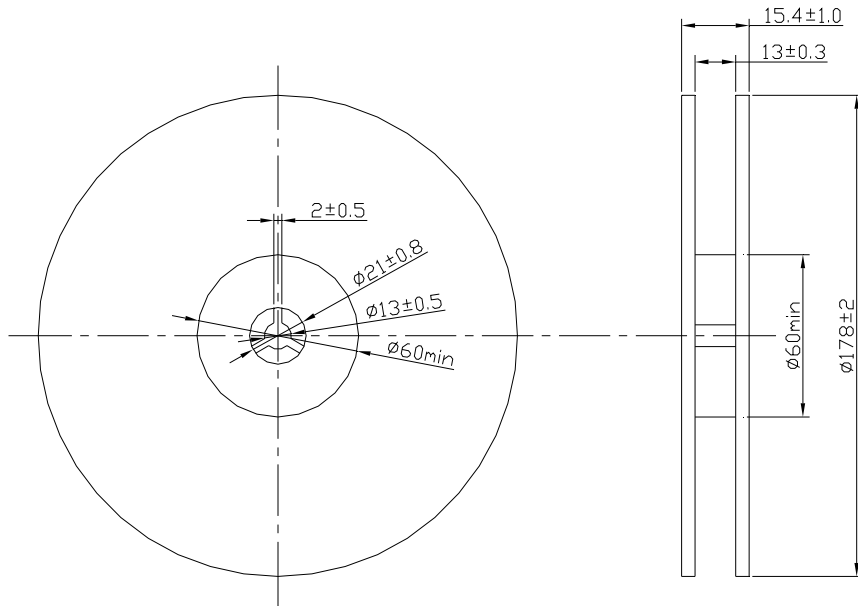

[Figure 3] Part Direction

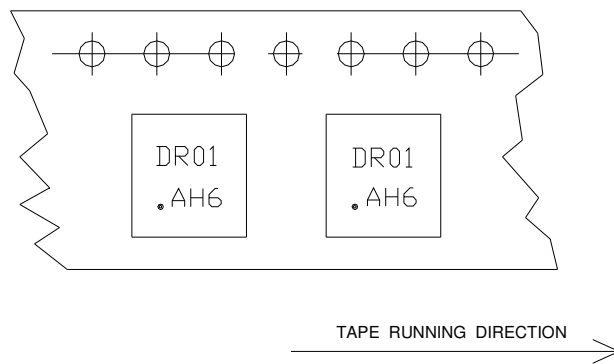

**© Copyright 2006 STRONG, All Rights Reserved**