

比例 1:1

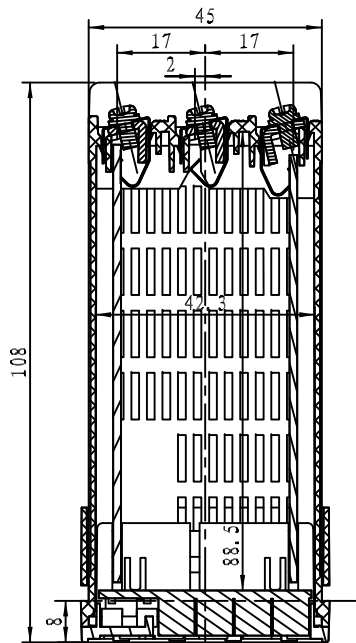

截面 A-A

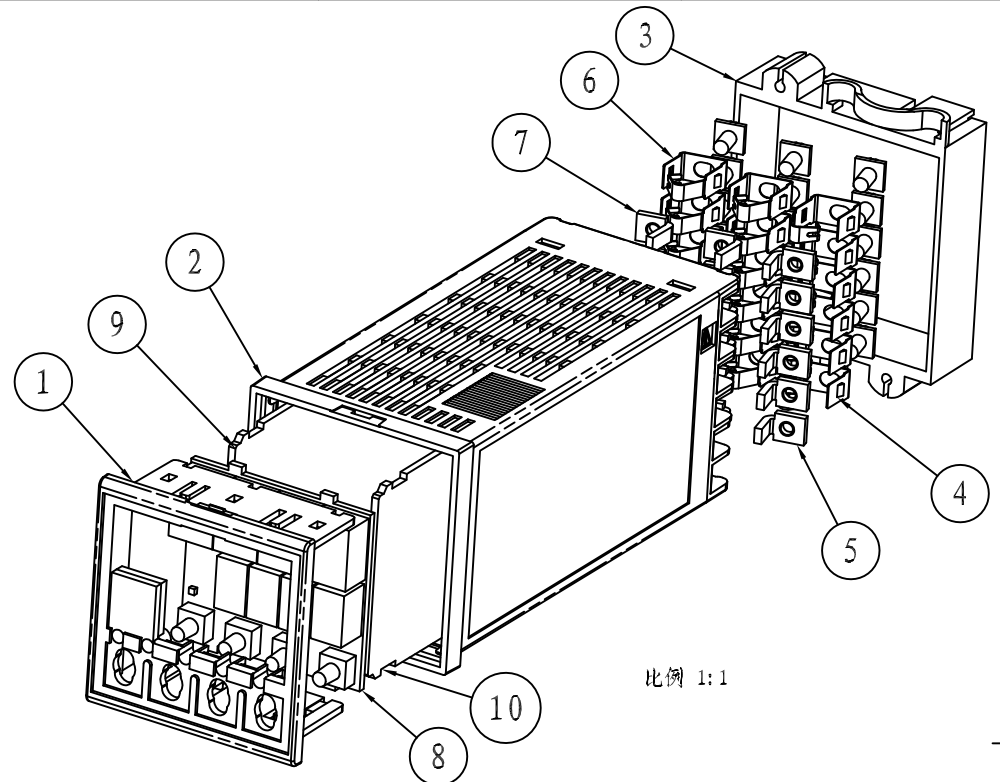

比例 1:1

10	4874-XLB3	线路板	1			
9	4874-XLB2	线路板	1			
8	4874-XLB1	线路板	1			
7	4874-7	内铁片	12	铁皮 (1.5MM)		
6	4874-6	弹片	12	磷铜 (0.25MM)	M3*6 (18个) (组合螺丝6*6)	
5	4874-5	内铁片	6	铁皮 (1.5MM)		
4	4874-4	弹片	6	磷铜 (0.25MM)		
3	4874-3	安装架	1	普通ABS		
2	4874-2	壳体	1	普通ABS		
1	4874-1	面框	1	普通ABS		
序号	编号	名称	数量	材料	单重 (g)	备注
制图	审核	批准	客户名称	材料		
Drawing	Auditing	Confirm	Custom Name	Material		
			产品名称	装配示意图	图纸比例	1:1 A3
			Product Name	Drawing Scale		
			产品编号	视图	第一角投影	(mm)
			Product Code	Project View		
共 1 页		第 1 页		 宁波三和壳体公司 NINGBO SANHE ENCLOSURE CORPORATION		中国宁波慈溪 TEL: +861574163226910 FAX: +861574163226900

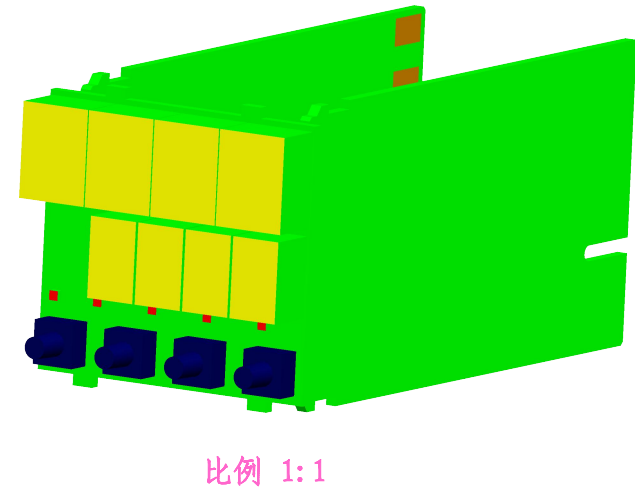
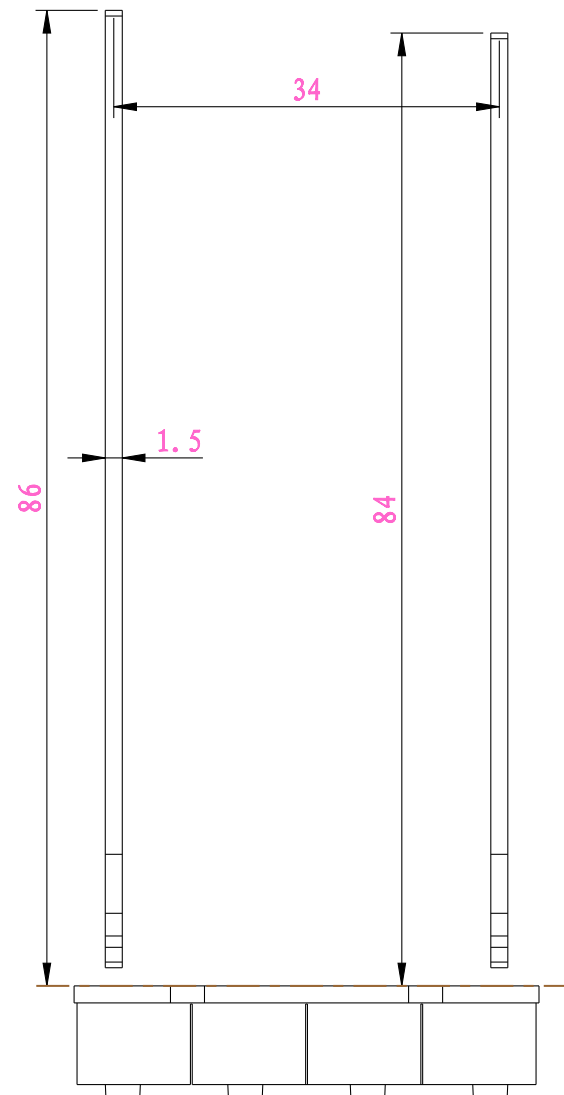
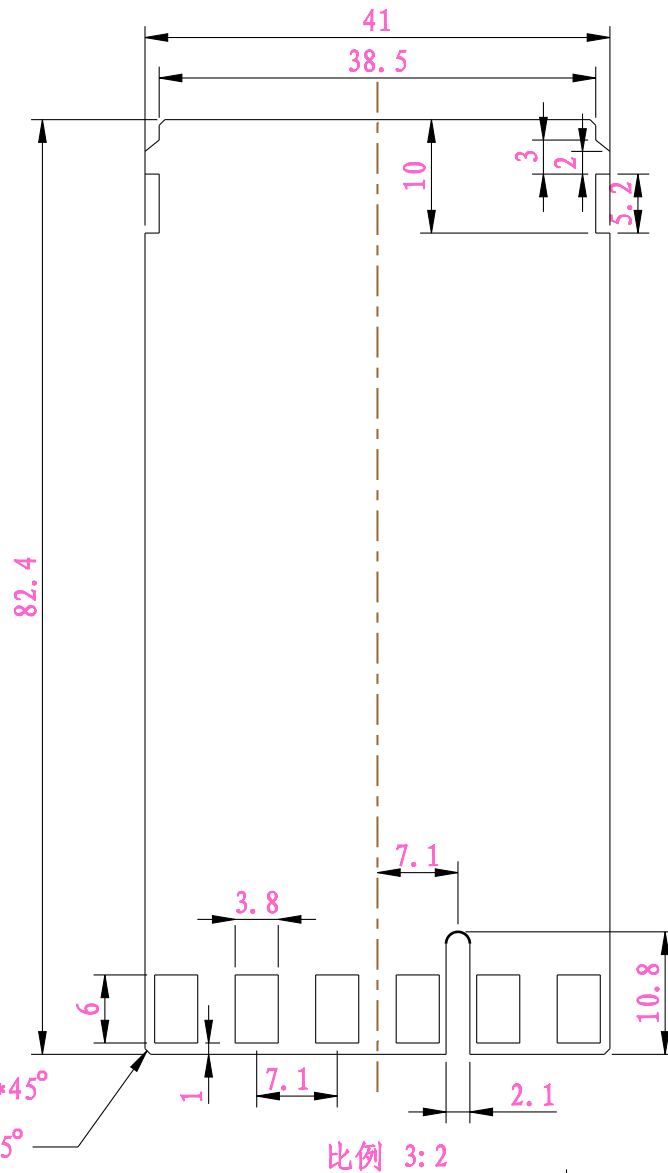
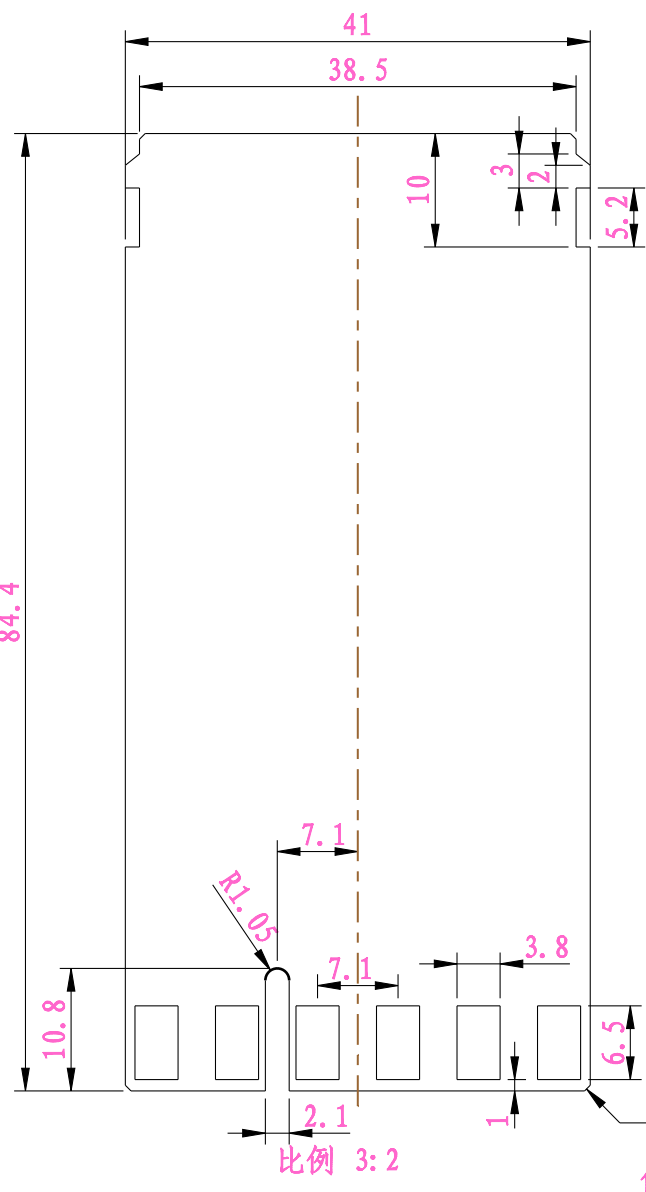
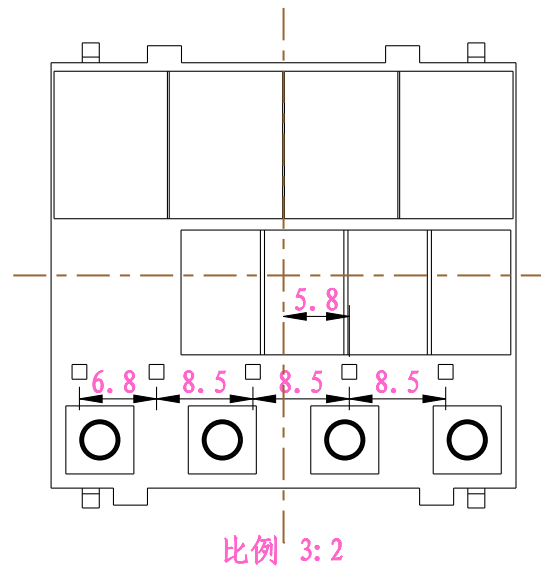
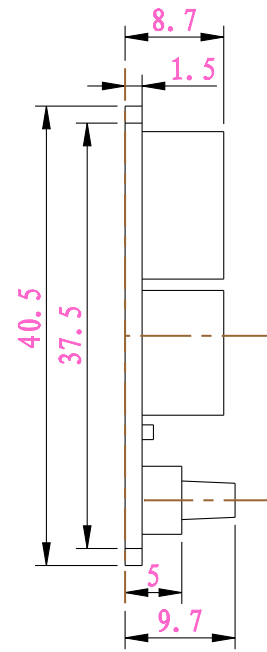
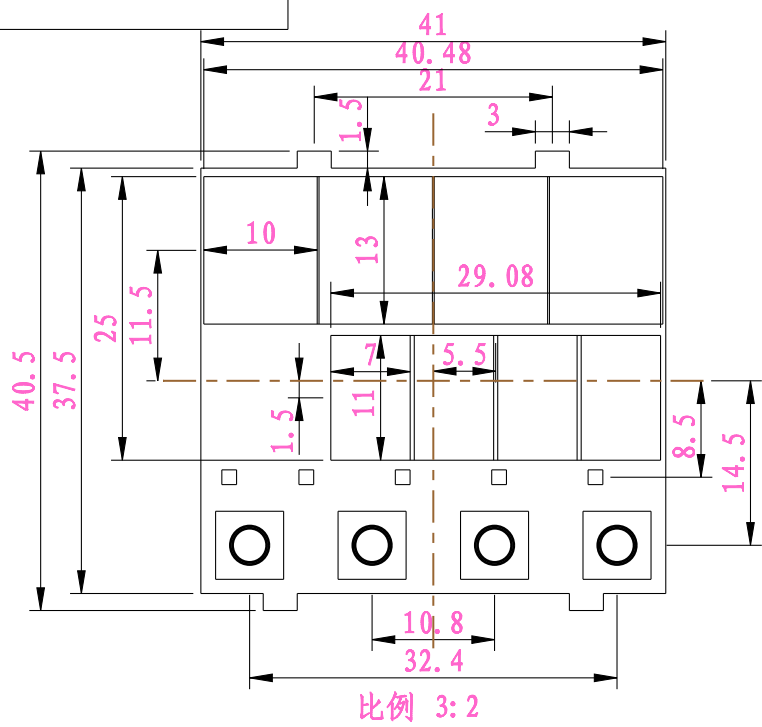

制图 Drawing	审核 Auditing	批准 Confirm	客户名称 Custom Name	本厂开发	材料 Material	
胡鑫波			产品名称 Product Name	线路板	图纸比例 Drawing Scale	3:2 A3
11-07-02			产品编号 Product Code	4874-XLB	视图 Project View	(mm)
共 1 页 第 1 页			宁波三和壳体公司 NINGBO SANHE ENCLOSURE CORPORATION		中国宁波慈溪 TEL: +86(574)63226910 FAX: +86(574)63226900	