

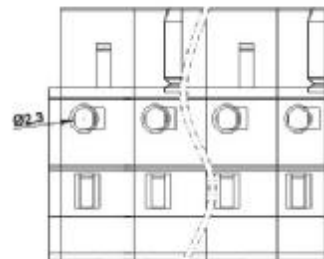

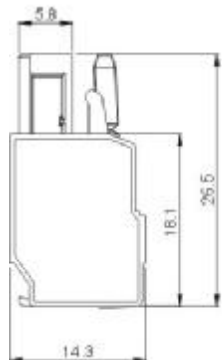

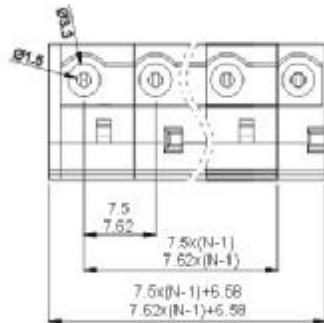

8EDGK-7.5
8EDGK-7.62

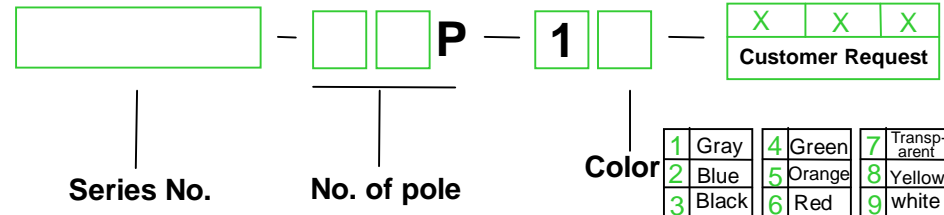

Approval	 	
Electrical		
Standard	UL	IEC
Rated voltage	300V	400V
Rated current	15A	20A
Wire range	22-14AWG	0.2-2.5mm ²
With standing voltage	AC2500V/1Min	
Mechanical		
Ambient temperature	-40℃~+105℃	
Strip length	8mm	
Dimensions		
Pitch	7.5mm(.295") 7.62mm(.300")	
Poles	2P-12P	
Material		
Housing	PA66,UL94V-0	
Contact	Phosphor bronze	
Wire guard	Stainless steel	

HOW TO ORDER :

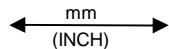

 mm (INCH)	 DEGSON ELECTRONICS CO., LTD.
 THROANGLE PROJECTION	NAME 8EDGK-7.5, 8EDGK-7.62