

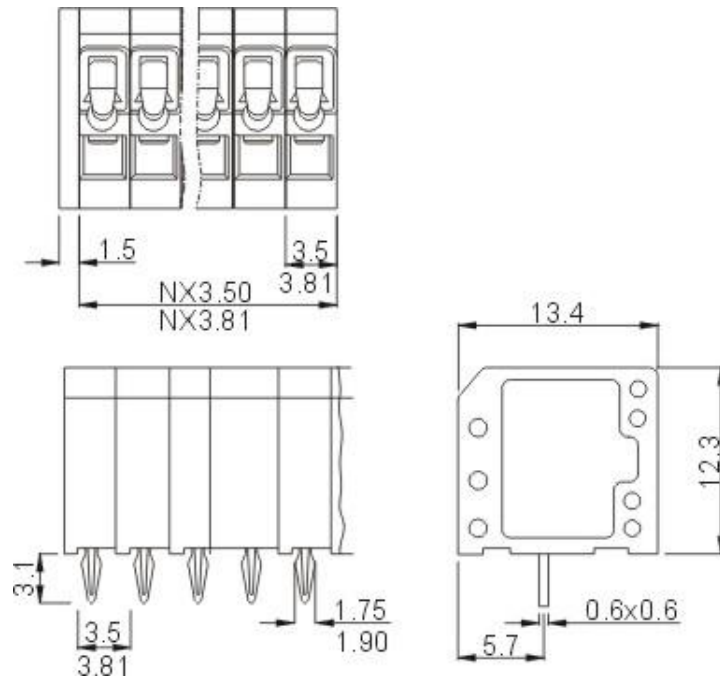

DEGSON ELECTRONICS CO., LTD.

Product Specification

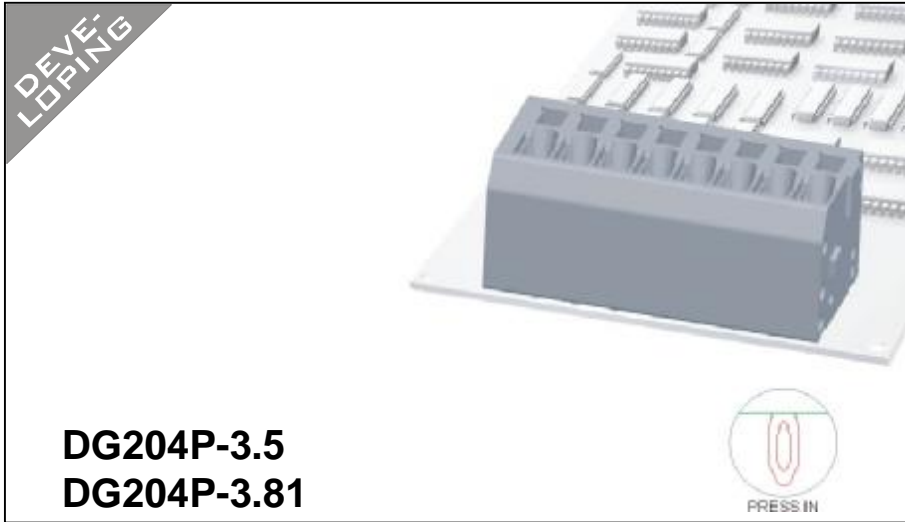

Approval		
Electrical		
Standard	UL	IEC
Rated voltage	300V	250V
Rated current	4A	4A
Wire range	28-14AWG	1.5mm ²
Withstanding voltage	AC2000V/1Min	
Mechanical		
Ambient temperature	-40°C~+105 °C	
Strip length	5-6mm	
Dimensions		
Pitch	3.5mm(.138")3.81 (.150")	
Poles	1P-XXP	
Material		
Housing	PA66,UL94V-0	
Pin header	Phosphor bronze,Tin plated	
Wire guard	Stainless steel	

HOW TO ORDER :

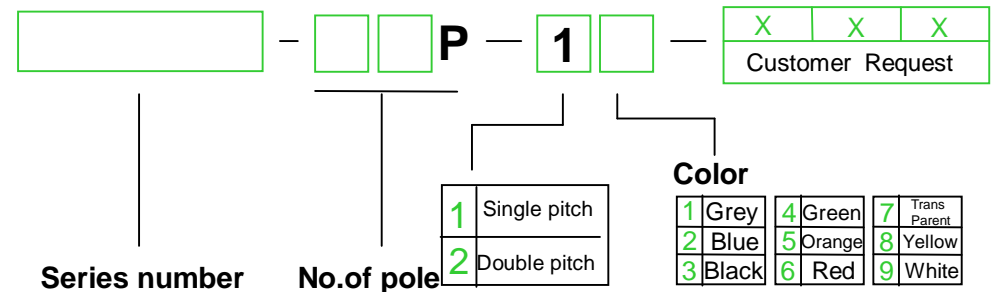

mm (INCH)	DEGSON ELECTRONICS CO., LTD.
THROANGLE PROJECTION	NAME DG204P-3.5, DG204P-3.81