

# ST 8050U

## NPN Silicon Epitaxial Planar Transistor

for switching and amplifier applications.  
Especially suitable for AF-driver stages  
and low power output stages.

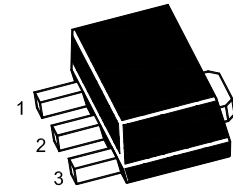

1.Base 2.Collector 3.Emitter  
SOT-89 Plastic Package

### Absolute Maximum Ratings ( $T_a = 25\text{ }^\circ\text{C}$ )

Parameter	Symbol	Value	Unit
Collector Base Voltage	$V_{CBO}$	40	V
Collector Emitter Voltage	$V_{CEO}$	25	V
Emitter Base Voltage	$V_{EBO}$	6	V
Collector Current	$I_C$	1.5	A
Power Dissipation	$P_{tot}$	625	mW
Junction Temperature	$T_j$	150	$^\circ\text{C}$
Storage Temperature Range	$T_{Stg}$	- 55 to + 150	$^\circ\text{C}$

### Characteristics at $T_a = 25\text{ }^\circ\text{C}$

Parameter	Symbol	Min.	Typ.	Max.	Unit
DC Current Gain at $V_{CE} = 1\text{ V}$ , $I_C = 5\text{ mA}$ at $V_{CE} = 1\text{ V}$ , $I_C = 100\text{ mA}$ at $V_{CE} = 1\text{ V}$ , $I_C = 800\text{ mA}$ Current Gain Group C D	$h_{FE}$	45	-	-	-
	$h_{FE}$	120	-	200	-
	$h_{FE}$	160	-	300	-
	$h_{FE}$	40	-	-	-
Collector Base Cutoff Current at $V_{CB} = 35\text{ V}$	$I_{CBO}$	-	-	100	nA
Emitter Base Cutoff Current at $V_{EB} = 6\text{ V}$	$I_{EBO}$	-	-	100	nA
Collector Base Breakdown Voltage at $I_C = 100\text{ }\mu\text{A}$	$V_{(BR)CBO}$	40	-	-	V
Collector Emitter Breakdown Voltage at $I_C = 2\text{ mA}$	$V_{(BR)CEO}$	25	-	-	V
Emitter Base Breakdown Voltage at $I_E = 100\text{ }\mu\text{A}$	$V_{(BR)EBO}$	6	-	-	V
Collector Emitter Saturation Voltage at $I_C = 800\text{ mA}$ , $I_B = 80\text{ mA}$	$V_{CE(sat)}$	-	-	0.5	V
Base Emitter Saturation Voltage at $I_C = 800\text{ mA}$ , $I_B = 80\text{ mA}$	$V_{BE(sat)}$	-	-	1.2	V
Base Emitter Voltage at $I_C = 10\text{ mA}$ , $V_{CE} = 1\text{ V}$	$V_{BE}$	-	-	1	V
Gain Bandwidth Product at $V_{CE} = 10\text{ V}$ , $I_C = 50\text{ mA}$	$f_T$	100	-	-	MHz
Collector Base Capacitance at $V_{CB} = 10\text{ V}$ , $f = 1\text{ MHz}$	$C_{OB}$	-	9	-	pF

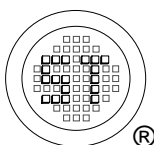

**SEMTECH ELECTRONICS LTD.**  
Subsidiary of Sino-Tech International (BVI) Limited



Dated : 19/09/2008

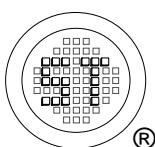
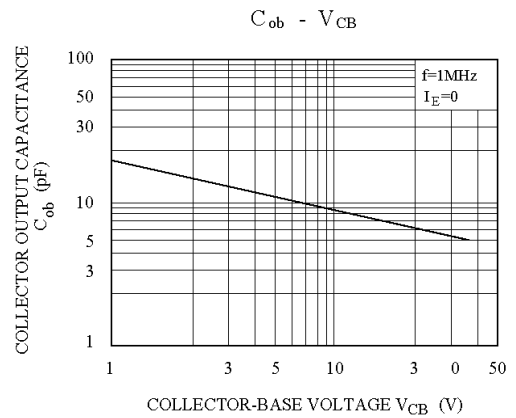
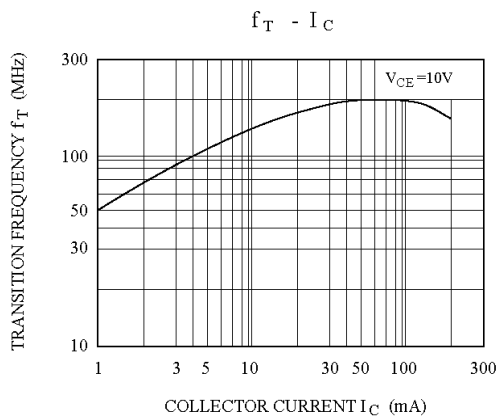
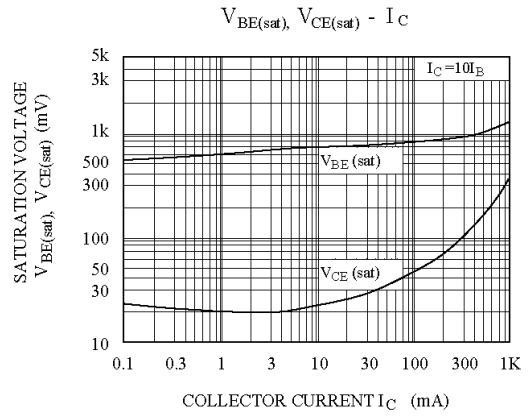
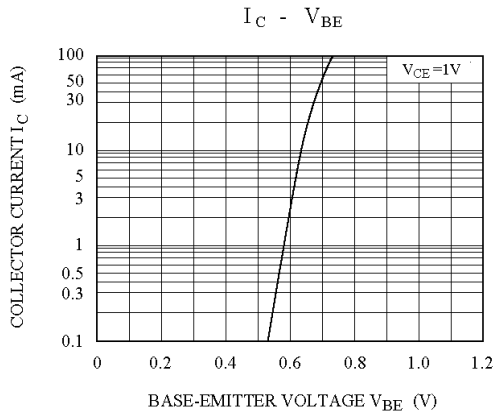
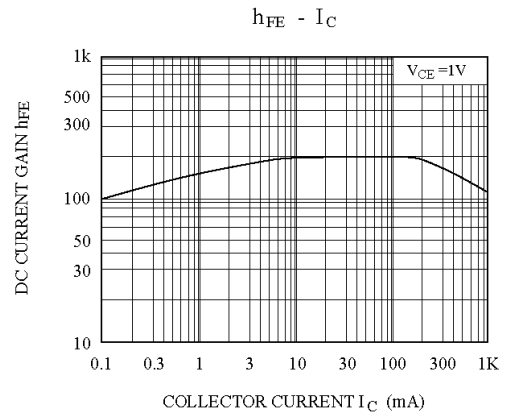
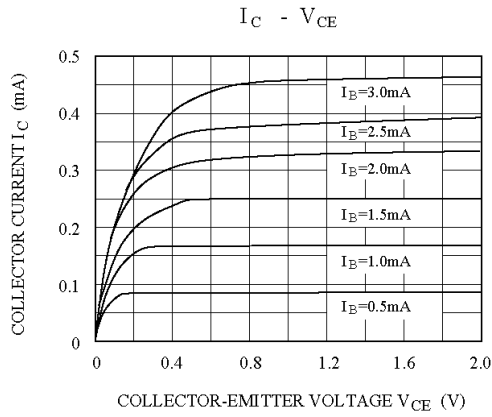

**SEMTECH ELECTRONICS LTD.**  
 Subsidiary of Sino-Tech International (BVI) Limited



# ST 8050U

## SOT-89 PACKAGE OUTLINE

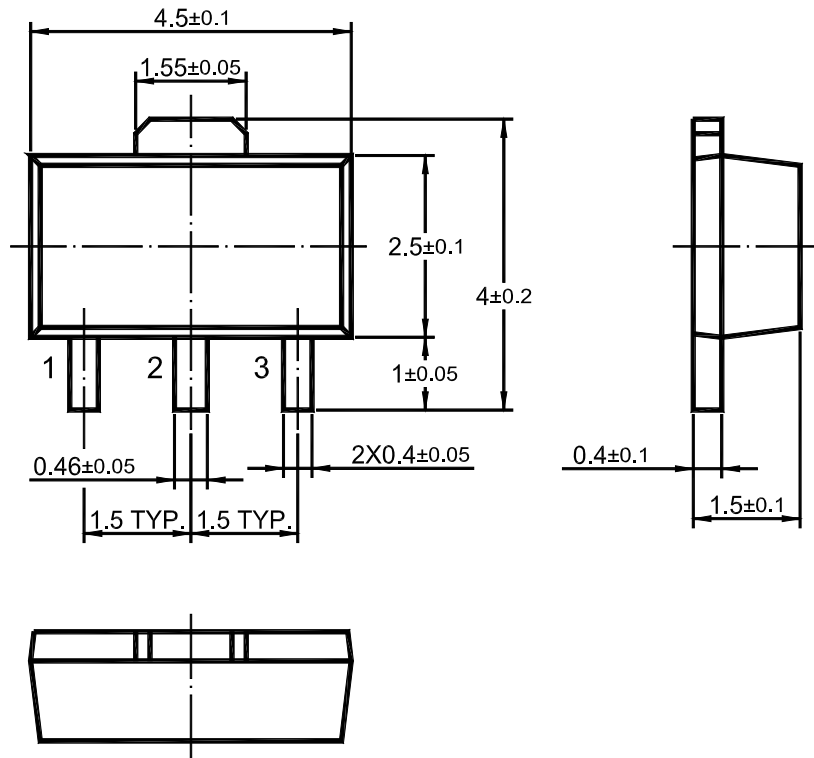

Dimensions in mm

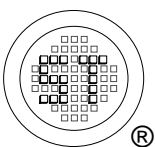

**SEMTECH ELECTRONICS LTD.**  
Subsidiary of Sino-Tech International (BVI) Limited



Dated : 19/09/2008