

ST 2SD2391U

NPN Silicon Epitaxial Planar Transistor

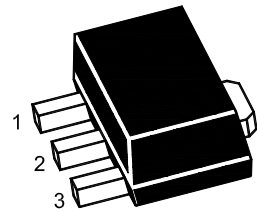

1.Base 2.Collector 3.Emitter
SOT-89 Plastic Package

Absolute Maximum Ratings ($T_a = 25\text{ }^\circ\text{C}$)

Parameter	Symbol	Value	Unit
Collector Base Voltage	V_{CBO}	60	V
Collector Emitter Voltage	V_{CEO}	60	V
Emitter Base Voltage	V_{EBO}	6	V
Collector Current	I_C	2	A
Peak Collector Current ($P_W = 10\text{ ms}$)	I_{CP}	6	A
Total Power Dissipation	P_{tot}	0.5 2 ¹⁾	W
Junction Temperature	T_j	150	$^\circ\text{C}$
Storage Temperature Range	T_{stg}	- 55 to + 150	$^\circ\text{C}$

¹⁾ When mounted on a 40 x 40 x 0.7 mm ceramic board.

Characteristics at $T_a = 25\text{ }^\circ\text{C}$

Parameter	Symbol	Min.	Typ.	Max.	Unit
DC Current Gain at $V_{CE} = 2\text{ V}$, $I_C = 500\text{ mA}$ at $V_{CE} = 2\text{ V}$, $I_C = 1.5\text{ A}$	h_{FE} h_{FE}	120 45	- -	270 -	- -
Collector Base Cutoff Current at $V_{CB} = 50\text{ V}$	I_{CBO}	-	-	100	nA
Emitter Base Cutoff Current at $V_{EB} = 5\text{ V}$	I_{EBO}	-	-	100	nA
Collector Base Breakdown Voltage at $I_C = 50\text{ }\mu\text{A}$	$V_{(BR)CBO}$	60	-	-	V
Collector Emitter Breakdown Voltage at $I_C = 1\text{ mA}$	$V_{(BR)CEO}$	60	-	-	V
Emitter Base Breakdown Voltage at $I_E = 50\text{ }\mu\text{A}$	$V_{(BR)EBO}$	6	-	-	V
Collector Emitter Saturation Voltage at $I_C = 1\text{ A}$, $I_B = 50\text{ mA}$	$V_{CE(sat)}$	-	-	0.35	V
Transition Frequency at $V_{CE} = 2\text{ V}$, $-I_E = 500\text{ mA}$, $f = 100\text{ MHz}$	f_T	-	120	-	MHz
Collector Output Capacitance at $V_{CB} = 10\text{ V}$, $f = 1\text{ MHz}$	C_{ob}	-	21	-	pF

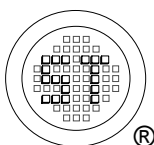

SEMTECH ELECTRONICS LTD.
Subsidiary of Sino-Tech International (BVI) Limited



Dated: 24/03/2012 Rev: 01

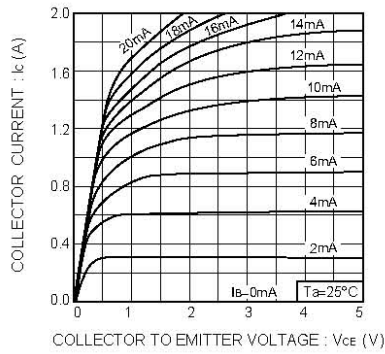

Fig.1 Grounded emitter output characteristics

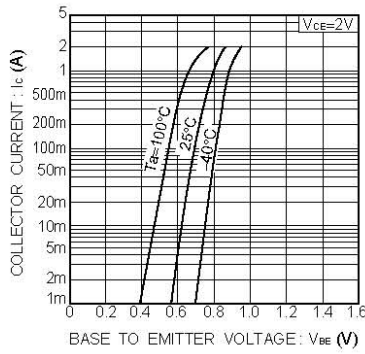

Fig.2 Grounded emitter propagation characteristics

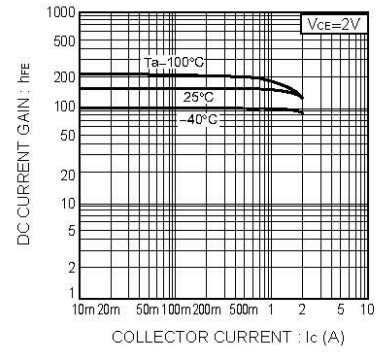

Fig.3 DC current gain vs. collector current (I)

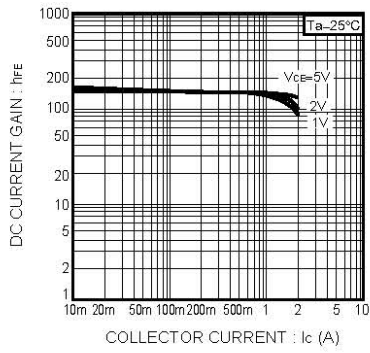

Fig.4 DC current gain vs. collector current (II)

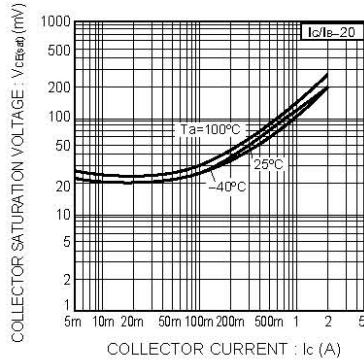

Fig.5 Collector-emitter saturation voltage vs. collector current (I)

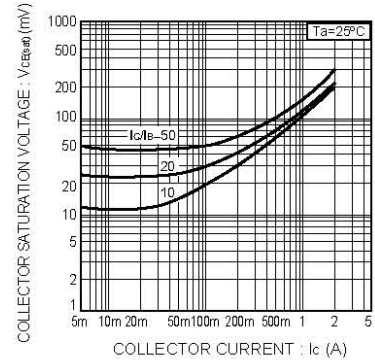
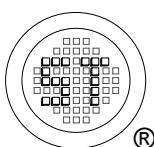

Fig.6 Collector-emitter saturation voltage vs. collector current (II)



SEMTECH ELECTRONICS LTD.
Subsidiary of Sino-Tech International (BVI) Limited



ST 2SD2391U

SOT-89 PACKAGE OUTLINE

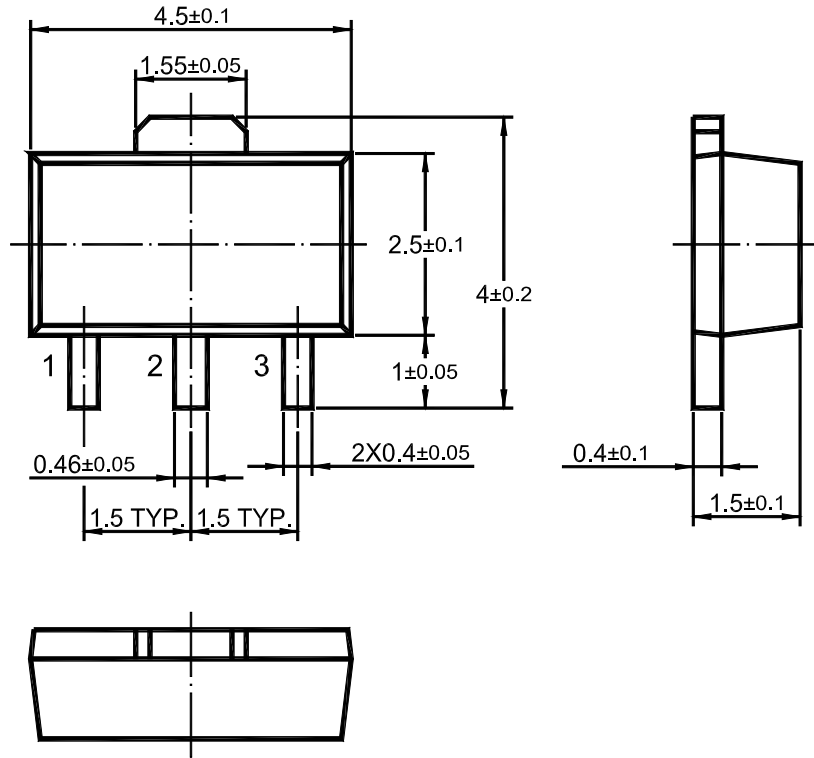

Dimensions in mm

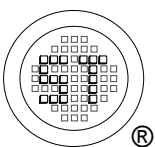

SEMTECH ELECTRONICS LTD.
Subsidiary of Sino-Tech International (BVI) Limited



Dated: 24/03/2012 Rev: 01