

Product Appearance

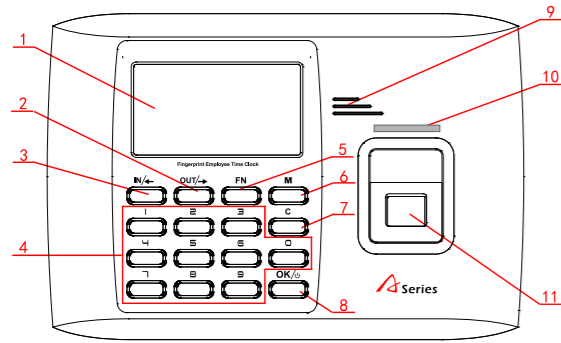

- 1.LCD
- 2.State Key(Clock Out) Page Down
- 3.State Key(Clock In) Page Up
- 4.0-9 Num. Key
- 5.FN key
- 6.Menu Key
- 7.Delete/Exit key
- 8.Confirm/Power Key
- 9.Loudspeaker
- 10.LED
- 11.Fingerprint Sensor

Menu List

Press [OK] about 3 seconds to turn on the terminal, press [M] key to enter the management menu. Menu list:

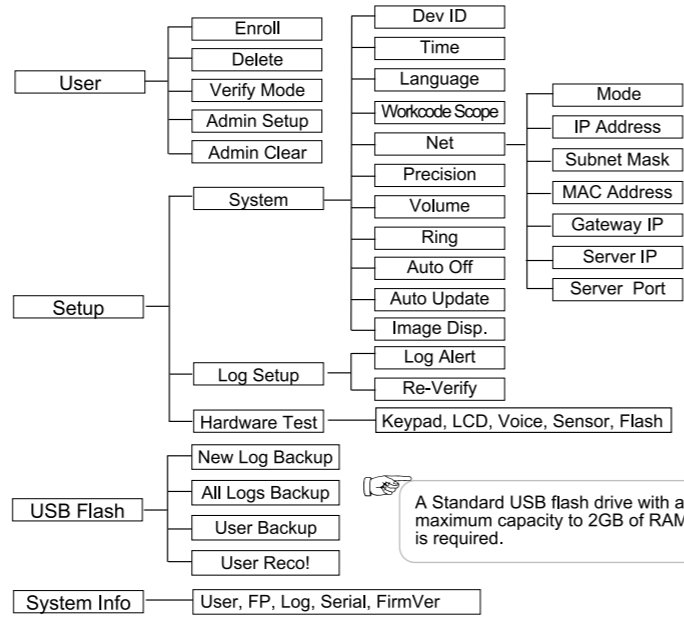

A Standard USB flash drive with a maximum capacity to 2GB of RAM is required.

Other Setup

Verify Mode: M→[User]→[OK]→[Verify Mode]→[OK]→[OK]→Input employee ID→[OK]→Use [IN/-]/[OUT/-] to select ANY/RF+FP/PW+FP/RF+PW/ID+FP→[OK]→[OK].

Item	Explanation
Any	Fingerprint only, Card only or ID+Password only
★ RF+FP	It requires both Card and Fingerprint verification together
★ PW+FP	It requires both Password and Fingerprint verification together
RF+PW	It requires both Card and Password verification together
ID+FP	Enter the user ID first, then verify the fingerprint
Factory default setting	Any

Dev ID: M→[Setup]→[OK]→[System]→[OK]→[Dev ID]→[OK]→Input the device's ID→[OK]→[C]→[OK].

Item	Explanation
1-9999999	Device ID of the unit which is required in software communication
Factory default setting	1

Language: M→[Setup]→[OK]→[System]→[OK]→[Language]→[OK]→Use [IN/-]/[OUT/-] to select ENG/FRCH/GERM/...→[OK]→[C]→[OK].

Item	Explanation
Language	Contains 11 languages: ENG(English), FRCH(French), GERM(German), SPAN(Spanish), PTG(Portuguese), ITA(Italian), BULG(Bulgarian), SLVK(Slovak), HUNG(Hungarian), SLVN(Slovenian), TURK(Turkish)
Factory default setting	Related Language

WorkCode: M→[Setup]→[OK]→[System]→[OK]→[WorkCode Scope]→[OK]→Input Max→[OK]→Input Min→[OK]→[C]→[OK].

Item	Explanation
0-999999	Valid scope for the Workcode
Factory default setting	Max 999999 Min 0

Tips: WorkCode indicates the work type, easily distinguishes which attendance record is related to which work type.

Ring: Use the function in the software.

Item	Explanation
1-15	The duration of the audible alarm to notify employees of events. (Lunch, break, Off Duty)
No	Electric bell under closed state
Factory default setting	5

★ Net: M→[Setup]→[OK]→[System]→[OK]→[Net]→[OK]→to select [Mode/IP Address/Subnet Mask /MAC Address/Gateway IP/Server IP/Server Port]→[OK]→Modify parameters→[C]→[OK].

Item	Explanation	Factory default setting
Mode	TCP/IP Server mode: Common network mode TCP/IP Client mode: Only communicate with the PC which has static IP	Server Mode
IP Address	Set terminal IP address when communication of TCP/IP, IP address must be a static IP address	192.168.0.218
Subnet Mask	Subnet Mask of the LAN	255.255.255.0
MAC Address	Unique Physical address of the network module. This setting can not be modified.	
Gateway IP	Default Gateway of the LAN	192.168.0.1
Server IP	The IP address of the Sever Machine when using Client Mode TCP/IP communication.	192.168.0.7
Server Port	It's the Software Port number used when the read is configured for TCP/IP communication	5010

Precision, Volume, Auto off, Auto Update, Image Disp., Log Alert, Re-Verify

Item	Explanation
Precision	Set terminal fingerprint matching precision. 0-[Normal], 1-[Good], 2-[Exact].
Volume	Set the terminal voice volume. 0-[mute], 5-[Max].
Auto off	Set the time duration for an idle clock to go into sleep mode. No-[Not Off], 250min-[Max Time].
Auto Update	Auto update means the previous lower quality fingerprint template will be automatically replaced by the new higher quality one during fingerprint verification.
Image Disp.	Choose to display the fingerprint image on the screen during the verification process. [Yes] - show fingerprint image, [No] - not show fingerprint image
Log Alert	The terminal will alarm when the memory capacity is less than the [Log Alert] value.[No]-Not alarm, Max. value 5,000.
Re-Verify	The duration of time in which the terminal will ignore repeated attempts for authentication. [No]: Disable the function; Max. value is 250 min.

Illustration for placing finger

Correct method :

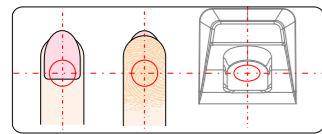

Place finger in the center of the sensor.

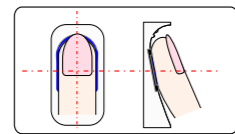

Place finger flat on the sensor surface.

Incorrect method :

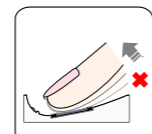

Do not remove finger during the enrollment process.

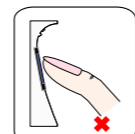

Using the tip of your finger.

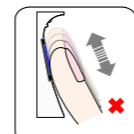

Sliding, Rolling or Moving finger during the enrollment process.

Operation Guide

- Enroll User: Each user can register two fingerprints, one password and one RFID card. (Functions marked with a Star are for specific models that include these features.)

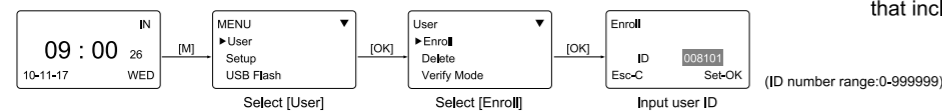

- Enroll Fingerprint: Place finger on the sensor twice to enroll fingerprints.

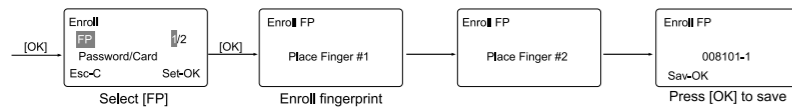

- Enroll Password: Password length: 0-999999.

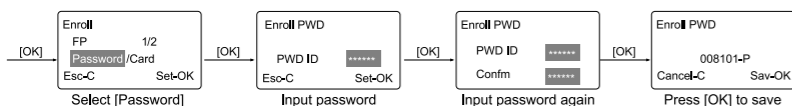

- Enroll Card★:

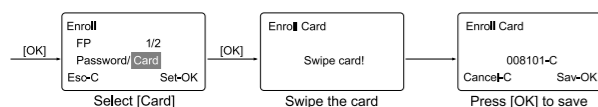

- Admin Setup: Admin(Administrator) has all the privileges of the machine. Please pay attention to the admin setup.

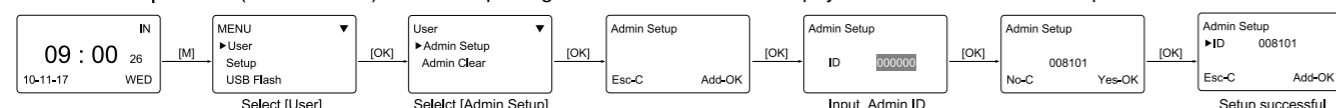

Wiring Diagram

