

REV.	DESCRIPTION	DRAWN	DATE
1	INITIAL RELEASE	TIM	2019/01/21

SPECIFICATION:

- 1.1 Current Rating: 1.5A
- 1.2 Voltage Rating: 125V AC/DC
- 1.3 Water Proof: IPX7
- 1.4 Operation Temperature: -40°C to +85°C

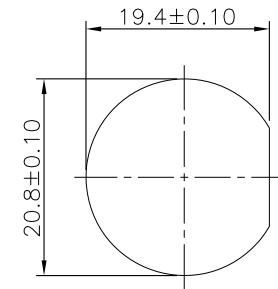
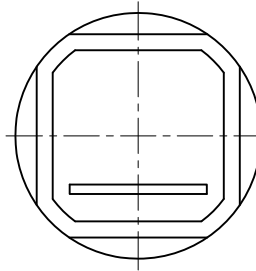
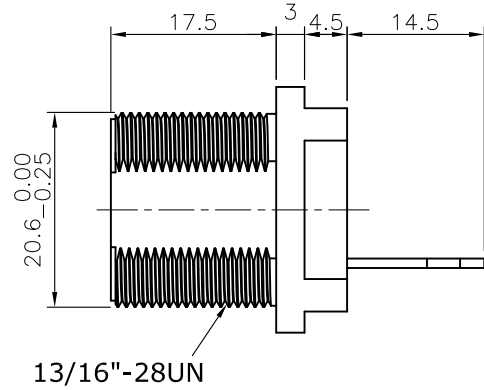
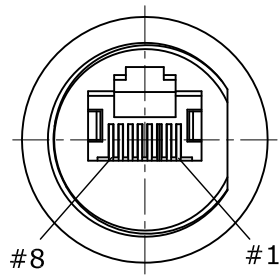

Recommended Panel Cut Out

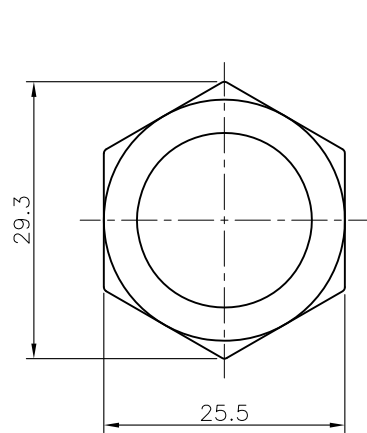

Nut

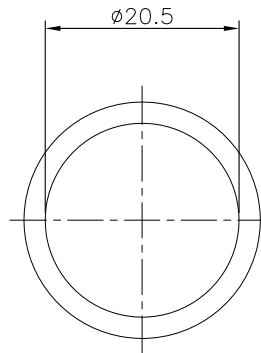
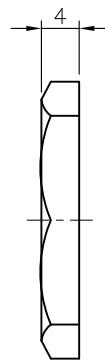

Gasket

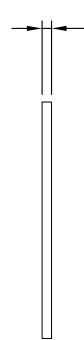

6	NUT	PA66
5	GASKET	Silicone, Gray Black
4	GROUND	Stainless Steel, Nickel plating
3	SHELL	PA66, UL94V-0, Black
2	CONTACT	Phosphor Bronze, Gold plating over Nickel
1	HOUSING	PBT, UL94V-0, Black

NO.	PART NAME	DESCRIPTION					
UNLESS OTHERWISE SPECIFIED TOLERANCE							
UNIT:	DECIMAL	LINEAR	ANGLES				
mm	X.	±0.50	±5°				
	X.X	±0.25	±3°				
	X.XX	±0.12	±1°				
WWW.ATTEND.COM.TW							
DRAWN	Tim	2019/01/21	DRAWN NAME:				
CHECKED	Fros	2019/01/21	RJ45 8P8C Waterproof Socket With PCB				
APPROVED	Ken	2019/01/21	PRODUCT NO.				
SCALE	1.25	SHEET	1/1	SIZE	A4	FILE NAME	222A-03002_B_1

