

REV.	DESCRIPTION	DRAWN	DATE
1	INITIAL RELEASE	FROS	2022/07/18

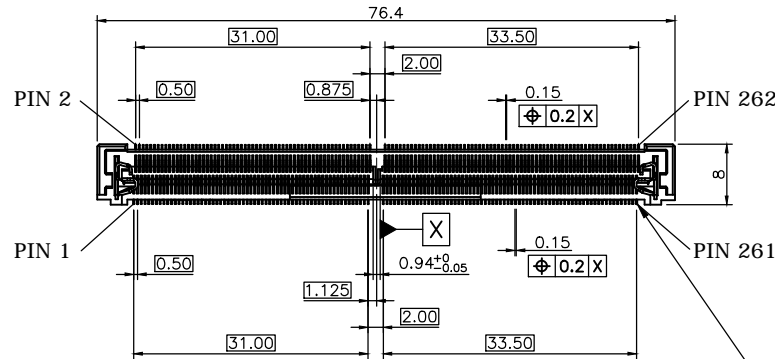

**SPECIFICATION:**

**1. ELECTRICAL**

- 1.1 Current Rating: 0.6A per pin
- 1.2 Voltage Rating: 25V AC
- 1.3 Contact Resistance: 60mΩ max.
- 1.4 Insulation Resistance: 100MΩ
- 1.5 Dielectric Withstanding Voltage: 500VAC

2.3 Extraction Force: 44.6N max.

**3. ENVIRONMENTAL**

- 3.1 Operating temperature range: -55°C~+85°C
- 3.2 Storage temperature range: -55°C~+85°C

**2. MECHANICAL**

- 2.1 Durability: 50 Cycle
- 2.2 Insertion Force: 59.8N max.

**4. SOLDER ABILITY**

- 4.1 Recommended IR-Reflow Temperature: 260°C

DATE CODE: YWWD

Y: YEAR  
 WW: WEEK (01~52)  
 D: DAY (1~7)

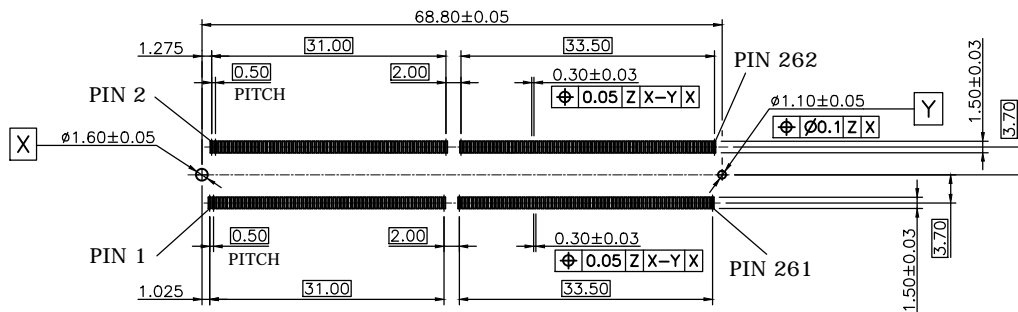
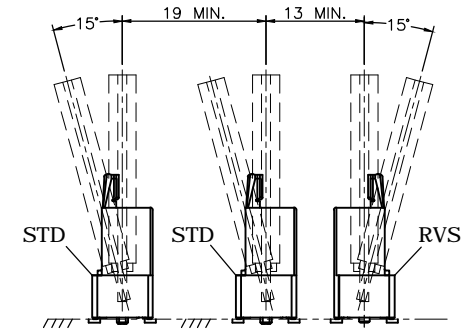
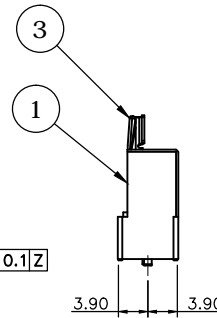
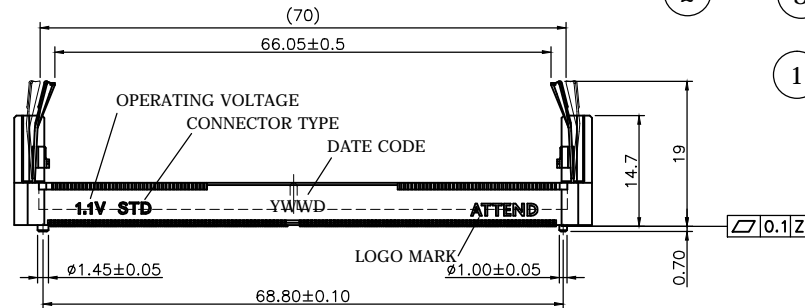

**RECOMMENDED SOCKET MOUNTING LAYOUT**

3	LATCH	STAINLESS STEEL		
2	CONTACT	PHOSPHOR BRONZE, GOLD FLASH		
1	HOUSING	LCP, UL94V-0, BLACK		
NO.	PART NAME	DESCRIPTION		
UNLESS OTHERWISE SPECIFIED TOLERANCE				
UNIT:	DECIMAL	LINEAR	ANGLES	
mm	X.	±0.50	±5°	
	X.X	±0.25	±3°	
	X.XX	±0.12	±1°	
www.attend.com.tw				
DRAWN	Fros	2021/12/03	DRAWN NAME:	
CHECKED	Tim	2021/12/03	DDR5 SODIMM Socket, Vertical 19H, STD, G/F, Black, Tray	
APPROVED	Ken	2021/12/03	PRODUCT NO. 126B-190A00	
SCALE	1/1	SHEET 1/1	SIZE A4	FILE NAME 126B-190A00_B_1

**RECOMMENDED PCB LAYOUT (TOP VIEW)**  
 GENERAL TOLERANCE: ±0.05mm

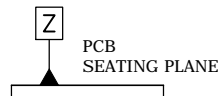

REV.	DESCRIPTION	DRAWN	DATE
1	INITIAL RELEASE	FROS	2021/03/23

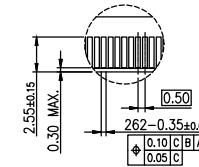
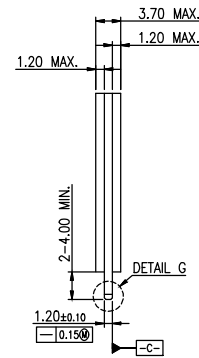
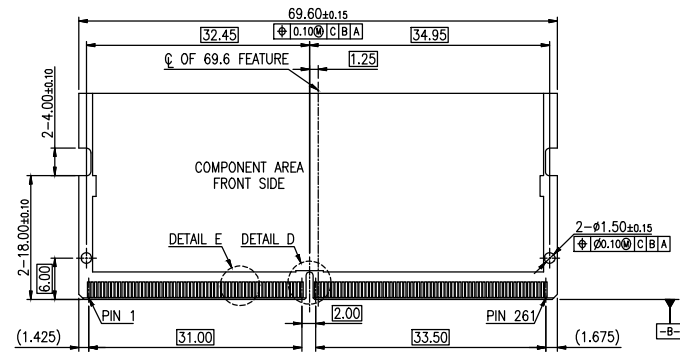

DETAIL E  
SCALE 2:1

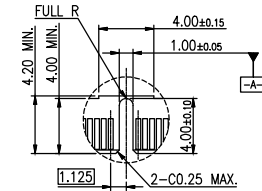

DETAIL D  
SCALE 2:1

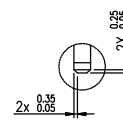
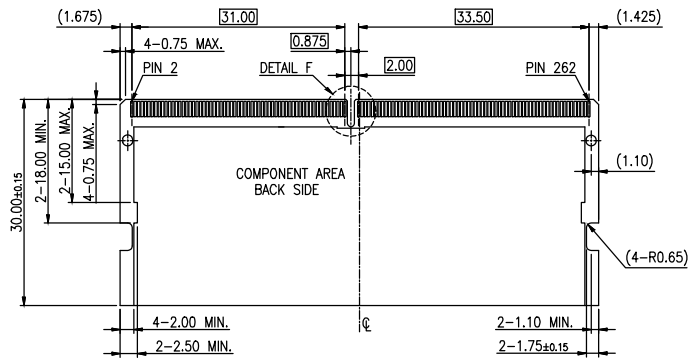

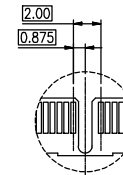

DETAIL G  
SCALE 2:1



DETAIL F  
SCALE 2:1

RECOMMEND MODULE CONFIGURATION

UNLESS OTHERWISE SPECIFIED TOLERANCE					
UNIT:	DECIMAL	LINEAR	ANGLES		
mm	X.	±0.50	±5°	www.attend.com.tw	
	X.X	±0.25	±3°		
	X.XX	±0.12	±1°		
DRAWN	Fros	2021/03/23	DRAWN NAME:		
CHECKED	Tim	2021/03/23	262 PIN DDR5 SODIMM, 0.5MM PITCH PACKAGE		
APPROVED	Ken	2021/03/23	PRODUCT NO.		
	SCALE 1.25	SHEET 1/1	SIZE A4	FILE NAME	126A-CARD_B_1

REV.	DESCRIPTION	DRAWN	DATE
1	Initial Release	TIM	2023/01/09

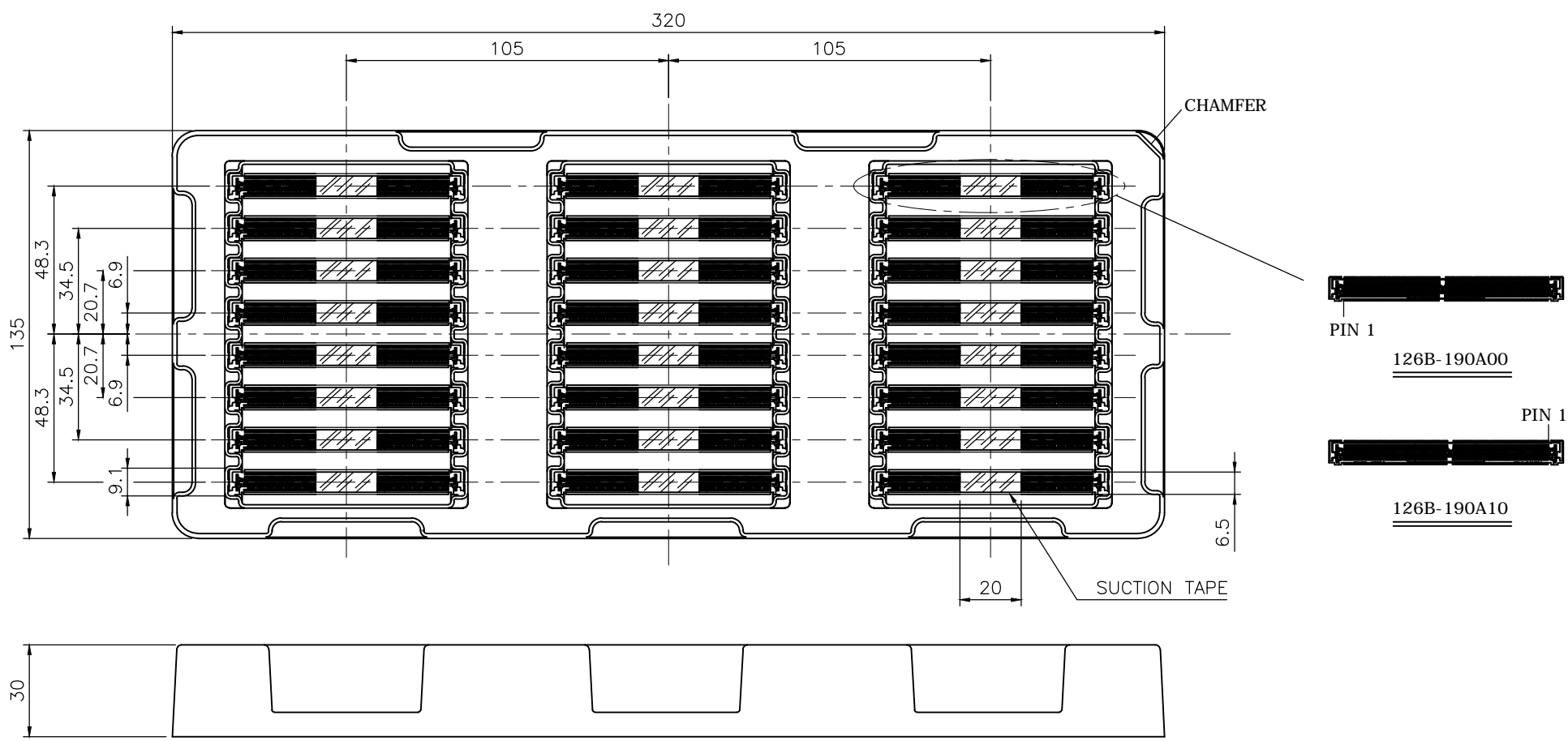

P/N	QTY/TRAY	INNER BOX	CARTON
126B-190A00	24	192	576
126B-190A10	24	192	576

UNLESS OTHERWISE SPECIFIED TOLERANCE				 <a href="http://WWW.ATTEND.COM.TW">WWW.ATTEND.COM.TW</a>
UNIT:	DECIMAL	LINEAR	ANGLES	
mm	X.	±0.50	±5°	
	X.X	±0.25	±3°	
	X.XX	±0.12	±1°	
DRAWN	Tim	2022/10/11	DRAWN NAME:	
CHECKED	Fros	2022/10/11	DDR5 SODIMM Socket, Vertical PACKAGING	
APPROVED	Ken	2022/10/11	PRODUCT NO. SEE TABLE	
SCALE	1/2	SHEET	1/1	FILE NAME
		SIZE	A4	126B-190AX0_D_1