

BOM LIST			
ITEM	PART NAME	Q'ty	NOTES
1	PLASTIC HOOD	2	SEE P/N
2	2.1 LONG BOLT	2	#4-40
	2.2 SHORT BOLT	2	#4-40
3	NUT	2	M3
4	LONG SCREW	2	M3
5	SMALL WASHER	2	M3
6	SHORT SCREW	2	M3
7	METAL WASHER	2	M3

REV.	DESCRIPTION	DRAWN	CHECKED	APPROVED
A	NEW RELEASE	LJH 08/13/05'	~	LJC 08/13/05'
C	整理英制短螺丝尺寸	YCH 07/18/08'	~	LJC 07/18/08'
D	增加“全包装”类型	YCH 05/20/10'	~	LJC 05/20/10'
E	改M3*12的螺钉为M3*10	YCH 08/30/10'	~	LJC 08/30/10'
F	ADD P/N CODE	LJC 12/24/13'	~	LJC 12/24/13'
L	DRAWING UPDATE	JLZ 05/21/18'	~	

NOTES:

1. Hardwares are all Nickel plated.

2. PART NUMBER CODE:

DS1045 - 09 X X X X X - X

Hood Materials (H)

A: ABS
B: Similar ABS

Washer type
1: Metal

Bolt type
L: Long
S: Short

Packing type
1: Mix packing
Q: Full packing

Cover Material
P: Plastic(ABS)
Cover Color
A: Gray
B: Black
V: Ivory
Position
09: 9pin

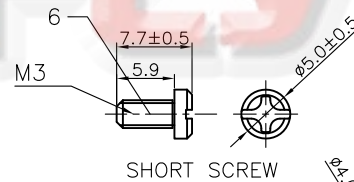
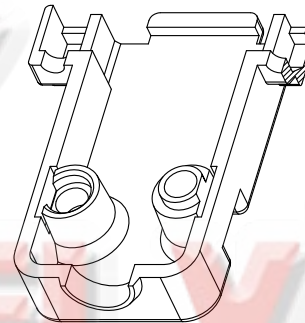
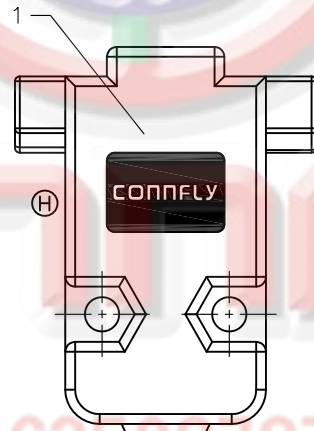
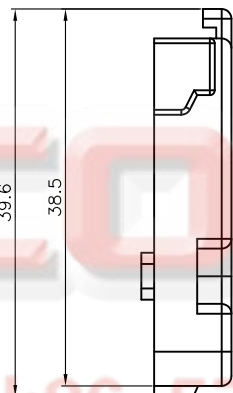
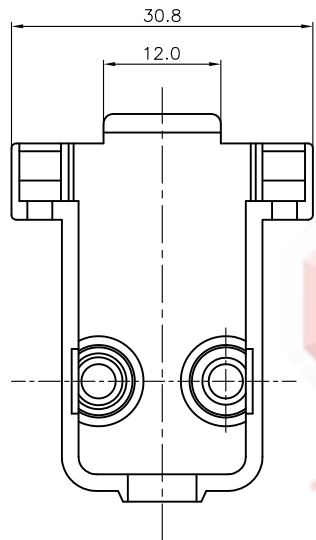
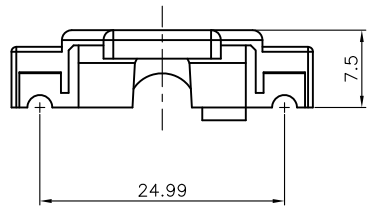

SHORT SCREW

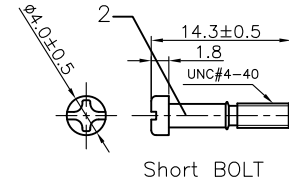

Short BOLT

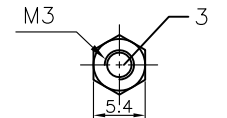

NUT t=2.3mm

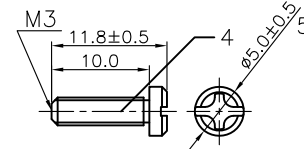

LONG SCREW

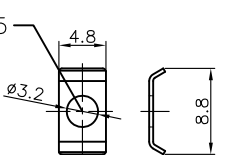

SMALL WASHER

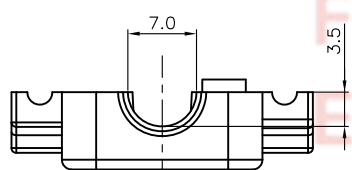

4-40 UNC

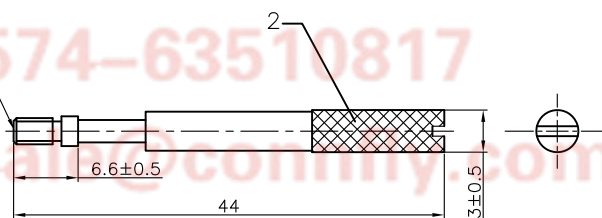

Long BOLT

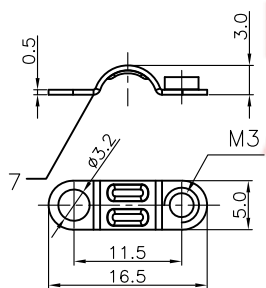

Metal

GENERAL TOLERANCE		ANGLE TOLERANCE	
X.	±0.60	X.	±5°
.X	±0.38	.X	±3°
.XX	±0.25	.XX	±2°

DRAWING TYPE		COSTOMER	
SCALE	1:1	SHEET	1 OF 1
DRAWING NO.	C-DS1045-09XXXXX-X-L		

PROJECTION	TITLE	D-SUB Plastic Hood 180°y 9 Positions	
UNITS	mm	SHEET	DS1045 SERIES
SHEET SIZE	A4	SERIES	DS1045 SERIES



晨翔电子有限公司

CONNFLY® CONNFLY ELECTRONIC CO., LTD

Tel:86-574-63508787
Fax:86-574-63510817
E-mail:sales@connfly.com
http://www.connfly.com
Add:East Industry Zone Kuyuan
Town Civi ngao China
P.C:315333

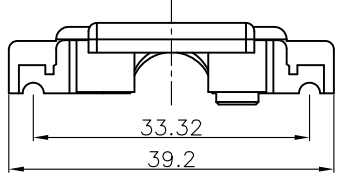

BOM LIST			
ITEM	PART NAME	Q'ty	NOTES
1	PLASTIC HOOD	2	SEE P/N
2	2.1 LONG BOLT	2	#4-40
	2.2 SHORT BOLT	2	#4-40
3	NUT	2	M3
4	LONG SCREW	2	M3
5	SMALL WASHER	2	
6	SHORT SCREW	2	M3
7	METAL WASHER	2	M3

REV.	DESCRIPTION	DRAWN	CHECKED	APPROVED
A	NEW RELEASE	LJH 05/18/05'	~	LJC 05/18/05'
C	整理英制短螺丝尺寸	YCH 07/18/08'	~	LJC 07/18/08'
D	增加“全包装”类型	YCH 05/20/10'	~	LJC 05/20/10'
E	ADD P/N CODE	LJC 12/24/13'	~	LJC 12/24/13'
K	DRAWING UPDATE	JLZ 05/21/18'	~	

NOTES:
 1. Hardwares are all Nickel plated.
 2. PART NUMBER CODE:
 DS1045 - 15 X X X X X - X

Hood Materials (E)
 A: ABS
 B: Similar ABS

Washer type
 1: Metal

Bolt type
 L: Long
 S: Short

Packing type
 1: Mix packing
 Q: Full packing

Cover Material
 P: Plastic(ABS)
 Cover Color
 A: Gray
 B: Black
 V: Ivory
 Position
 15: 15pin

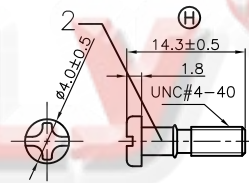
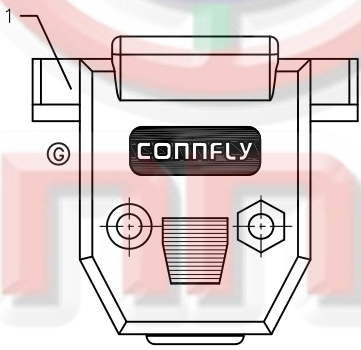
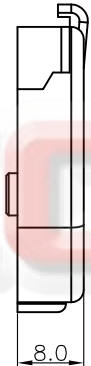
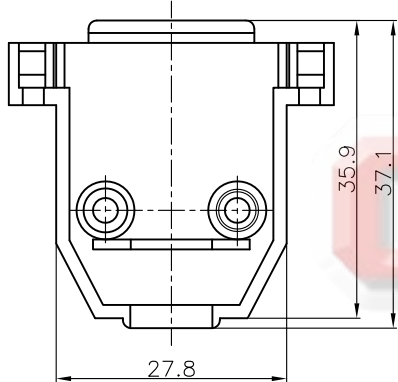
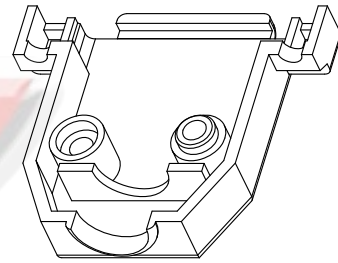

Short BOLT

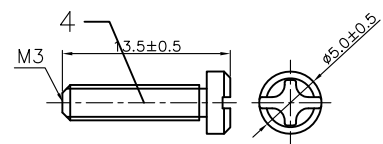

LONG SCREW

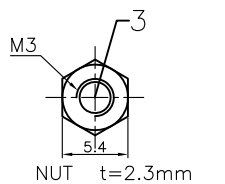

NUT t=2.3mm

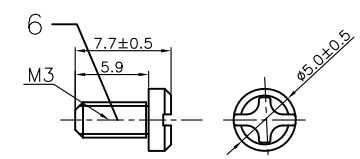

SHORT SCREW

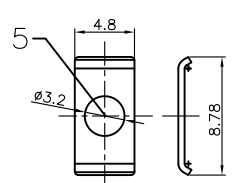

SMALL WASHER

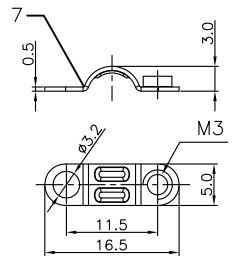
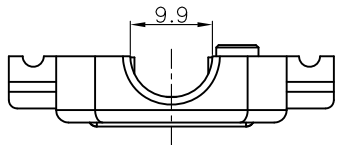

Metal

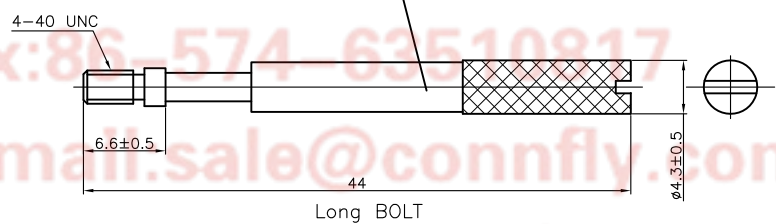

Long BOLT

Tel:86-574-63508787
 Fax:86-574-63510817
 E-mail:sale@connfly.com
 http://www.connfly.com
 Add:East Industry Zone, Kexing
 Town Cixiling, Ningbo
 P.C:315333

GENERAL TOLERANCE		ANGLE TOLERANCE	
X.	±0.60	X.	±5°
.X	±0.38	.X	±3°
.XX	±0.25	.XX	±2°

DRAWING TYPE	COSTOMER		
SCALE	1:1	SHEET	1 OF 1
DRAWING NO.	C-DS1045-15XXXXX-X-L		

PROJECTION	TITLE	D-SUB Plastic Hood 180°y 15 Positions	
UNITS	mm	SHEET SIZE	A4
SHEET SIZE	A4	SERIES	DS1045 SERIES

 晨翔电子有限公司
CONNFLY® CONNFLY ELECTRONIC CO., LTD

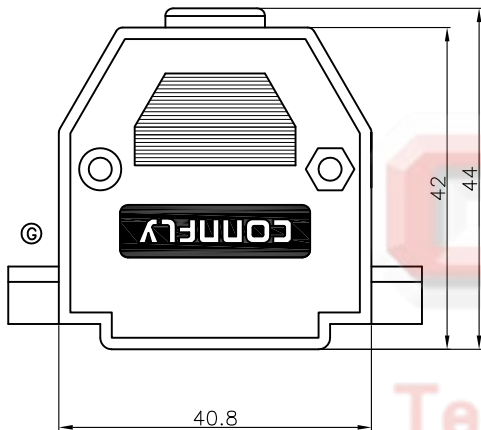
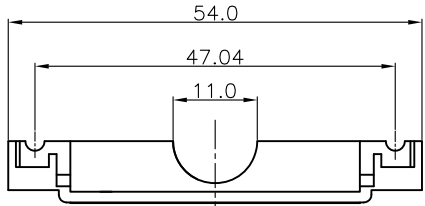

BOM LIST			
ITEM	PART NAME	Q'ty	NOTES
1	PLASTIC HOOD	2	SEE P/N
2	2.1 LONG BOLT	2	#4-40
	2.2 SHORT BOLT	2	#4-40
3	NUT	2	M3
4	LONG SCREW	2	M3
5	SMALL WASHER	2	
6	SHORT SCREW	2	M3
7	METAL WASHER	2	M3

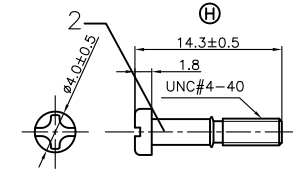
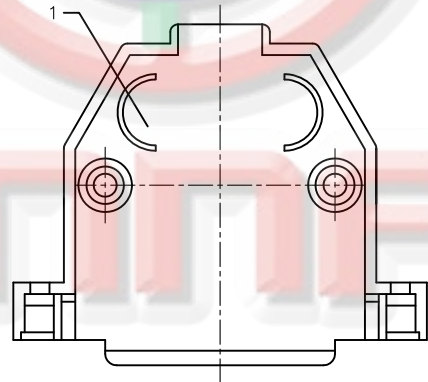
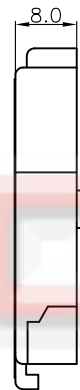

Short BOLT

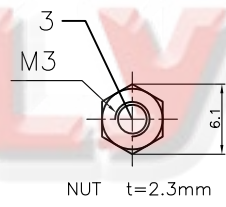

NUT t=2.3mm

NOTES:
 1. Hardwares are all Nickel plated.
 2. PART NUMBER CODE:
 DS1045 - 25 X X X X X - X

Hood Materials (E)
 A: ABS
 B: Similar ABS

Washer type
 1: Metal

Bolt type
 L: Long
 S: Short

Packing type
 1: Mix packing
 Q: Full packing

Cover Material
 P: Plastic(ABS)

Cover Color
 A: Gray
 B: Black
 V: Ivory

Position
 25: 25pin

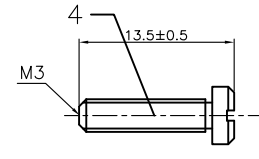

LONG SCREW

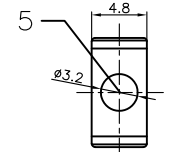

SMALL WASHER

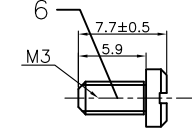

SHORT SCREW

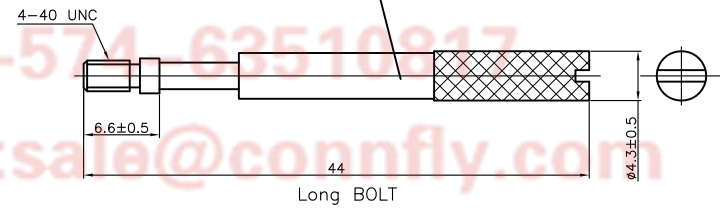
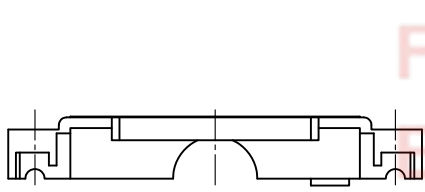

Long BOLT

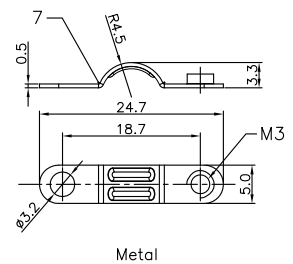

Metal

Tel:86-574-63508787
 Fax:86-574-63510817
 E-mail:sale@connfly.com
 http://www.connfly.com
 Add:East Industry Zone Kuanqian
 Town Cixilingbo China
 P.C:315333

GENERAL TOLERANCE		ANGLE TOLERANCE	
X.	±0.60	X.	±5°
.X	±0.38	.X	±3°
.XX	±0.25	.XX	±2°

PROJECTION	TITLE
	D-SUB Plastic Hood 180°y 25 Positions
UNITS	mm
SHEET SIZE	A4
SERIES	DS1045 SERIES

DRAWING TYPE	COSTOMER
SCALE	1:1
DRAWING NO.	C-DS1045-25XXXXX-X-L

晨翔电子有限公司
CONNFLY® CONNFLY ELECTRONIC CO., LTD

BOM LIST			
ITEM	PART NAME	Q'ty	NOTES
1	PLASTIC HOOD	2	SEE P/N
2	LONG BOLT	2	#4-40
	SHORT BOLT	2	#4-40
3	NUT	2	M3
4	LONG SCREW	2	M3
5	SMALL WASHER	2	M3
6	SHORT SCREW	2	M3
7	METAL WASHER	2	M3

REV.	DESCRIPTION	DRAWN	CHECKED	APPROVED
A	NEW RELEASE	LJH 10/26/05'	~	LJC 10/26/05'
C	整理英制短螺丝尺寸	YCH 07/18/08'	~	LJC 07/18/08'
D	增加“全包装”类型	YCH 05/20/10'	~	LJC 05/20/10'
E	ADD P/N CODE	LJC 12/24/13'	~	LJC 12/24/13'
L	DRAWING UPDATE	JLZ 05/21/18'	~	

NOTES:
 1. Hardwares are all Nickel plated.
 2. PART NUMBER CODE:
 DS1045 - 37 X X X X X X - X

Hood Materials
 A: ABS
 B: Similar ABS

Washer type
 1: Metal

Bolt type
 L: Long
 S: Short
 Packing type
 1: Mix packing
 Q: Full packing

Cover Material
 P: Plastic(ABS)
 Cover Color
 A: Gray
 B: Black
 V: Ivory
 Position
 37: 37pin

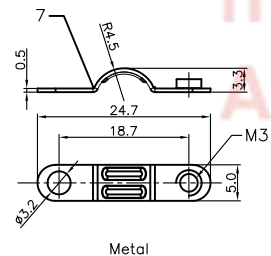
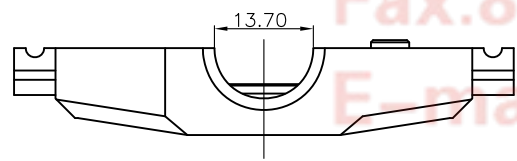
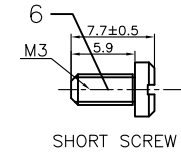
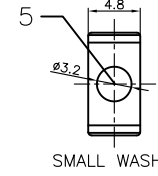
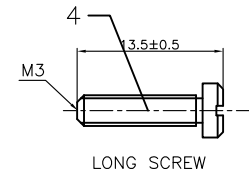
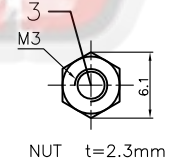
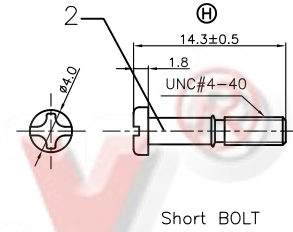
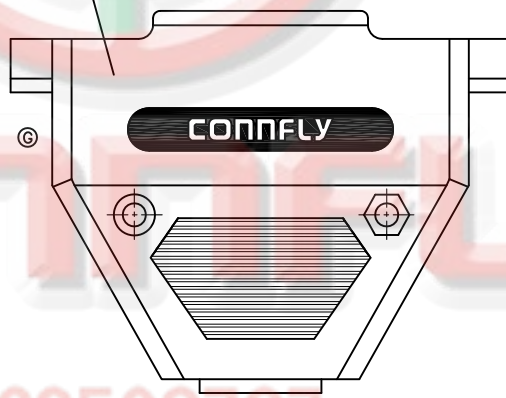
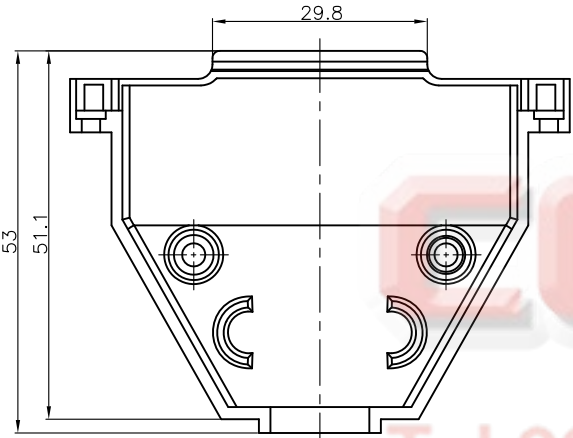
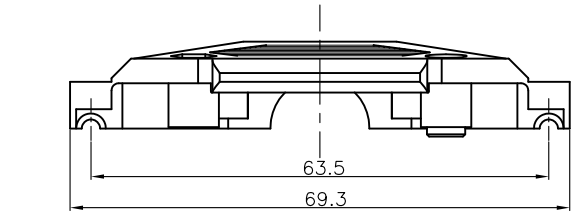
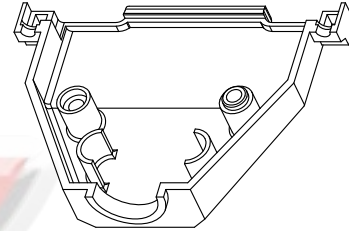

Tel:86-574-63508787
 Fax:86-574-63510817
 E-mail:sales@connfly.com
 http://www.connfly.com

GENERAL TOLERANCE		ANGLE TOLERANCE	
X.	±0.60	X.	±5°
.X	±0.38	.X	±3°
.XX	±0.25	.XX	±2°

PROJECTION	TITLE	D-SUB Plastic Hood 180°y 37 Positions	
UNITS	mm	SHEET SIZE	A4
SHEET SIZE	A4	SERIES	DS1045 SERIES

DRAWING TYPE	CUSTOMER
SCALE	1:1
DRAWING NO.	C-DS1045-37XXXXX-X-L

CONNFLY 晨翔电子有限公司
CONNFLY ELECTRONIC CO., LTD

REV.	DESCRIPTION	DRAWN	CHECKED	APPROVED
A	NEW RELEASE	YCH 05/24/11'	~	LJC 05/24/11'
B	ADD P/N CODE	LJC 12/24/13'	~	LJC 12/24/13'
C	Arrange Drawing	JLZ 10/09/14'	~	LJC 10/09/14'
L	DRAWING UPDATE	JLZ 05/21/18'	~	

NOTES:

1. Hardwares are all Nickel plated.
2. PART NUMBER CODE:

DS1045 - 50 X X X - X

- Hood Materials®
 - A: ABS
 - B: Similar ABS
- Packing type
 - 1: Mix packing
- Cover Color
 - A: Gray
 - B: Black
- Cover Material
 - P: Plastic(ABS)
- Position
 - 50: 50pin

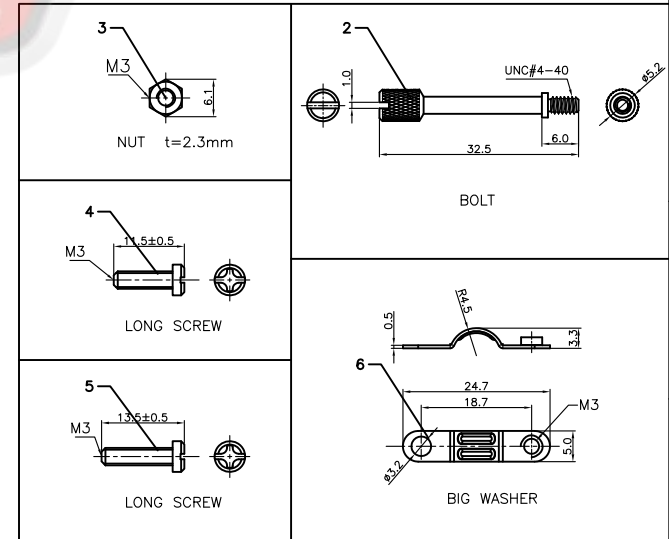
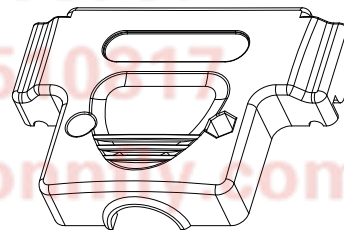
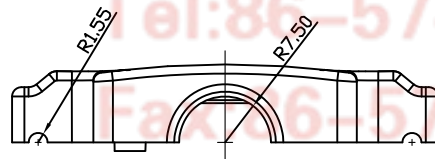
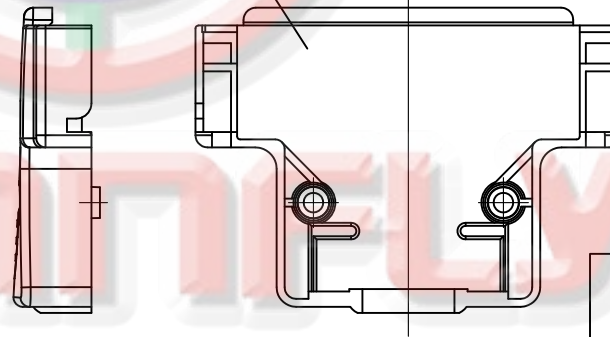
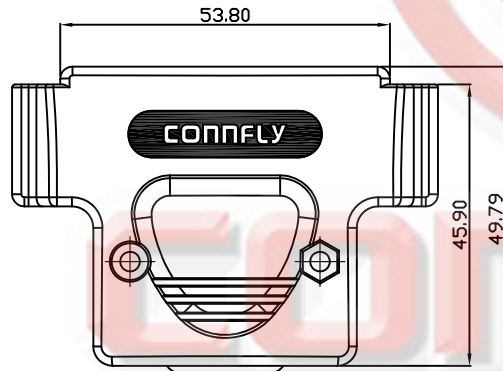
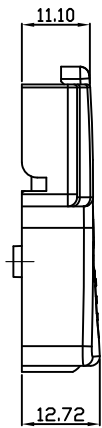
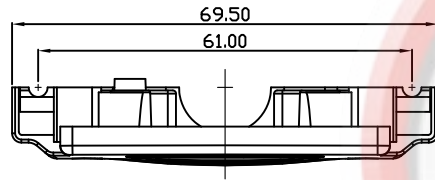

BOM LIST			
ITEM	PART NAME	Q'ty	NOTES
1	PLASTIC HOOD	2	SEE P/N
2	BOLT	2	#4-40
3	NUT	2	M3
4	M3*10 SCREW	2	M3
5	M3*12 SCREW	2	M3
6	BIG WASHER	2	M3

GENERAL TOLERANCE		ANGLE TOLERANCE	
X.	±0.60	X.	±5°
.X	±0.38	.X	±3°
.XX	±0.25	.XX	±2°
DRAWING TYPE		CUSTOMER	
SCALE	1:1	SHEET	1 OF 1
DRAWING NO.	C-DS1045-50XXX-X-L		

PROJECTION	TITLE	D-SUB Plastic Hood 180°y 50 Positions	
UNITS	mm	SHEET SIZE	A4
SHEET SIZE	A4	SERIES	DS1045 SERIES

晨翔电子有限公司
CONNFLY® CONNFLY ELECTRONIC CO., LTD

Tel: 86-574-63508787
 Fax: 86-574-63508117
 E-mail: sale@connfly.com
<http://www.connfly.com>
 Add: East Industry Zone Kingpin
 Town Ciba, Ningbo, China
 P.C. 315333