

REV.	DESCRIPTION	DRAWN	CHECKED	APPROVED
A	NEW RELEASE	JLZ 05/20/17'		

NOTES:

1.SPECIFICATION

- .CURRENT RATING: 5A Max.
- .DIELECTRIC WITH STANDING VOLTAGE: 1000V(AC)
- .CONTACT RESISTANCE: 20mΩ Max.
- .INSULATION RESISTANCE: 1000MΩ(DC)Min

2.PRODUCT NUMBER CODE:

DS1110-16 - X X X X

- SHELL SURFACE FINISHED  
N: Nickel
- CONTACT PLATING  
6: Tin
- COLOR OF HOUSING:  
B: Black
- No. OF CONTACTS  
02: 2pin 03: 3pin  
04: 4pin 05: 5pin  
06: 6pin 07: 7pin

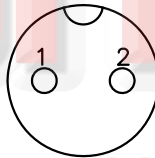
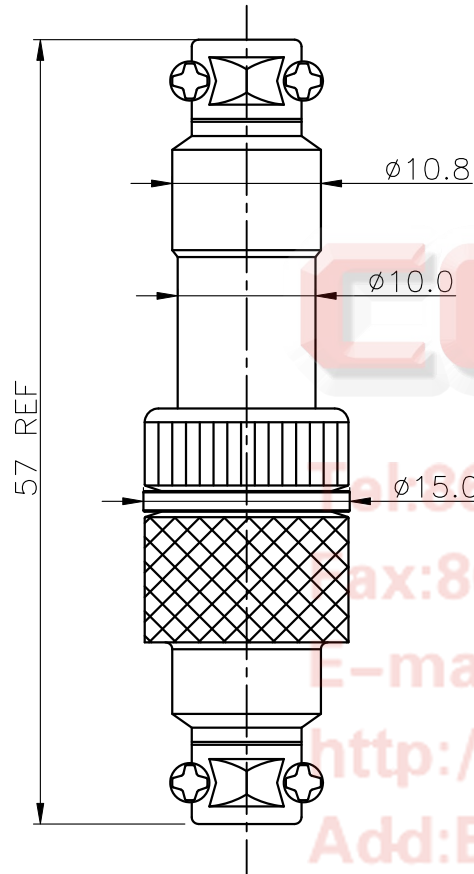

2 PIN

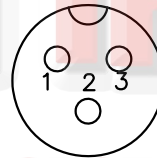

3 PIN

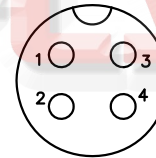

4 PIN

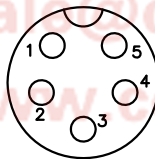

5 PIN

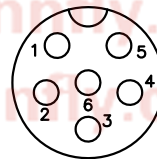

6 PIN

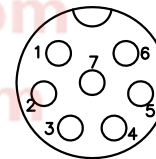

7 PIN

GENERAL TOLERANCE		ANGLE TOLERANCE		PROJECTION		TITLE	Micro Jack Total Length=57mm Ref
X.	±0.60	X.	±5°	UNITS	mm	(Pin Ø1.2) Wire To Wire Threaded Type.	
.X	±0.38	.X	±3°	SHEET SIZE	A4	SERIES	DS1110-16 SERIES
.XX	±0.25	.XX	±2°	晨翔电子有限公司 <b>CONNFLY CONNFLY ELECTRONIC CO. LTD</b>			
DRAWING TYPE		CUSTOMER					
SCALE	1:1	SHEET	1 OF 1				
DRAWING NO.		C-DS1110-16-XXXX-A					