

REV.	DESCRIPTION	DRAWN	CHECKED	APPROVED
A	NEW RELEASE	JLZ 05/20/17'		

NOTES:

1.SPECIFICATION

- .CURRENT RATING: 5A~7A.
- .DIELECTRIC WITH STANDING VOLTAGE: 1000V(AC)
- .CONTACT RESISTANCE: 20mΩ Max.
- .INSULATION RESISTANCE: 1000MΩ(DC)Min

2.PRODUCT NUMBER CODE:

DS1110-21 - X X X X

- SHELL SURFACE FINISHED
N: Nickel
- CONTACT PLATING
6: Tin
- COLOR OF HOUSING:
B: Black

No. OF CONTACTS
02: 2pin 03: 3pin
04: 4pin 05: 5pin
06: 6pin 07: 7pin
08: 8pin 09: 9pin
10: 10pin

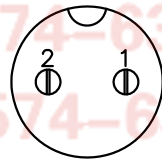
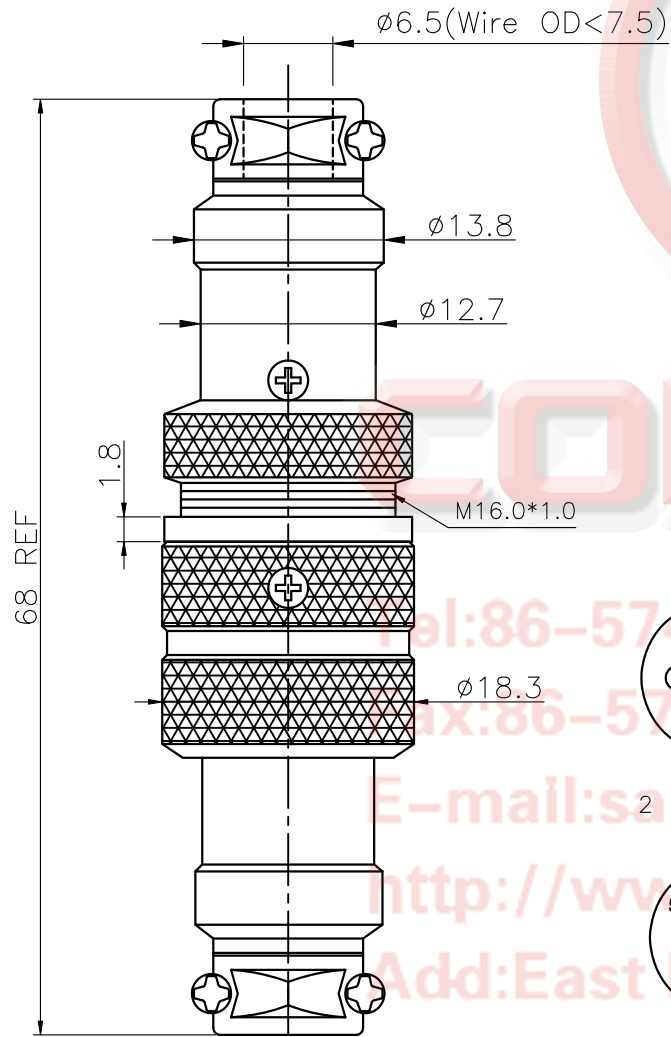

2 PIN($\phi 2.5$ 7A)

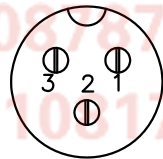

3 PIN($\phi 2.5$ 7A)

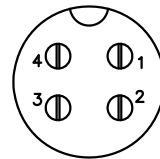

4 PIN($\phi 2.5$ 7A)

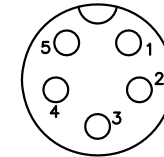

5 PIN($\phi 2.0$ 7A)

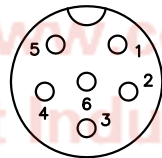

6 PIN($\phi 1.2$ 5A)

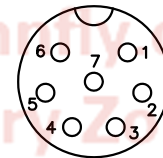

7 PIN($\phi 1.2$ 5A)

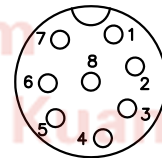

8 PIN($\phi 1.2$ 5A)

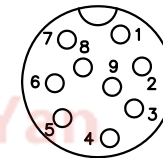

9 PIN($\phi 1.2$ 5A)

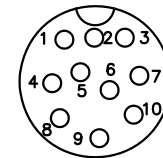

10 PIN($\phi 1.2$ 5A)

GENERAL TOLERANCE		ANGLE TOLERANCE		PROJECTION	TITLE
X.	± 0.60	X.	$\pm 5^\circ$		Micro Jack Total Length=68mm Ref
.X	± 0.38	.X	$\pm 3^\circ$	mm	(Pin $\phi 1.2 \sim 2.5$) Wire To Wire Threaded Type
.XX	± 0.25	.XX	$\pm 2^\circ$	A4	SERIES DS1110-21 SERIES
DRAWING TYPE		CUSTOMER		晨翔电子有限公司 CONNFLY CONNFLY ELECTRONIC CO. LTD	
SCALE		1:1 SHEET 1 OF 1			
DRAWING NO.		C-DS1110-21-XXXX-A			