

10 9 8 7 6 5 4 3 2 1

F F

E E

D D

C C

B B

A A

10 9 8 7 6 5 4 3 2 1

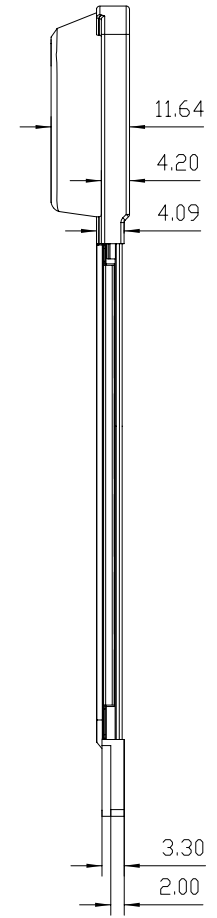
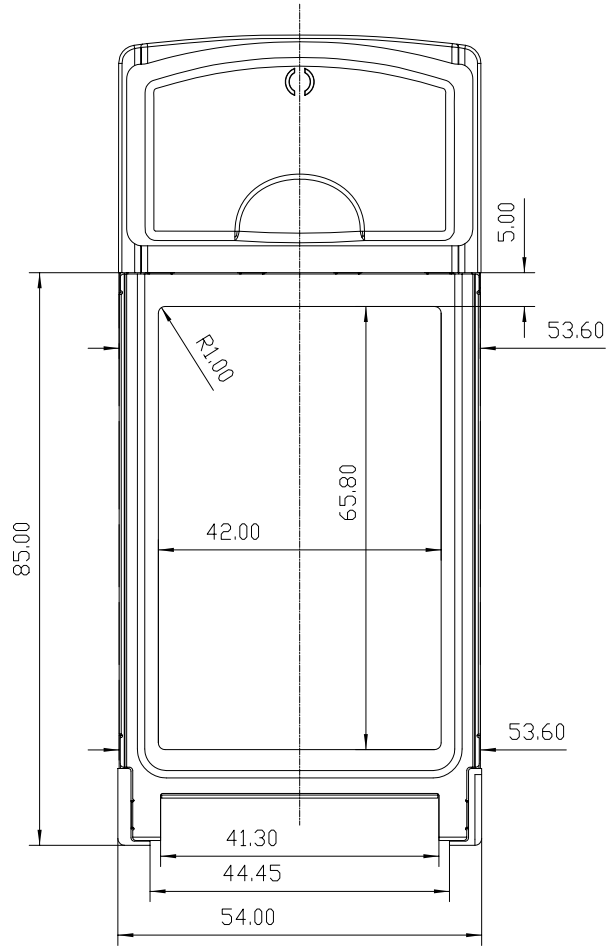
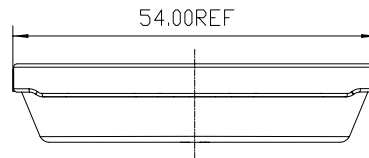
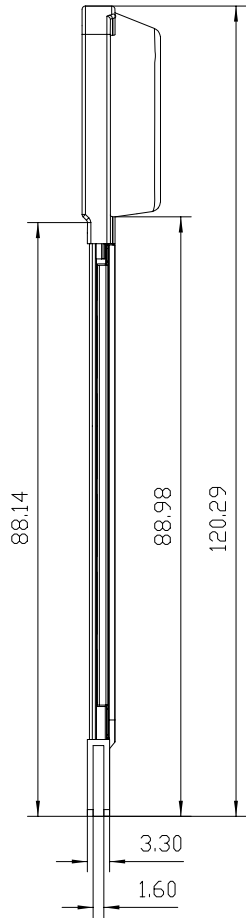
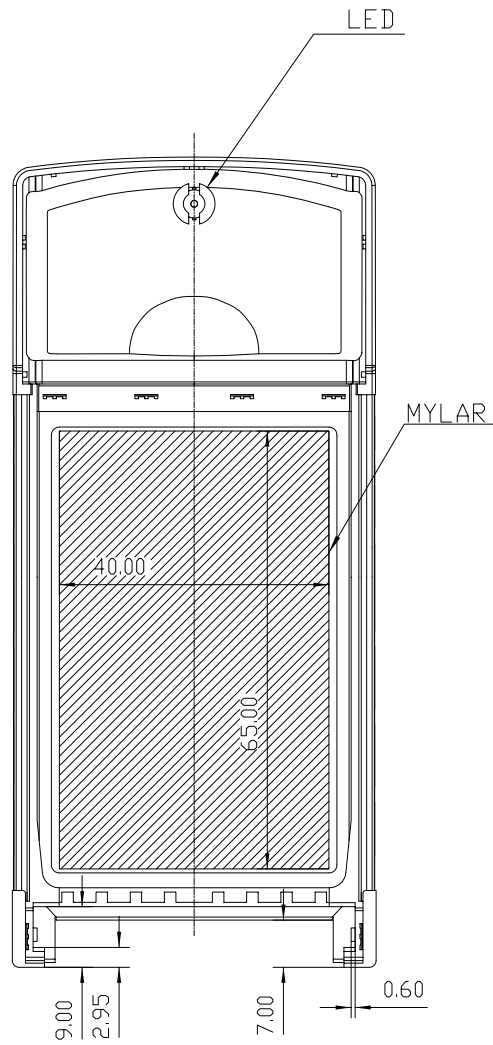

- NOTES:  
 1.COVER MATERIAL:METAL COVER :SUS 304 0.20mm  
 2.HOUSING :PC&ABS ,COLOR:SEE DRAWING2  
 3.MYLAR:SKC INSULATION MYLAR OR DUPONT INSULATION  
 4.LED:PC

C	REV	GENERAL TOLERANCES (UNLESS SPECIFIED)		SCALE	DESIGN UNITS	TITLE	
		mm	INCH	N/A	METRIC		
		4 PLACES	± ---	± ---	THIRD ANGLE PROJECTION		WIRELESS LAN CARD TOP ID FRAME COVER
		3 PLACES	± ---	± ---			
2 PLACES	± 0.20	± ---	SYMBOLS MAJOR CRITICAL QUALITY <input checked="" type="checkbox"/> = 0 <input type="checkbox"/> = 0	REVISE ON CAD ONLY			
1 PLACE	± 0.20	± ---					
ANGULAR ± 2°				MATERIAL NO.	SEE DRAWING2	SHEET NO. 1 OF 2	

10

9

8

7

6

5

4

3

2

1

F

F

E

E

D

D

C

C

B

B

A

A

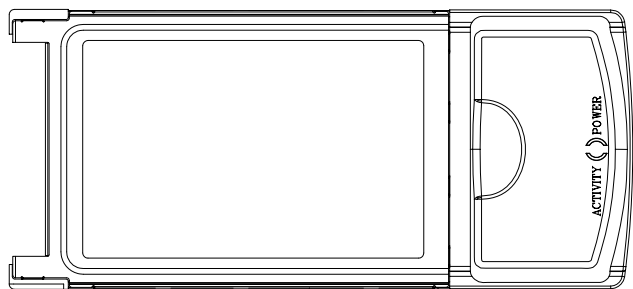

P/N:WL922-ZC31  
 COLOR:BLACK

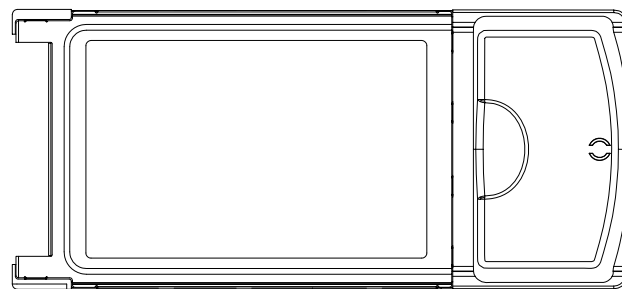

P/N:WL922-ZC30  
 COLOR:BLACK

DESCRIPTION	GENERAL TOLERANCES (UNLESS SPECIFIED)		SCALE N/A	DESIGN UNITS METRIC	TITLE  WIRELESS LAN CARD TOP ID FRAME COVER
	4 PLACES	mm	INCH	THIRD ANGLE PROJECTION	
	3 PLACES	---	---		
	2 PLACES	± 0.20	---		
	1 PLACE	± 0.20	---		
ANGULAR ± 2°					
SYMBOLS	MAJOR	CRITICAL	REVISE ON CAD ONLY		
QUALITY	☒ = 0	▨ = 0			
MATERIAL NO.	SEE DRAWING				SHEET NO. 2 OF 2

10

9

8

7

6

5

4

3

2

1