

BOM LIST			
ITEM	PART NAME	Q'ty	NOTES
1	PLASTIC HOOD	2	SEE P/N
2	LONG BOLT	2	#4-40
	SHORT BOLT	2	#4-40
3	NUT	2	M3
4	LONG SCREW	2	M3
5	SMALL WASHER	2	
6	SHORT SCREW	2	M3
7	7.1 METAL WASHER	2	M3
	7.2 PLASTIC-1 WASHER	2	ABS
	7.3 PLASTIC-2 WASHER	2	ABS

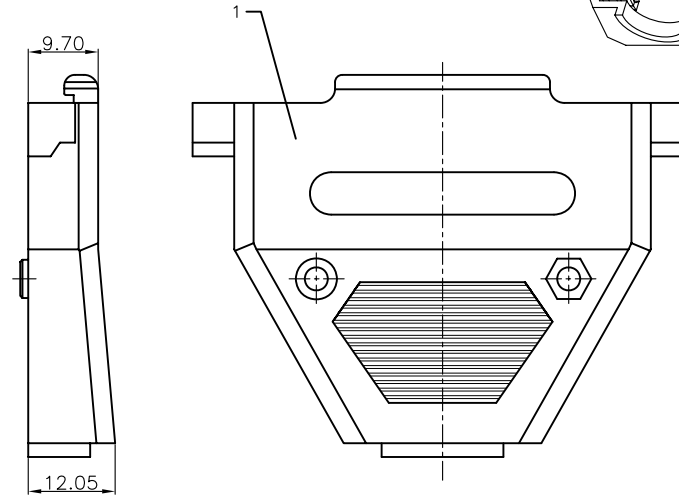

REV.	DESCRIPTION	DRAWN	CHECKED	APPROVED
A	NEW RELEASE	LJH 10/26/05'	~	LJC 10/26/05'
B	整理图面	YCH 09/13/07'	~	LJC 09/13/07'
C	整理英制短螺丝尺寸	YCH 07/18/08'	~	LJC 07/18/08'
D	增加“全包装”类型	YCH 05/20/10'	~	LJC 05/20/10'
E	ADD P/N CODE	LJC 12/24/13'		

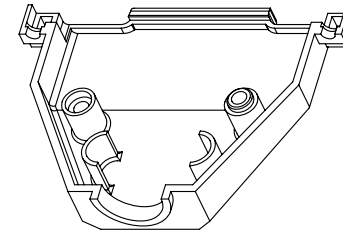

NOTES:
 1. Hardwares are all Nickel plated.
 2. PART NUMBER CODE:
 DS1045 - 37 X X X X X - X

Hood Materials (E)
 A: ABS
 B: Similar ABS

Washer type
 1: Metal
 2: Plastic-1(Lock type)
 3: Plastic-2(Screw type)

Bolt type
 L: Long
 S: Short

Packing type
 1: Mix packing
 2: Separation packing
 Q: Full packing

Cover Material
 P: Plastic(ABS)

Cover Color
 A: Gray
 B: Black
 V: Ivory

Position
 37: 37pin

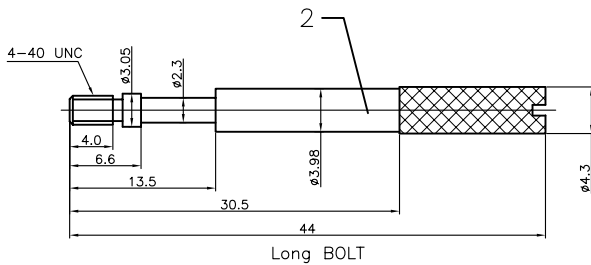
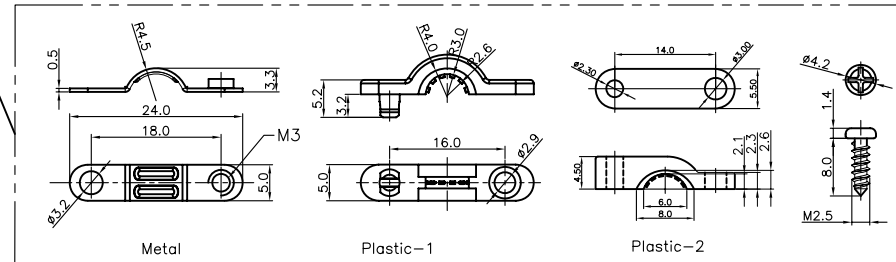
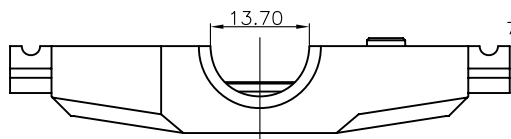
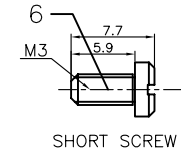
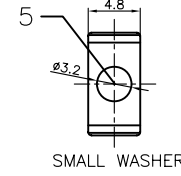
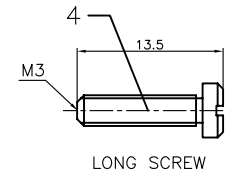
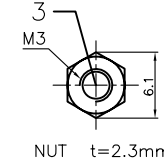
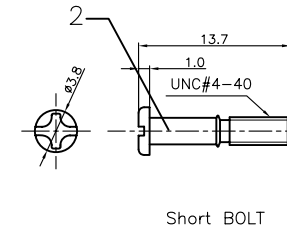

GENERAL TOLERANCE		ANGLE TOLERANCE	
X.	±0.60	X.	±5°
.X	±0.38	.X	±3°
.XX	±0.25	.XX	±2°

PROJECTION	TITLE	D-SUB Plastic Hood 180° 37 Positions	
UNITS	mm	SHEET SIZE	A4
SHEET SIZE	A4	SERIES	DS1045 SERIES

DRAWING TYPE	COSTOMER		
SCALE	1:1	SHEET	1 OF 1
DRAWING NO.	C-DS1045-37XXXXX-X-E		

晨翔电子有限公司
CONNFLY ELECTRONIC CO., LTD