

ID	Description	Date	By	Appr.
A				

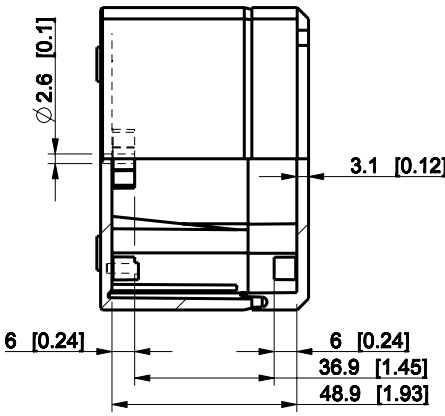
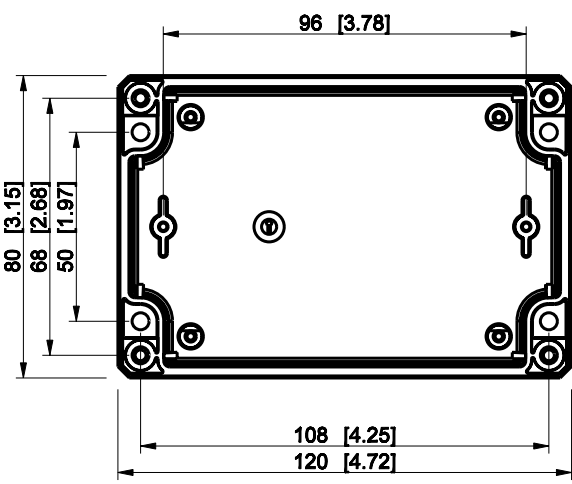
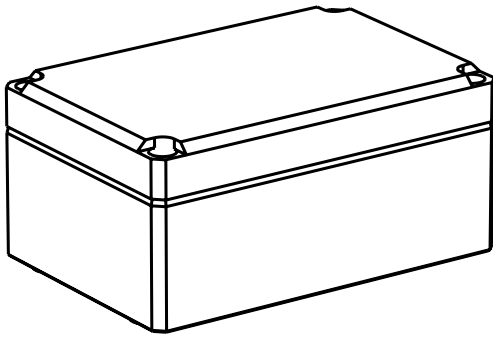
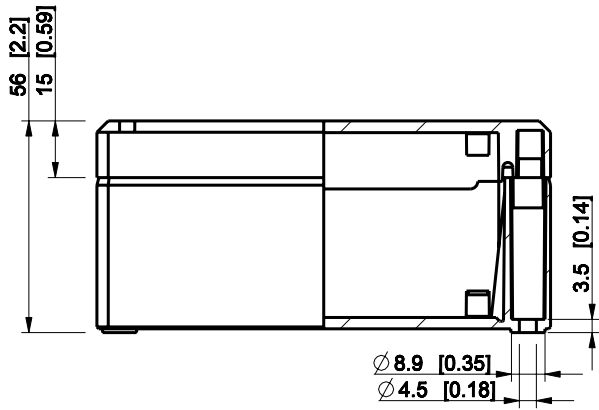

Dimensions in mm [inches]

Material: ABS	Color: RAL 7035
---------------	-----------------

Supplier:	Tool No:	Weight [kg]: 0.15	Volume:
-----------	----------	-------------------	---------



DABP081206G

Scale	Date	18.12.08
1:2	By	PKos
-	Checked	
-	Ctrl	

Replaces:	
Replaced:	
Drw No:	A
Ref:	-
Code:	DABP081206G
Sheet No:	

model DABP081206G PART
 drawing CUBO_D_2_DRAWING