

ID	Description	Date	By	Appr.
A				

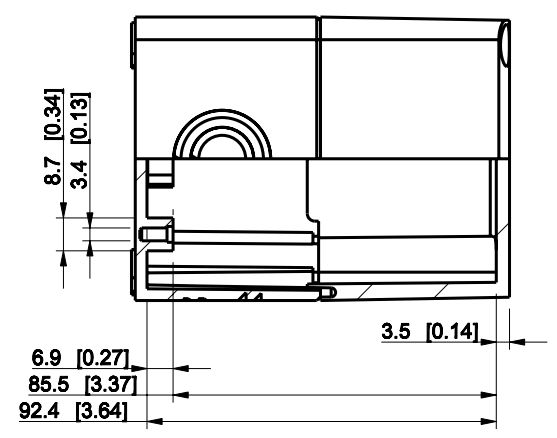
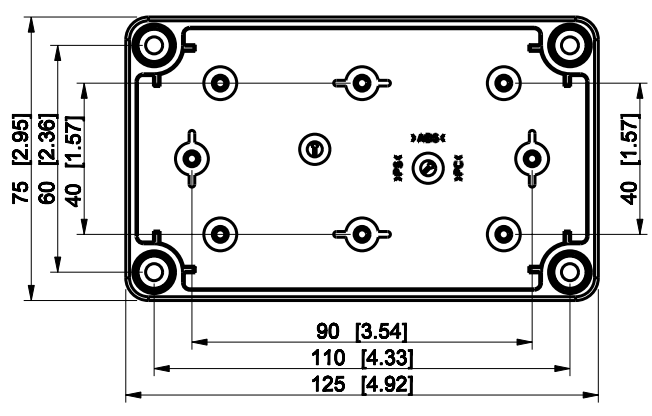
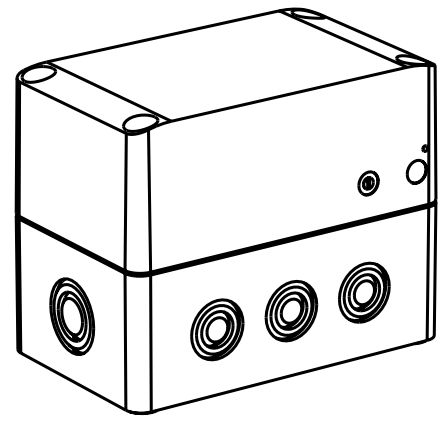
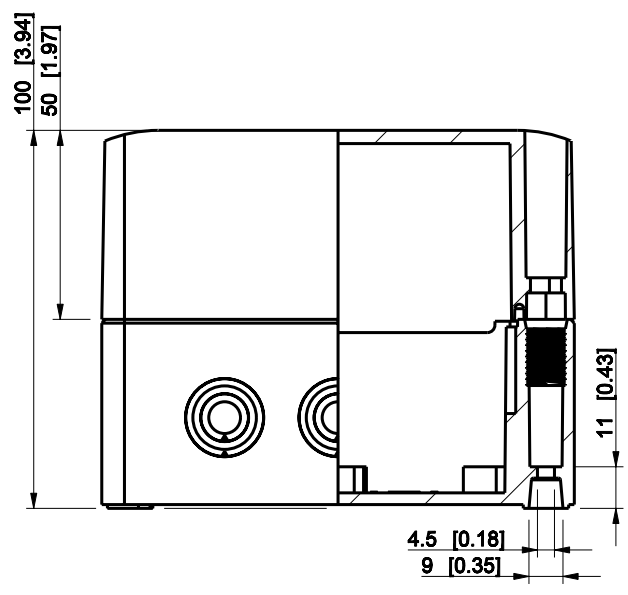

Dimensions in mm [inches]

Material: Polycarbonate, fiberglass-reinforced	Color: RAL 7035
--	-----------------

Supplier:	Tool No:	Weight [kg]: 0.24	Volume:
-----------	----------	-------------------	---------



SPCM081310T

Scale	Date	08.12.08
1:2	By	PKos
-	Checked	
-	Ctrl	

Replaces:	
Replaced:	
Drw No:	- A
Ref:	Cubo S
Code:	SPCM081310T
Sheet No:	

model SPCM081310T PART
drawing CUBOS DRAWING