

ID	Description	Date	By	Appr.
A				

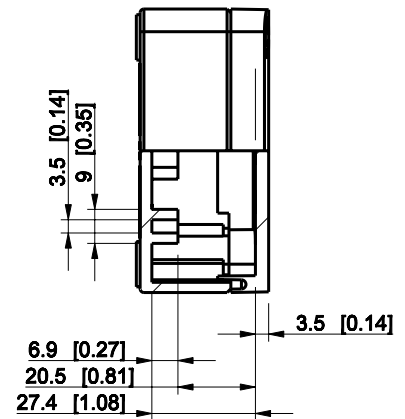
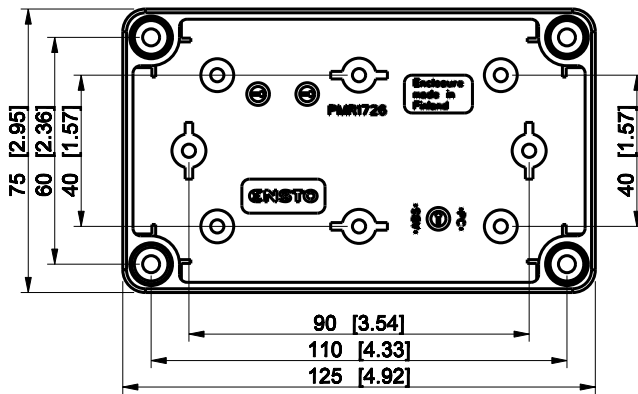
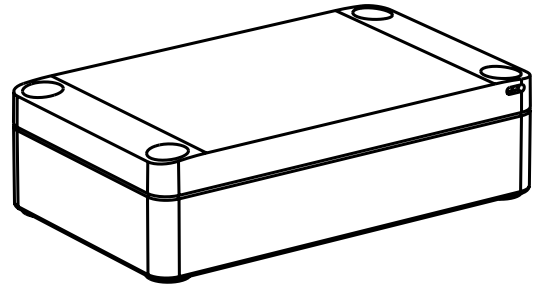
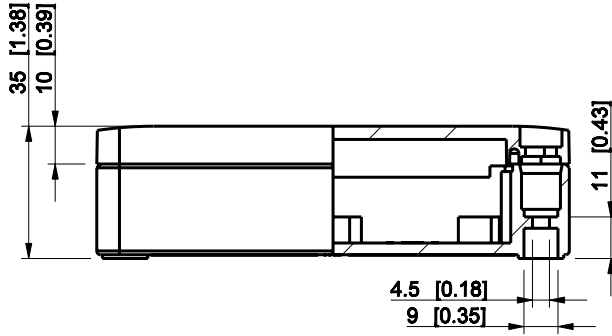

Dimensions in mm [inches]

Material: Polycarbonate, fiberglass-reinforced	Color: RAL 7035
--	-----------------

Supplier:	Tool No:	Weight [kg]: 0.12	Volume:
-----------	----------	-------------------	---------



**SPCP081304LG**

Scale	Date	04.12.08
1:2	By	PKos
-	Checked	
-	Ctrl	

Replaces:
Replaced:
Drw No: - A
Ref: Cubo S
Code: SPCP081304LG
Sheet No:

model SPCP081304LG PART  
drawing CUBOS\_3\_DRAWING