

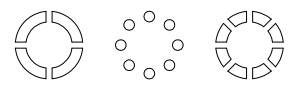

NOTE :
 1.Material: Brass
 2.Plate : Sn
 3.The surface should be clean
 4.Dimension : 1.00(H)-3.6(Ø)-M2.0

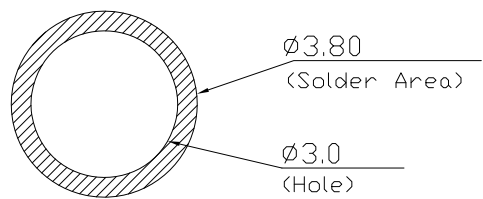
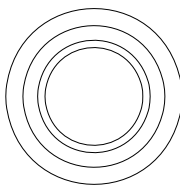
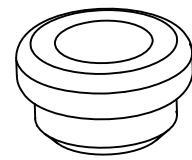
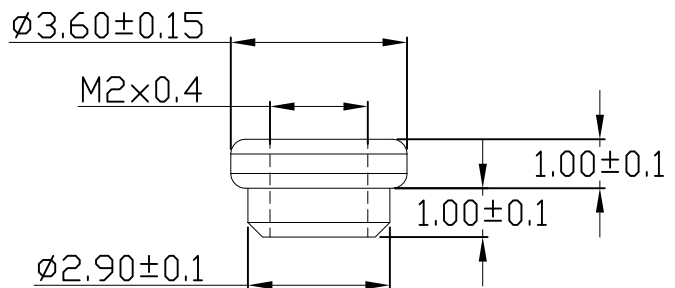

Stencil Masking Examples

PROPRIETARY NOTE: This document contains confidential information and proprietary to Rego Electronics and shall not be reproduced or disclosed to other documents or used for any purpose other than that for which was obtained without the expressed written consent of Rego Electronics.			
.X ± 0.30	APPROVED: Chris	 http://www.rego.com.tw	
.XX ± 0.20	CHECKED: Andy		
.XXX ± 0.15	DRAWN: Vic		
X* ± 3'	UNITS: mm	SCALE: NONE	TITLE: Stand Off $\phi 3.60 \times 2.00$ mm (H:1.0) PART NO: SO-M20H10D360 SHEET: 1 OF 2

A	05.11.2019
REV	DATE

1 2 3 4 5 6 7 8 9 10

A
B
C
D
E
F

1. Part conforms to EIA-481-D standards.
2. All dimensions in millimetres unless otherwise stated.
3. Material : Conductive polystyrene.
4. Packing length for 22" reel : 75.0 Meters. (1:3)
5. Component packing to 13" reel : 3000 pcs.

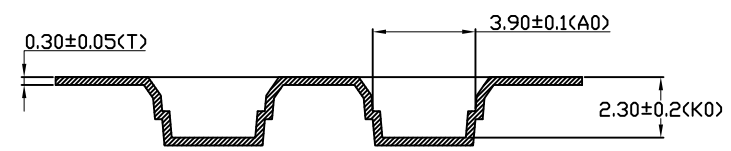
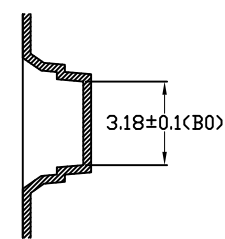
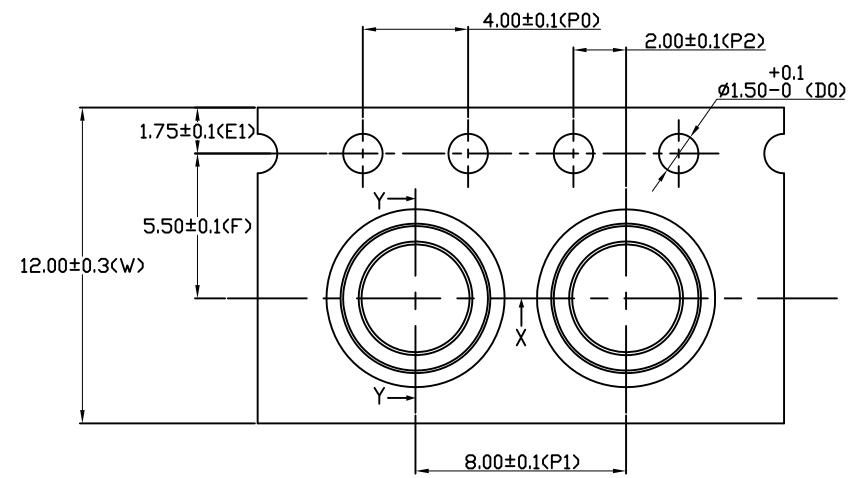

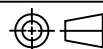
PROPRIETARY NOTE: This document contains confidential information and proprietary to Rego Electronics and shall not be reproduced or disclosed to other documents or used for any purpose other than that for which was obtained without the expressed written consent of Rego Electronics.			
.X ± 0.30	APPROVED: Chris	 http://www.rego.com.tw	TITLE: Stand Off $\phi 3.60 \times 2.00$ mm (H:1.0)
.XX ± 0.20	CHECKED: Andy		
.XXX ± 0.15	DRAWN: Vic		
X* ± 3°			
 UNITS: mm SCALE: NONE	PART NO: SO-M20H10D360		SHEET: 2 OF 2

0	27.09.2013
REV	DATE

1 2 3 4 5 6 7 8 9 10