

COIL FORMER

General data 12-pins ER34/17/11 coil former

PARAMETER	SPECIFICATION
Coil former material	phenolformaldehyde (PF), glass-reinforced, flame retardant in accordance with "UL 94V-0"; UL file number E59481
Pin material	copper-tin alloy (CuSn), tin (Sn) plated
Maximum operating temperature	180°C, "IEC 60085", class H
Resistance to soldering heat	"IEC 60068-2-20", Part 2, Test Tb, method 1B, 350 °C, 3.5 s
Soldeerability	"IEC 60068-2-20", Part 2, Test Ta, method 1

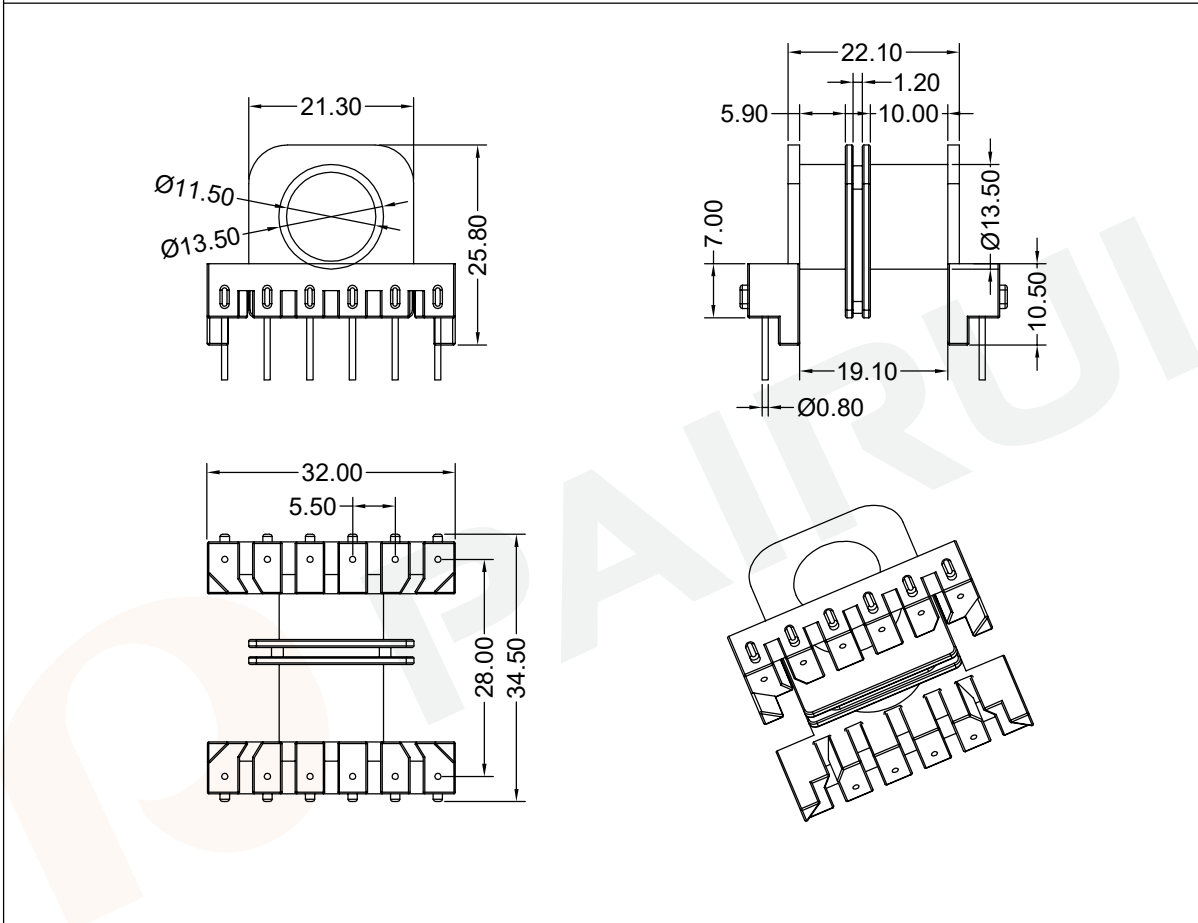

Winding data and area product for 12-pins ER34/17/11 coil former

NUMBER OF SECTIONS	WINDING AREA (mm ²)	MINIMUM WINDING WIDTH (mm)	AVERAGE LENGTH OF TURN (mm)	AREA PRODUCT Ae x Aw (mm ⁴)	TYPE NUMBER
1	62	5.9+10.0	55	5700	ER-3401-2S-12P

Tolerances unless otherwise specified:
 0<L≤4±0.10 4<L≤16±0.20
 16<L≤45±0.30 45≤L±0.40
 Pin Dim:±0.05 Thickness:±0.20 Pin Pitch:±0.20

Dimensions:
(mm)



REMARK

Mould No.: ER3401

Bobbin material: T378J

Code No.: FAY01091

Available for Fuan core: ER34/17/11



Fuan Electronics

TEL :0086-514-87693589
 EML :sales@fuantronics.net
 WEB:www.fuantronics.net

Make: P.Xiao

Material Number: A47340100100

Checked: Beson. zhan

Document/Rev: 00

Approved: Anson. zhan

Date of Recognition: Oct./09/2019