

Size 16B Sleeve housing, Top opening hole

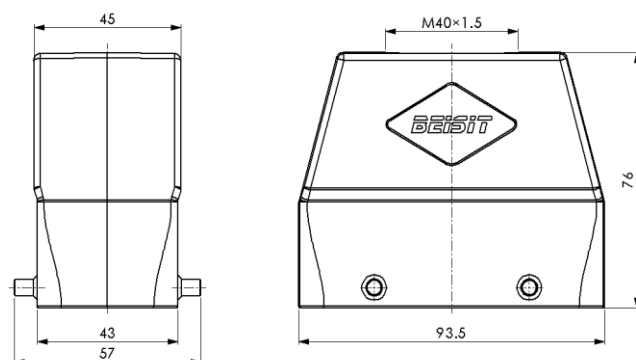

Typecode H16B-TOH-4P-M40

ID 1 007 01 0000899

Technical Data

Product Properties

Series	Size 16B
Mating with	HE-016, HEE-032, HEEE-040, HD-040, HDD-072, HK-004/0, HSB-6
Housing type	Sleeve housing
Cable outlets direction	Top opening hole
Cable outlets	M40 x 1.5
Protection Class	IP65
Impact strength	IK08
Temperature range	-40 °C ... 125 °C
Standard	DIN EN 175301-801

Insert

Housing material	Die-cast aluminum
Color	Gray (RAL 7037)

Commercial data

Weight	213 g
Packaging unit	1 pc
Country of origin	CN

Features

- Die casting of aluminum
- Top opening hole
- Resistant to salt spray
- Approval: UL94-V0
- RoHS-compliant

*The design data are listed here, and the changes to the product are not described here. For unfinished matters, please contact customer service. It is the user's responsibility to verify functionality, compliance with applicable laws and instructions, and electrical safety in specific applications.