

# SPECIFICATION FOR APPROVAL

REF :

PAGE: 1

PROD. NAME	SMD POWER INDUCTOR	ABC'S DWG NO.	SB7045□□□□L□-□□□
		ABC'S ITEM NO.	

## I . CONFIGURATION & DIMENSIONS :

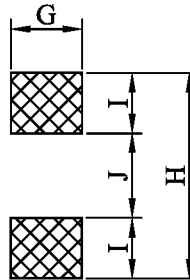
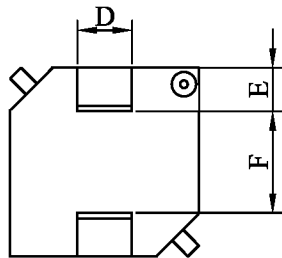
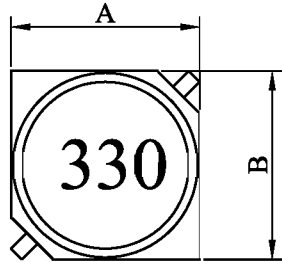

(PCB Pattern)

- A : 7.0±0.3 m/m
- B : 7.0±0.3 m/m
- C : 4.5±0.3 m/m
- D : 2.0 typ. m/m
- E : 1.5 typ. m/m
- F : 4.0 typ m/m
- G : 2.4 ref. m/m
- H : 7.8 ref. m/m
- I : 1.8 ref. m/m
- J : 4.2 ref. m/m

## II . SCHEMATIC DIAGRAM :

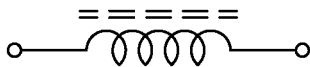

## III . MATERIALS :

- a . Core : Ferrite DR core
- b . Wire : Enameled copper wire ( class F )
- c . Terminal : Cu / Ni / Sn
- d . Base : LCP Base
- e . Adhesive : Epoxy resin
- f . Remark : Products comply with RoHS' requirements

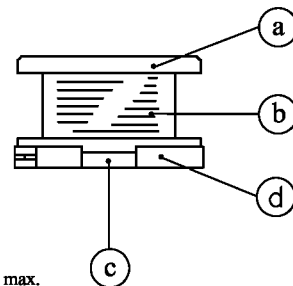

Peak Temp : 260°C max.  
 Max time above 230°C : 50sec max.  
 Max time above 200°C : 70sec max.

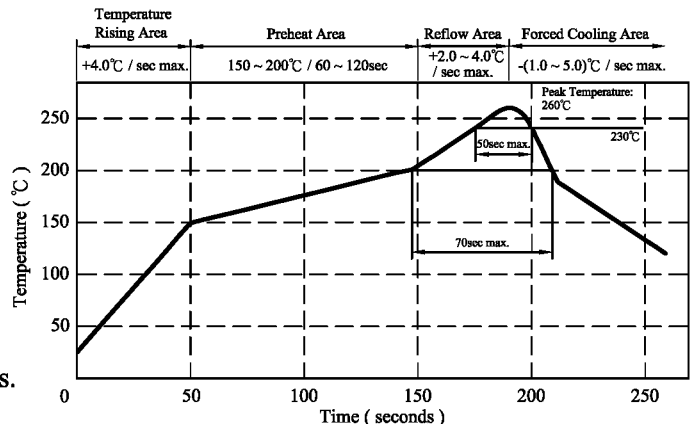

## IV . GENERAL SPECIFICATION :

- a . Temp. rise : 40°C max.
- b . Storage Temp. : -40°C ----+125°C
- c . Operating Temp. : -40°C ----+125°C  
(Temp. rise included)
- d . Resistance to solder heat : 260°C.10 secs.

AR-001A

# SPECIFICATION FOR APPROVAL

REF :

PAGE: 2

PROD. NAME	SMD POWER INDUCTOR	ABC'S DWG NO. ABC'S ITEM NO.	SB7045□□□□L□-□□□
---------------	--------------------	---------------------------------	------------------

## V . ELECTRICAL CHARACTERISTICS :

DWG No.	Inductance ( $\mu$ H) 100KHz / 0.1V	Q ref.	Test Freq. (MHz)	SRF (MHz) typ.	RDC ( $\Omega$ ) max.	Irms (A) max.	Isat (A) typ.
SB70451R2ML□-□□□	1.2 $\pm$ 20%	25	7.96	90	0.022	3.80	5.00
SB70451R5ML□-□□□	1.5 $\pm$ 20%	26	7.96	109	0.027	3.50	4.50
SB70452R2ML□-□□□	2.2 $\pm$ 20%	24	7.96	79	0.032	3.30	4.00
SB70453R3ML□-□□□	3.3 $\pm$ 20%	23	7.96	47	0.036	2.80	3.70
SB70454R7ML□-□□□	4.7 $\pm$ 20%	23	7.96	38	0.042	2.60	3.40
SB70456R8ML□-□□□	6.8 $\pm$ 20%	22	7.96	35	0.054	2.25	2.70
SB7045100ML□-□□□	10.0 $\pm$ 20%	28	2.52	23	0.070	2.00	2.30
SB7045150ML□-□□□	15.0 $\pm$ 20%	24	2.52	19	0.086	1.60	1.90
SB7045220ML□-□□□	22.0 $\pm$ 20%	26	2.52	18	0.125	1.40	1.62
SB7045330ML□-□□□	33.0 $\pm$ 20%	20	2.52	18	0.150	1.22	1.32
SB7045470KL□-□□□	47.0 $\pm$ 10%	21	2.52	11	0.230	1.00	1.10
SB7045680KL□-□□□	68.0 $\pm$ 10%	17	2.52	11	0.280	0.90	0.92
SB7045101KL□-□□□	100.0 $\pm$ 10%	17	0.796	10	0.430	0.75	0.72
SB7045151KL□-□□□	150.0 $\pm$ 10%	17	0.796	8	0.580	0.62	0.58
SB7045221KL□-□□□	220.0 $\pm$ 10%	22	0.796	6	0.930	0.50	0.48
SB7045331KL□-□□□	330.0 $\pm$ 10%	20	0.796	6	1.240	0.42	0.40
SB7045471KL□-□□□	470.0 $\pm$ 10%	20	0.796	4	1.850	0.34	0.30
SB7045681KL□-□□□	680.0 $\pm$ 10%	18	0.796	4	2.400	0.30	0.26
SB7045102KL□-□□□	1000.0 $\pm$ 10%	48	0.252	3	4.000	0.22	0.20

- 1). □ : Packaging information ... [A] : Bulk [B] : Taping Reel
- 2). "□□□":Reference code
- 3). Irms Base on Temp. rise 40°C max.
- 4). Isat Base on  $\Delta L/L0A=10\%$  typ.

@ Inductance VS. DC Superposition Characteristics

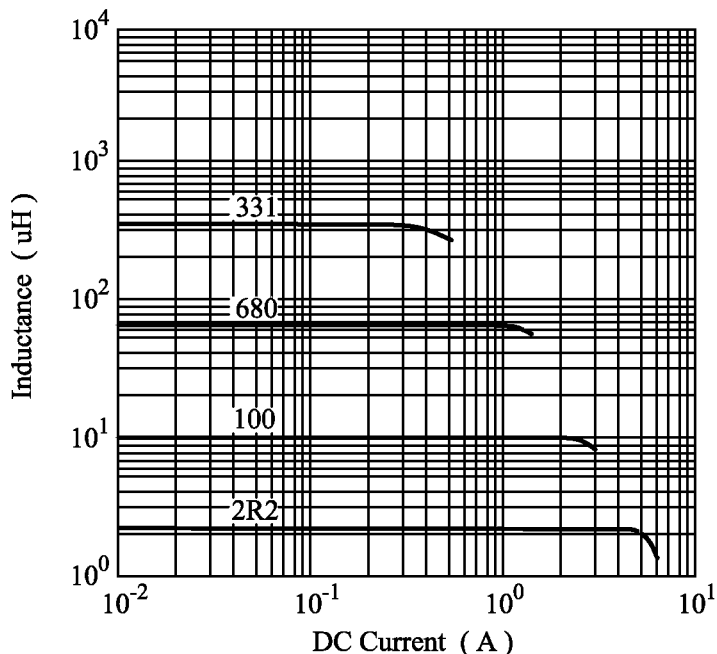

AR-001A

# SPECIFICATION FOR APPROVAL

REF :

PAGE: 3

PROD. NAME	SMD POWER INDUCTOR	ABC'S DWG NO.	SB7045□□□□L□-□□□
		ABC'S ITEM NO.	

**VI . PACKAGING INFORMATION :**

(1) Configuration

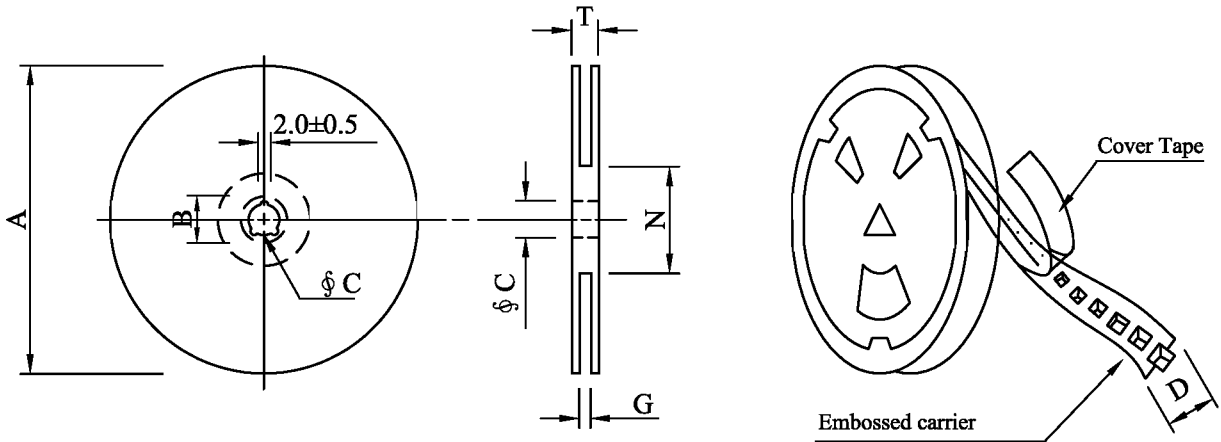

※Carrier Tape width : D

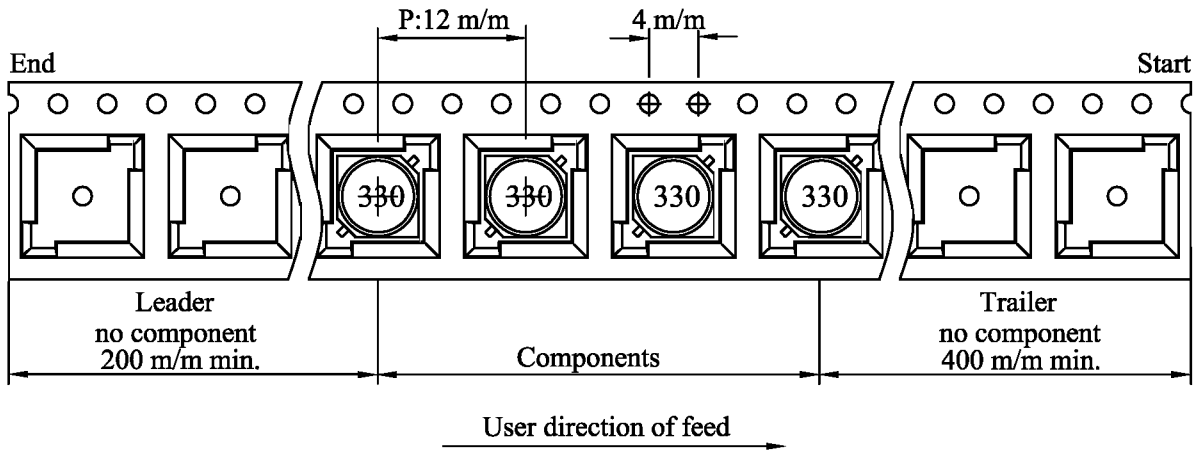

(2) Dimensions

Unit:m/m

STYLE	A	B	C	D	G	N	T
13 - 16	330	21±0.8	13±0.5	16	18 <sup>+0</sup>	50 <sup>-0</sup>	22.4

(3) Q'TY & G.W. Per package

Series	Inner : Reel			Outer : Carton		
	Q'TY (pcs)	G.W. (gw)	Style	Q'TY (pcs)	G.W. (Kg)	Size (cm)
SB7045	1,000	255	13 - 16	6,000	1.84	40 x 40 x 24

# SPECIFICATION FOR APPROVAL

REF :

PAGE: 4

PROD. NAME	SMD POWER INDUCTOR	ABC'S DWG NO.	SB7045□□□□L□-□□□
		ABC'S ITEM NO.	

**VII . DWGING NUMBER EXPRESSION :**

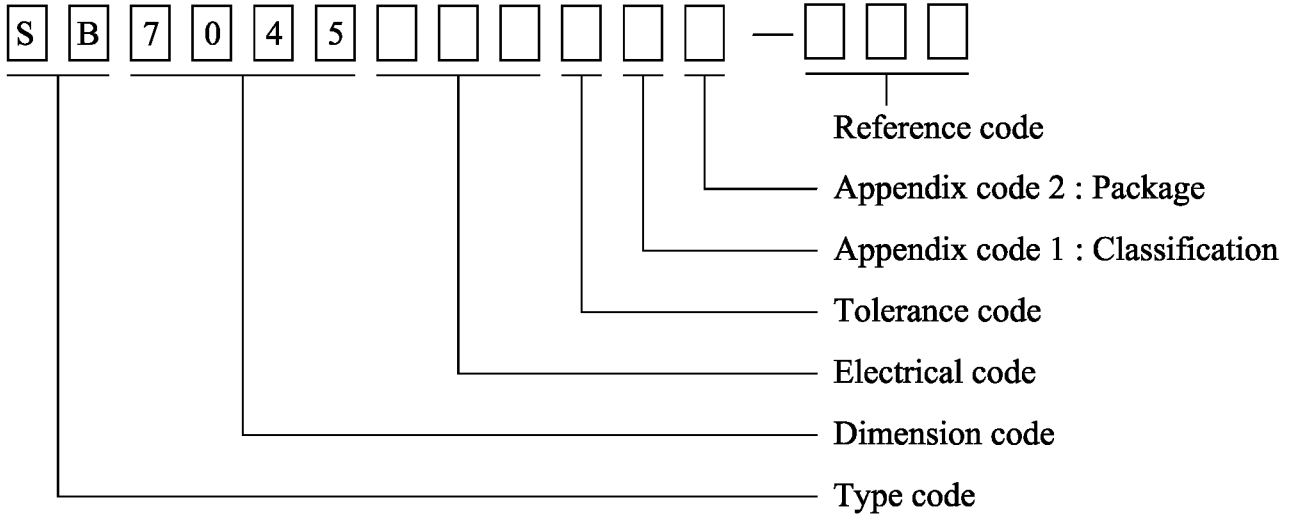

**Appendix code 1 : Product Classification**

- L : Lead Free Standard products comply with RoHS' requirements
- 1 ~ 9 : Lead Free Special products comply with RoHS' requirements

**Appendix code 2 : Package Information**

Code	Inner package	Inner package Q'TY	Remark
A	T.B.D.	T.B.D.	
B	T / R ( Reel package )	1000 pcs	

# SPECIFICATION FOR APPROVAL

REF :

PAGE: 5

PROD. NAME	SMD POWER INDUCTOR	ABC'S DWG NO.	SB7045□□□□L□-□□□
		ABC'S ITEM NO.	

**VIII . RELIABILITY TEST :**

Test item	Specification	Test condition						
Solderability	More than 90% of the terminal electrode shall be covered With fresh solder.	Preheat : 150±25°C for 60 seconds Solder : Sn96.5 / Ag3 / Cu0.5 or equivalent Solder temp. : 235±5°C Flux : Rosin Dip time : 4±1 seconds						
Thermal shock test ( Temp. cycle )	Inductance shall not change more than ±20%	<table style="width: 100%; border: none;"> <tr> <td style="text-align: center;">Room temp. 15 minutes</td> <td style="text-align: center;">—————&gt;</td> <td style="text-align: center;">-25±2 °C 30 minutes</td> </tr> <tr> <td style="text-align: center;">Room temp. 15 minutes</td> <td style="text-align: center;">—————&gt;</td> <td style="text-align: center;">85±2 °C 30 minutes</td> </tr> </table> <p>Total : 50 cycles</p>	Room temp. 15 minutes	—————>	-25±2 °C 30 minutes	Room temp. 15 minutes	—————>	85±2 °C 30 minutes
Room temp. 15 minutes		—————>	-25±2 °C 30 minutes					
Room temp. 15 minutes		—————>	85±2 °C 30 minutes					
Humidity Resistance test		Temperature : 40±2°C Humidity : 90 ~ 95% Applied current : Per spec. Time : 500 hours						
High temp. Resistance test	Temperature : 85±2°C Applied current : Per spec. Time : 500 hours							

# SPECIFICATION FOR APPROVAL

REF :

PAGE: 6

PROD. NAME	SMD POWER INDUCTOR	ABC'S DWG NO.	SB7045□□□□L□-□□□
		ABC'S ITEM NO.	

**IX. UL CARD :**

OBMW2 September 8, 2000

Magnet Wire-Component

JUNG SHING WIRE CO LTD E174837

231 CHUNG CHENG RD, SEC 3 JEN-TEH HSIANG, TAINAN

HSIEN TAIWAN

Mtl Dsg	Mark Dsg	BC	Coat Typ	OC	ANSI Type	Temp Class
AIW	---	Polyamideimide	---	---	MW81-C	220
CFUEWB	---	Polyurethane	---	---	MW75C	130
EIAIW	---	Polyesterimide	Polyamideimide	---	MW35C	200
EILOCKY	---	Polyesterimide	Polyamide	---	---	180
EILOCKW	---	Polyesterimide	Modified Epoxy	---	---	200
EIW	---	Polyesterimide	---	---	---	220
EIW-2	---	Polyesterimide	---	---	MW74-C	200
FL.EILOCKY	---	Modified Polyester	Polyamide	---	---	155
LSFFW	---	Polyurethane	---	---	MW79-C	155
LSUEW	---	Polyurethane	---	---	---	130
PEW	---	Polyester	---	---	---	155
PEY	---	Polyester	Nylon	---	MW24-C	155
SF.FLW	---	Modified Polyester	---	---	MW26C	155
SF.EIW	---	Polyesterimide	---	---	MW77C	180
SF.BY@	---	Modified Polyester	---	Nylon	MW27-C	155
SF.FLY@	---	Modified Polyester	---	Nylon	MW27-C	155
SF.BLOCKBS	---	Modified Polyester	---	Modified Polyamide	---	155
SF.EILOCKY#	---	Polyesterimide	---	Polyamide	---	180
SF.EILOCKBS	---	Polyesterimide	---	Modified Polyamide	---	180
SF.BW@	---	Modified Polyester	---	---	MW26C	155
SFFW	---	Polyurethane	---	---	MW79	155

287806002 Page 1 of 2

A not-for-profit organization  
dedicated to public safety and  
committed to quality service

Mtl Dsg	Mark Dsg	BC	Coat Typ	OC	ANSI Type	Temp Class
SFFY	---	Polyurethane	---	Polyamide	MW80C	155
UEW-1	---	Polyurethane	---	---	MW2-C	105
UEW-2	---	Polyurethane	---	---	---	130
UEW-4	---	Polyurethane	---	---	MW75C	130
UEY	---	Polyurethane	---	Nylon	MW28-C	130
UEY-2	---	Polyurethane	---	Polyamide	MW28-C	130

@-May be suffixed by LZ; # - May be suffixed by LZ, EL or LZL.  
LZ - Signifies magnd wires twisted together; EL - signifies base coated magnet wire laid parallel with top coat applied overall; LZL - signi-  
fies base coated magnet wire twisted together and covered with top coat overall.

Marking: Company name or trademarks **JSW** or 榮星電線, material designation or marked designation on packaed or reel, and  
Recognized Component Mark.

See General Information Preceding These Recognitions  
For use only in equipment where the acceptability of the combination is determined by Underwriters Laboratories Inc.

287806002 Page 2 of 2

OBMW2/E174837  
September 8, 2000

# SPECIFICATION FOR APPROVAL

REF :

PAGE: 7

PROD. NAME	SMD POWER INDUCTOR	ABC'S DWG NO.	SB7045□□□□L□-□□□
		ABC'S ITEM NO.	

SUMITOMO CHEMICAL CO LTD										E54705 (M)				
5-33 KITAHAMA 4-CHOME CHUO-KO, OSAKA JAPAN														
Mtl Dsg	Col	Min Thk mm	UL94 Flame Class	Elec	RTI		H W I	H A I	H V T R	D 4 5	C T I			
					Mech with Imp	w/o Imp								
Liquid crystal polyester (LCP), designated "EKONOL" or "SUMIKASUPER", furnished in the form of pellets, (Contd)														
E4008, E400X	NC, BK	0.30	94V-0	130	130	130	—	—	—	—	—			
		0.75	94V-0	130	130	130	3	4	—	—	—			
		1.5	94V-0	130	130	130	2	4	—	—	—			
		3.0	94V-0	130	130	130	1	4	0	5	4			
E4008	NC, WT, BK	0.30	94V-0	130	130	130	—	—	—	—	—			
		0.75	94V-0	220	180	220	3	4	—	—	—			
		1.5	94V-0	220	200	240	2	4	—	—	—			
		3.0	94V-0	220	200	240	1	4	0	5	4			
E4010	NC, BK	0.30	94V-0	130	130	130	—	—	—	—	—			
		0.75	94V-0	220	180	220	3	4	—	—	—			
		1.5	94V-0	220	200	240	2	4	—	—	—			
		3.0	94V-0	220	200	240	1	4	0	5	4			
E400(Y)L, E4008L	NC, BK	0.30	94V-0	130	130	130	—	—	—	—	—			
		0.75	94V-0	130	130	130	3	4	—	—	—			
		1.5	94V-0	130	130	130	2	4	—	—	—			
		3.0	94V-0	130	130	130	1	4	0	5	4			
E4810	NC, BK	0.30	94V-0	130	130	130	—	—	—	—	—			
		0.75	94V-0	130	130	130	0	4	—	—	—			
		1.5	94V-0	130	130	130	0	4	—	—	—			
		3.0	94V-0	130	130	130	1	4	0	5	4			

(X) Denotes any number 1 thru 9.  
(Y) Denotes any number 1 thru 7.