

# SPECIFICATION FOR APPROVAL

REF :

PAGE: 1

PROD. NAME	SHIELDED SMD POWER INDUCTOR	ABC'S DWG NO.	SD1205□□□□1□-□□□
		ABC'S ITEM NO.	

## I . MECHANICAL DIMENSIONS :

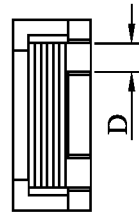
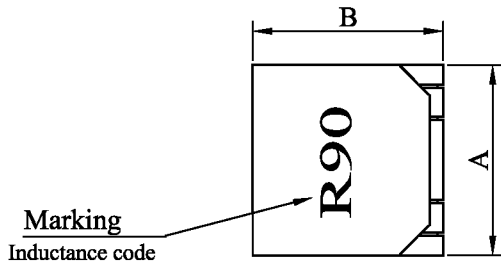

A	: 12.50±0.30	m/m
B	: 12.50±0.30	m/m
C	: 5.00±0.50	m/m
D	: 1.90±0.20	m/m
E	: 2.50 nom.	m/m
E1	: 3.00 ref.	m/m
E2	: 2.00 ref.	m/m
F	: 7.50±0.25	m/m
F1	: 6.40 ref.	m/m
F2	: 5.20 ref.	m/m
H	: 10.50 ref.	m/m
I	: 4.15 ref.	m/m
J	: 3.00 ref.	m/m
K	: 13.00 ref.	m/m
M	: 4.70 ref.	m/m
N	: 4.50 ref.	m/m
P	: 7.50 ref.	m/m

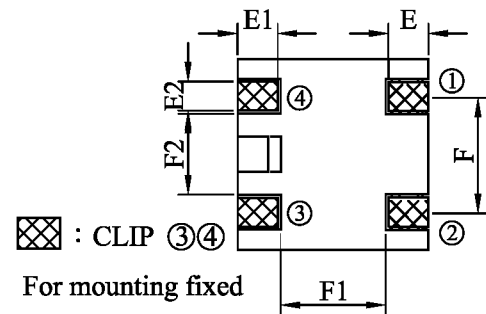
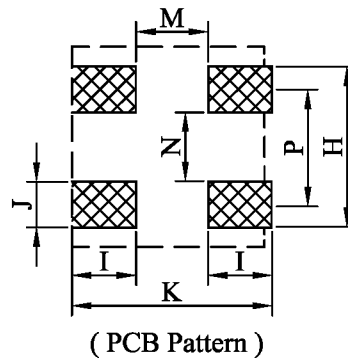
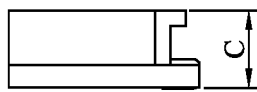

For mounting fixed

## II . SCHEMATIC DIAGRAM :

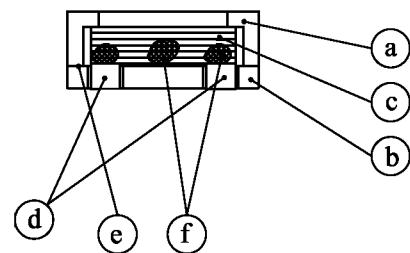
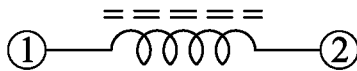

## III . MATERIALS LIST :

- a . Core : Ferrite ER core
- b . Core : Ferrite SB core
- c . Wire : Ultra-fine rectangular  
Enamelled copper wire ( class F )
- d . Terminal : Cu/Sn
- e . Adhesive : Epoxy resin
- f . Adhesive : Epoxy resin
- g . Remark : Products comply with RoHS' requirements

Peak Temp : 260°C max.  
Max time above 230°C : 50sec max.  
Max time above 200°C : 70sec max.

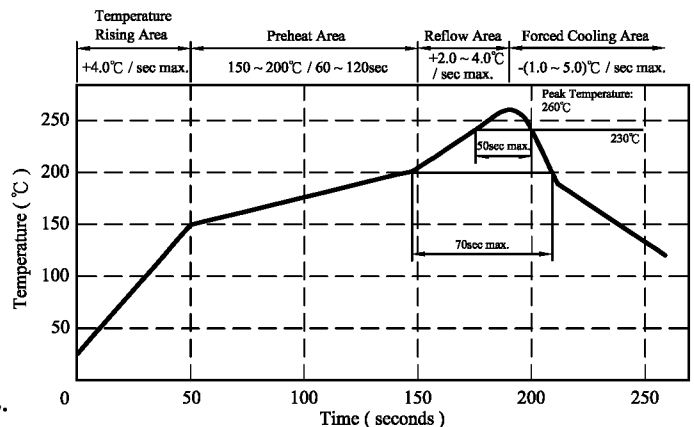

## IV . GENERAL SPECIFICATION :

- a . Temp. rise : 40°C max.
- b . Storage temp. : -40°C ~ +125°C
- c . Operating temp. : -40°C ~ +105°C
- d . Resistance to solder heat : 260°C. 10 secs.

AR-001A

# SPECIFICATION FOR APPROVAL

REF :

PAGE: 2

<b>PROD. NAME</b>	<b>SHIELDED SMD POWER INDUCTOR</b>	<b>ABC'S DWG NO.</b>	SD1205□□□□1□-□□□
		<b>ABC'S ITEM NO.</b>	

**V . ELECTRICAL CHARACTERISTICS :**

DWG No.	Initial inductance L0 ( uH )	Inductance at flat point L1 ( uH )	Flat point ref. ( A )	Irms ( A )	Isat ( A )	DC Resistance max. ( mΩ )
SD1205R90Y1□-□□□	0.90±25%	0.75±25%	5.0	18.0	20.0	2.5
SD12051R4Y1□-□□□	1.40±25%	1.25±25%	5.0	15.0	16.0	3.4
SD12052R0Y1□-□□□	2.00±25%	1.80±25%	4.0	12.0	13.0	4.6
SD12053R2Y1□-□□□	3.50±25%	3.20±25%	2.0	8.6	9.0	9.0
SD12054R6Y1□-□□□	4.80±25%	4.60±25%	2.0	8.2	7.2	10.5
SD12056R4Y1□-□□□	6.80±25%	6.40±25%	3.0	7.8	6.0	11.0
SD12058R2Y1□-□□□	8.60±25%	8.20±25%	3.0	7.2	5.4	12.0
SD1205100Y1□-□□□	10.50±25%	10.00±25%	2.0	6.5	4.7	13.5

- 1). □ : Packaging Information... [A]: Bulk [B]: Tpaing Reel
- 2). "- □□□ ":Reference code
- 3). L : 1V / 100 KHZ,HP-4274A ; RDC : CH-502AC
- 4). Measured frequrncy of inductance is 100 KHz / 1V
- 5). Isat base on inductance drop 20% max. of L1 value
- 6). Irms base on temp. rise 40°C max.

# SPECIFICATION FOR APPROVAL

REF :

PAGE: 3

PROD. NAME	SHIELDED SMD POWER INDUCTOR	ABC'S DWG NO. ABC'S ITEM NO.	SD1205□□□□1□-□□□
---------------	--------------------------------	---------------------------------	------------------

@ Inductance VS. DC Superposition Characteristics

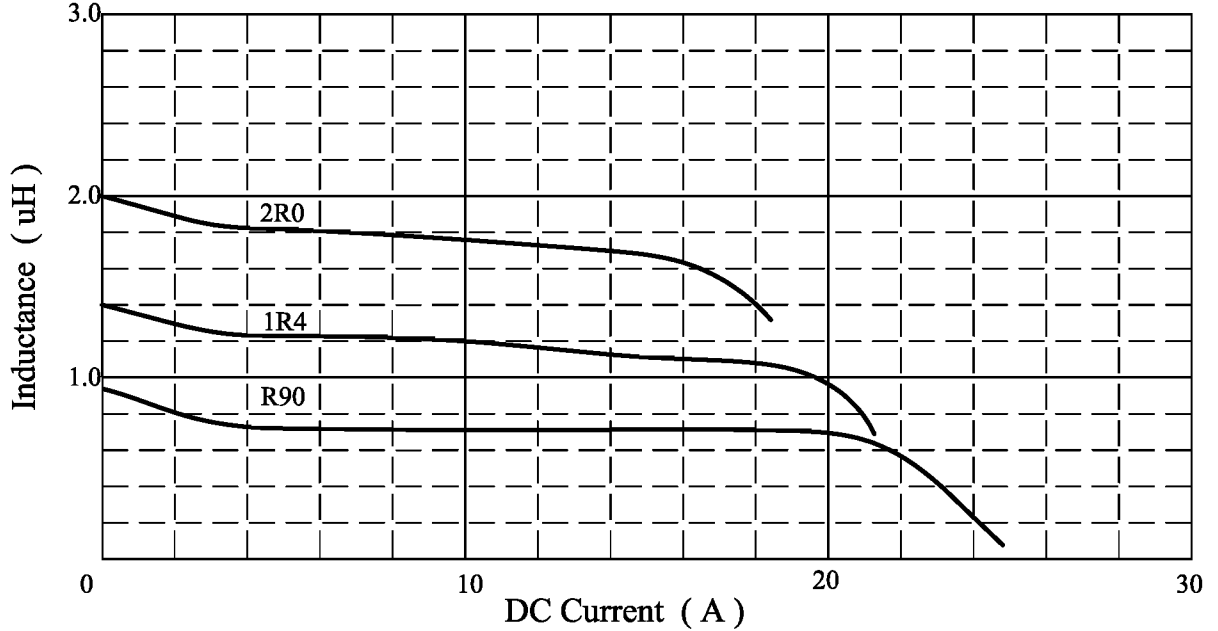

@ Inductance VS. DC Superposition Characteristics

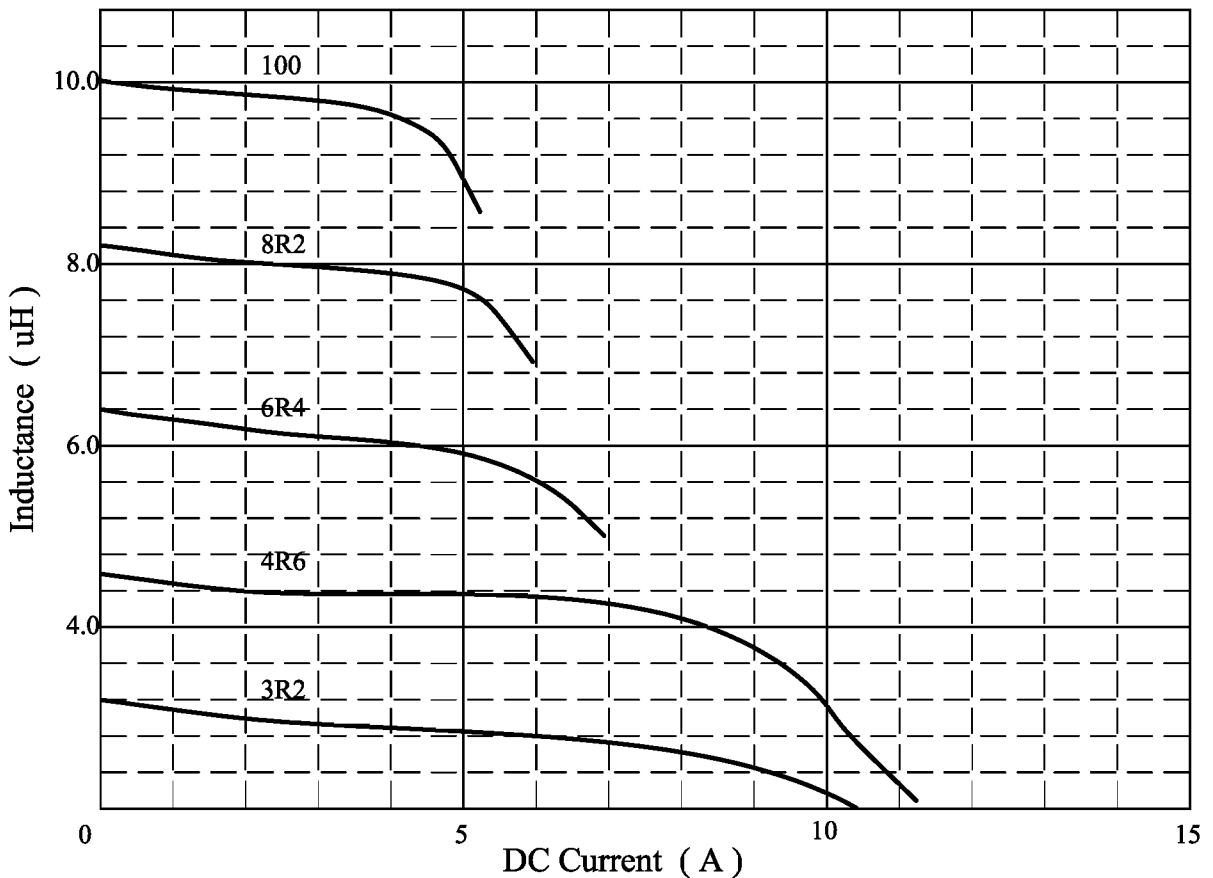

AR-001A

# SPECIFICATION FOR APPROVAL

REF :

PAGE: 4

PROD. NAME	SHIELDED SMD POWER INDUCTOR	ABC'S DWG NO.	SD1205□□□□1□-□□□
		ABC'S ITEM NO.	

## VI . PACKAGING INFORMATION :

### (1) Configuration

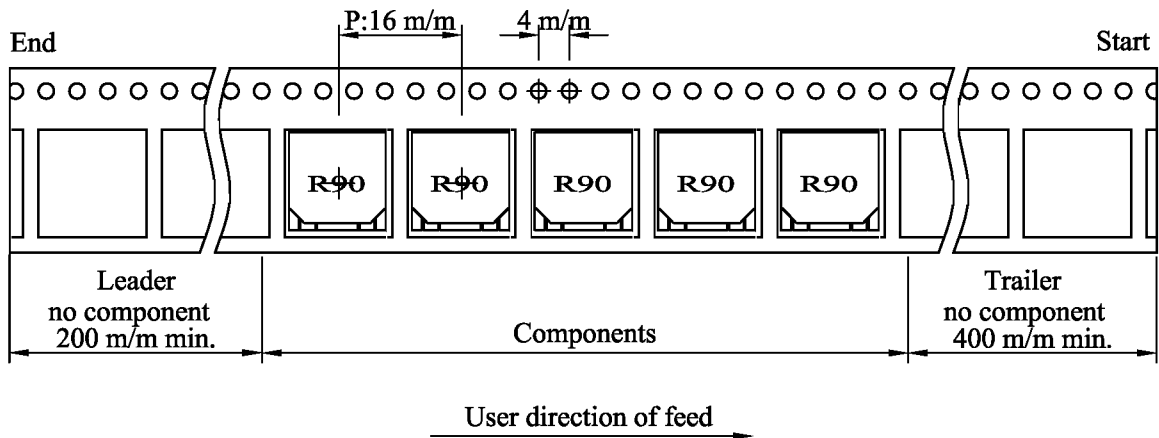
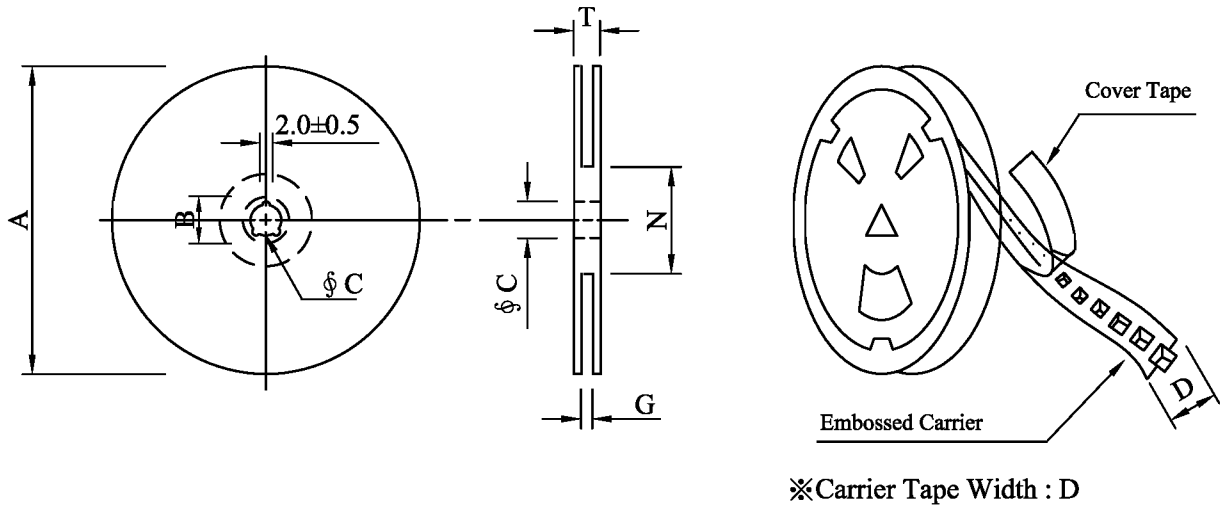

### (2) Dimensions

Unit:m/m

Style	A	B	C	D	G	N	T
13 - 24	330	21±0.8	13	24	26 <sup>+0</sup>	50 <sup>-0</sup>	30.4

### (3) Q'TY & G.W. Per package

Series	Inner : Reel			Outer : Carton		
	Q'TY (pcs)	G.W. (gw)	Style	Q'TY (pcs)	G.W. (Kg)	Size (cm)
SD1205	600	2,150	13 - 24	2,400	11.30	40 x 40 x 24

AR-001A

# SPECIFICATION FOR APPROVAL

REF :

PAGE: 5

<b>PROD. NAME</b>	<b>SHIELDED SMD POWER INDUCTOR</b>	<b>ABC'S DWG NO.</b>	SD1205□□□□1□-□□□
		<b>ABC'S ITEM NO.</b>	

**VII . DWGING NUMBER EXPRESSION :**

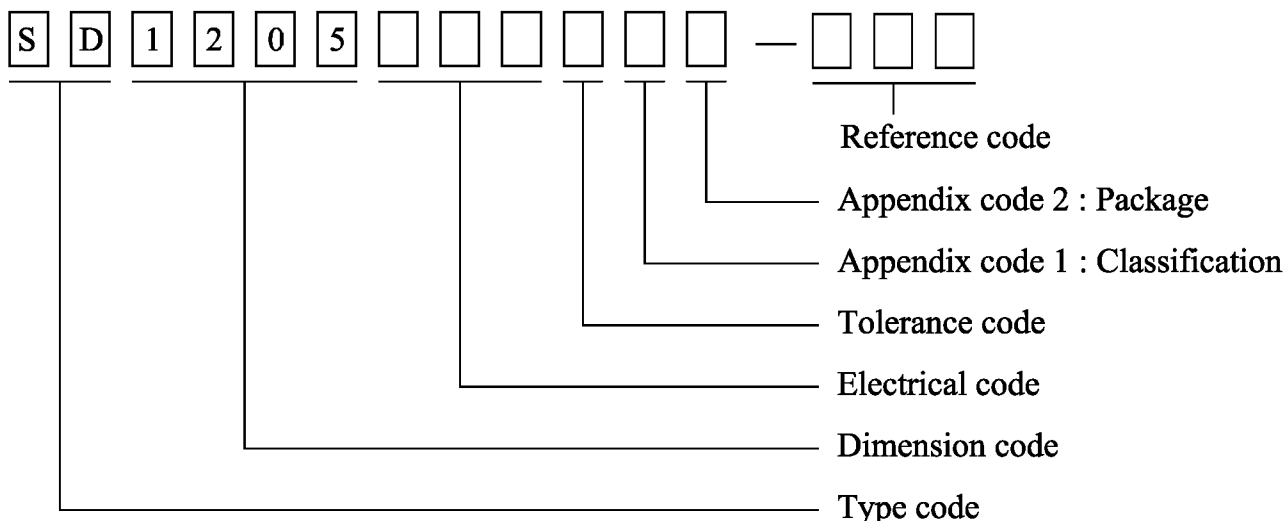

**Appendix code 1 : Product Classification**

L : Lead Free Standard products comply with RoHS' requirements

1 ~ 9 : Lead Free Special products comply with RoHS' requirements

**Appendix code 2 : Package Information**

Code	Inner package	Inner package Q'TY	Remark
A	T.B.D.	T.B.D.	
B	T / R ( Reel package )	600 pcs	

# SPECIFICATION FOR APPROVAL

REF :

PAGE: 6

<b>PROD.</b>	<b>SHIELDED SMD</b>	<b>ABC'S DWG NO.</b>	<b>SD1205□□□□1□-□□□</b>
<b>NAME</b>	<b>POWER INDUCTOR</b>	<b>ABC'S ITEM NO.</b>	

**VIII . RELIABILITY TEST :**

Test item	Specification	Test condition												
Solderability	More than 90% of the terminal electrode shall be covered With fresh solder.	Preheat : 150±25°C for 60 seconds Solder : Sn96.5 / Ag3 / Cu0.5 or equivalent Solder temp. : 235±5°C Flux : Rosin Dip time : 4±1 seconds												
Thermal shock test ( Temp. cycle )	Inductance shall not change more than ±20%	<table style="width: 100%; border: none;"> <tr> <td style="text-align: center;">Room temp.</td> <td style="text-align: center;">→</td> <td style="text-align: center;">-25±2 °C</td> </tr> <tr> <td style="text-align: center;">15 minutes</td> <td></td> <td style="text-align: center;">30 minutes</td> </tr> <tr> <td style="text-align: center;">Room temp.</td> <td style="text-align: center;">→</td> <td style="text-align: center;">85±2 °C</td> </tr> <tr> <td style="text-align: center;">15 minutes</td> <td></td> <td style="text-align: center;">30 minutes</td> </tr> </table> <p>Total : 50 cycles</p>	Room temp.	→	-25±2 °C	15 minutes		30 minutes	Room temp.	→	85±2 °C	15 minutes		30 minutes
Room temp.		→	-25±2 °C											
15 minutes			30 minutes											
Room temp.		→	85±2 °C											
15 minutes		30 minutes												
Humidity Resistance test	Temperature : 40±2°C Humidity : 90 ~ 95% Applied current : Per spec. Time : 500 hours													
High temp. Resistance test	Temperature : 105±2°C Applied current : Per spec. Time : 500 hours													

# SPECIFICATION FOR APPROVAL

REF :

PAGE: 7

PROD. NAME	SHIELDED SMD POWER INDUCTOR	ABC'S DWG NO. ABC'S ITEM NO.	SD1205□□□□1□-□□□
---------------	--------------------------------	---------------------------------	------------------

**IX . UL CARD :**

OBMW2		January 7, 1988	
Component-Magnet Wire		E104048 (S)	
MITSUBISHI CABLE INDUSTRIES LTD			
4-3 IKEJIRI ITAMI , HYOGO 664 JAPAN			
Mtl	Coat Typ	ANSI	Temp
Dsg	BC	Oyercoat	Type
EDW-R52	Medis	Ester-imide	155

Marking : Company name and type designation on package or reels.

See General Information Preceding These Recognitions.

For use only in equipment where the acceptability of the combination is determined by Underwriters Laboratories Inc.

Report : January 5, 1988.

302279005	H7642	Underwriters Laboratories Inc.®	D11/0149909
-----------	-------	---------------------------------	-------------