

All rights reserved, Copyright Kradex 2016		
Product model	Enclosure Z39 - assembly	
Format: A3	Material: PS, ABS	
Scale 1:2	Tolerance: +/- 1,0	

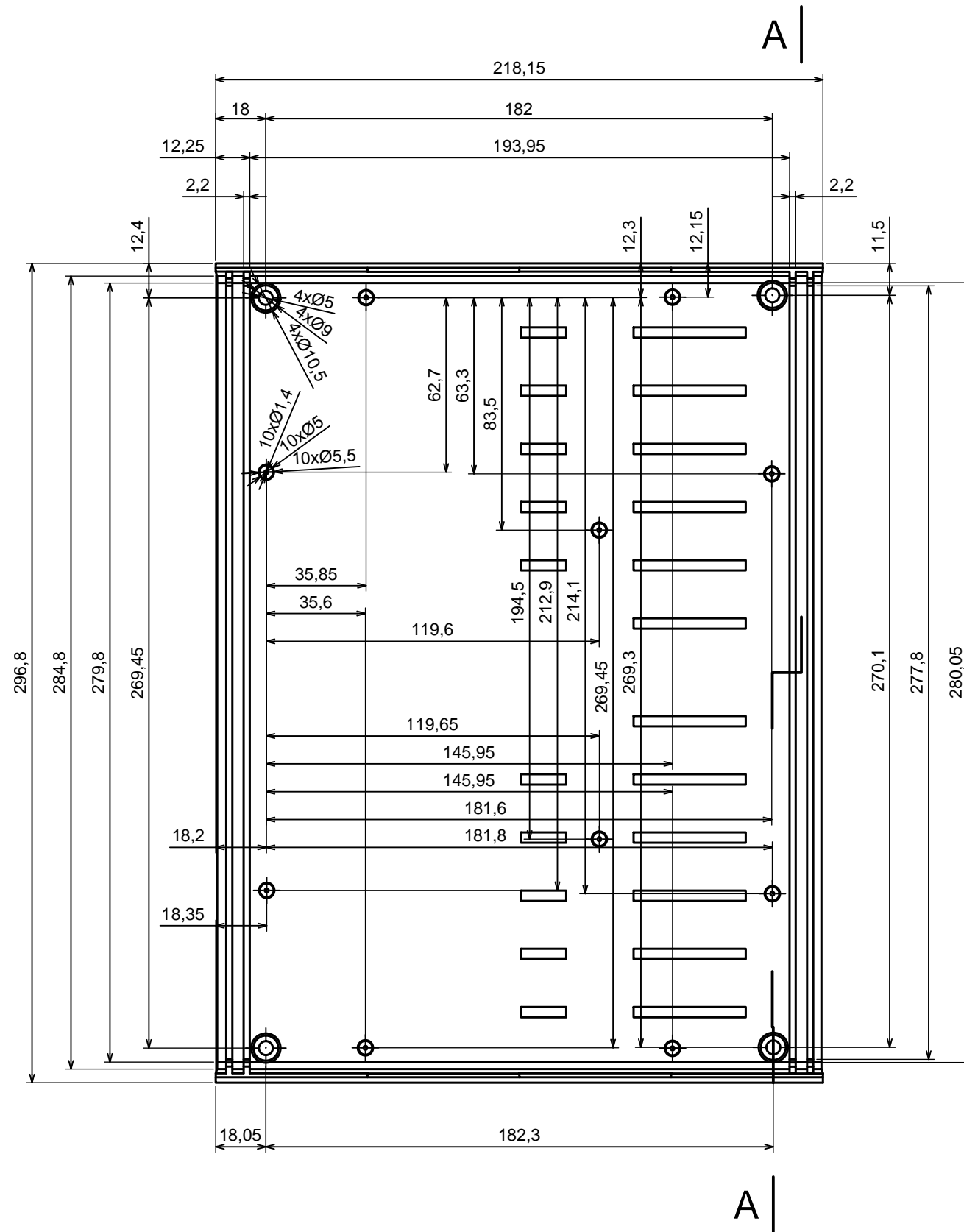

All rights reserved, Copyright Kradox 2016

Product model Enclosure Z39 - base

Format: A3 Material: PS, ABS

Scale 1:2 Tolerance: +/- 1,0



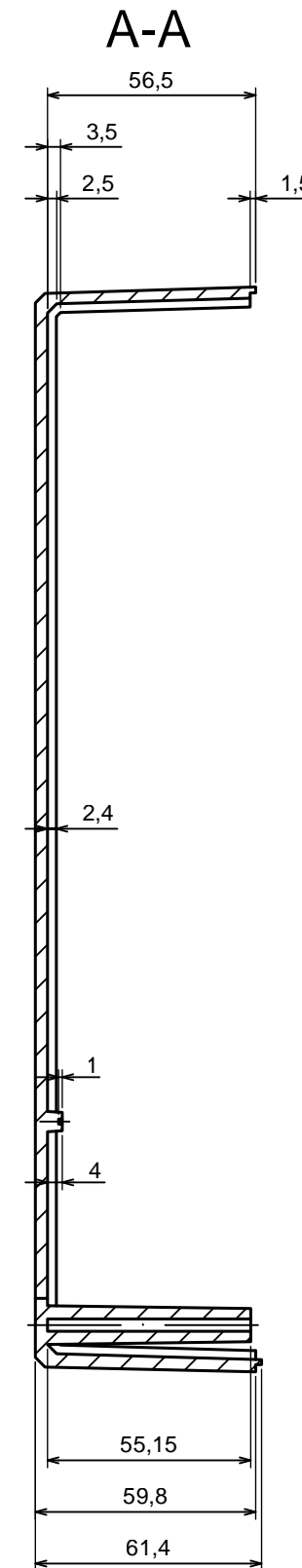
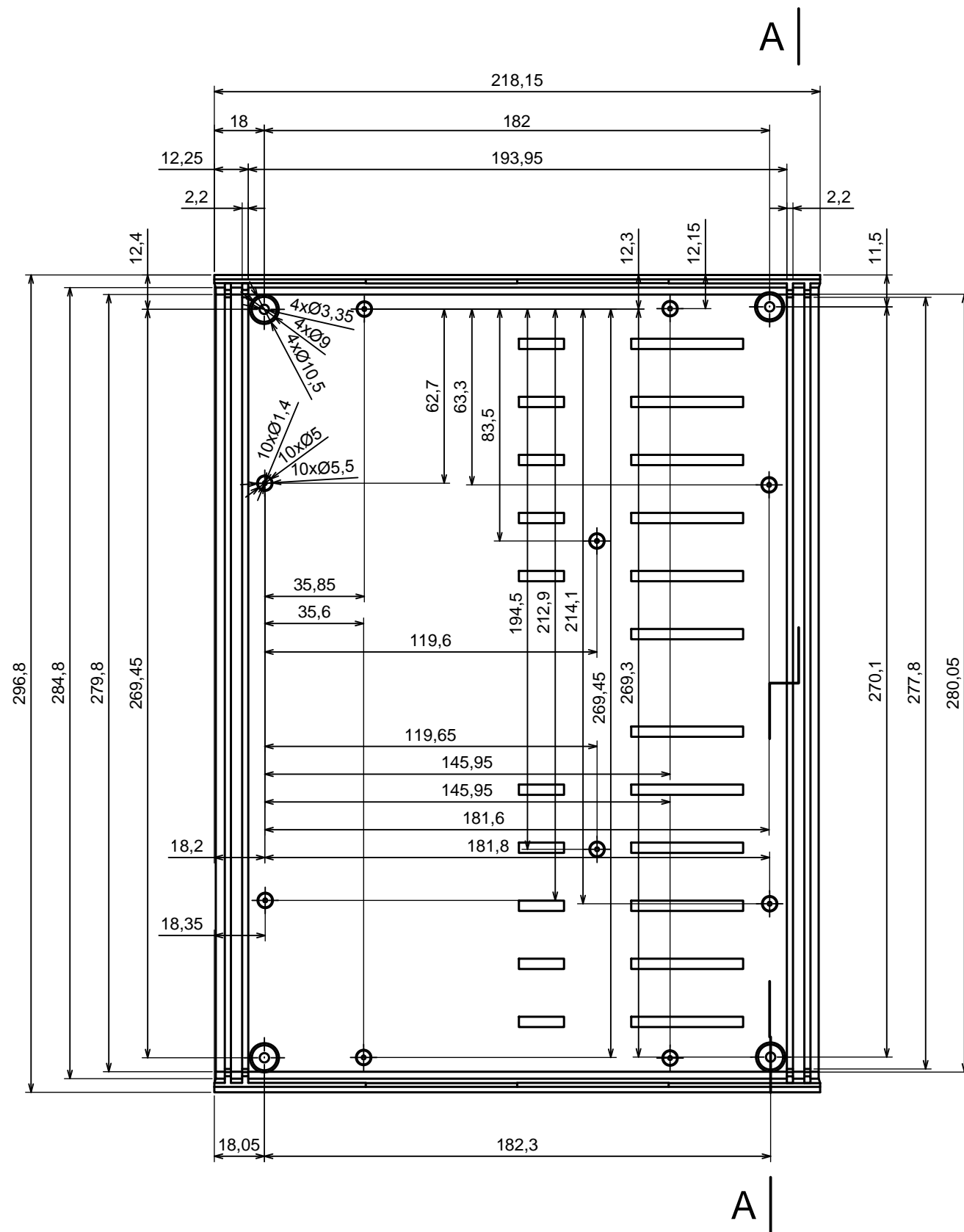

All rights reserved, Copyright Kradox 2016

Product model: Enclosure Z39 - cover

Format: A3 Material: PS, ABS

Scale 1:2 Tolerance: +/- 1,0



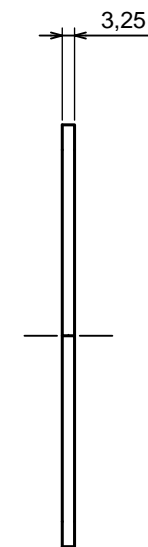
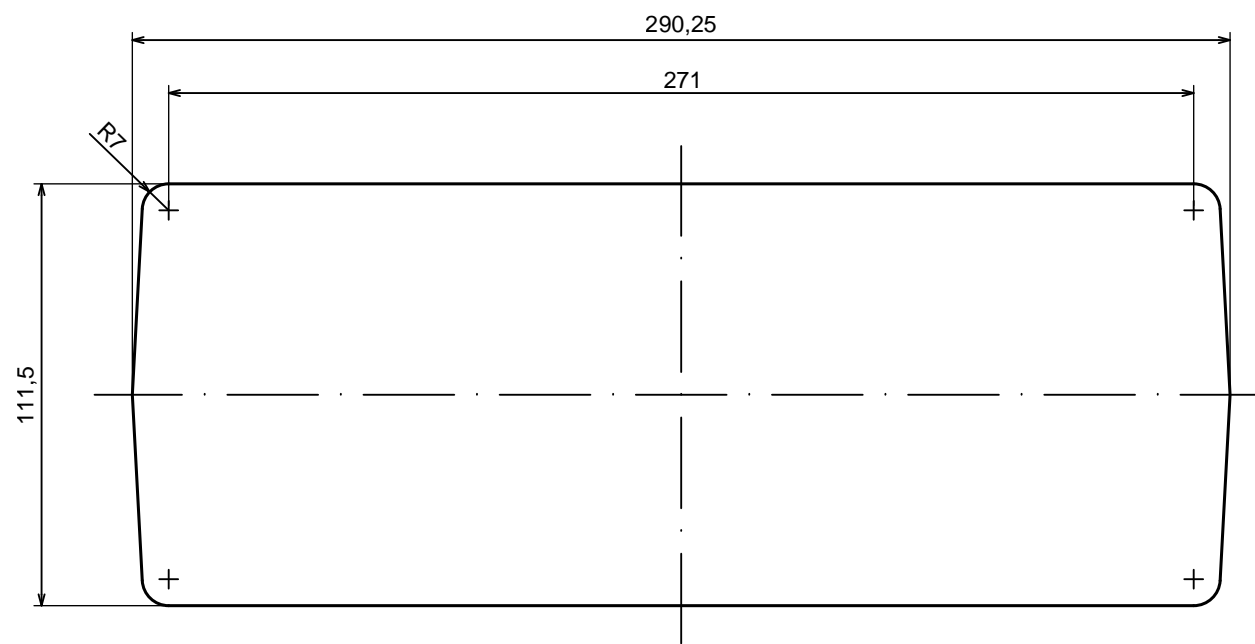

All rights reserved, Copyright Kradox 2016

Product model: Enclosure Z39 - board

Format: A3 Material: PS, ABS

Scale 1:2 Tolerance: +/- 1,0



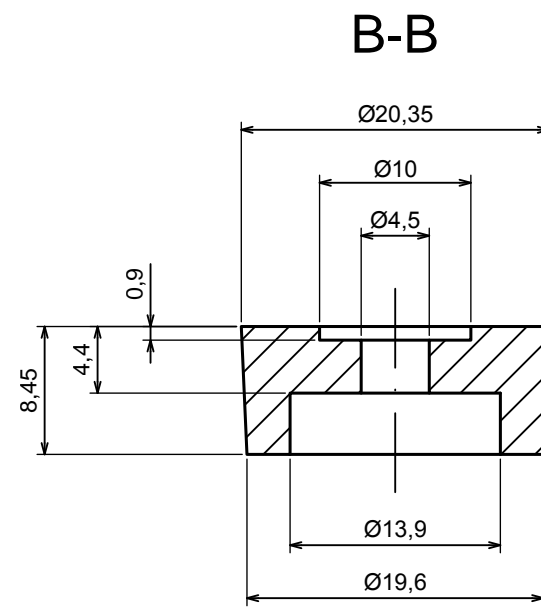

All rights reserved, Copyright Kradox 2016

Product model Enclosure Z39 - foot

Format: A3 Material: rubber

Scale 2:1 Tolerance: +/- 0.5

