

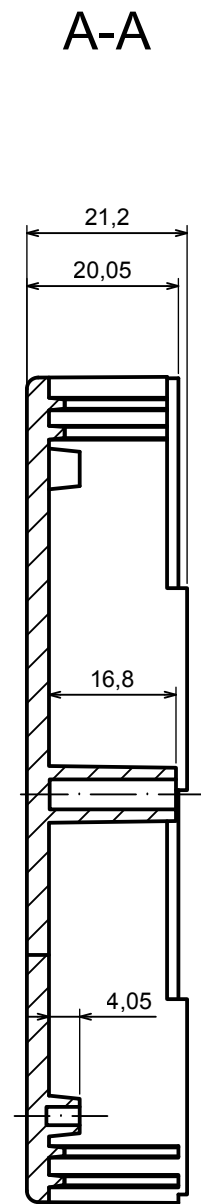

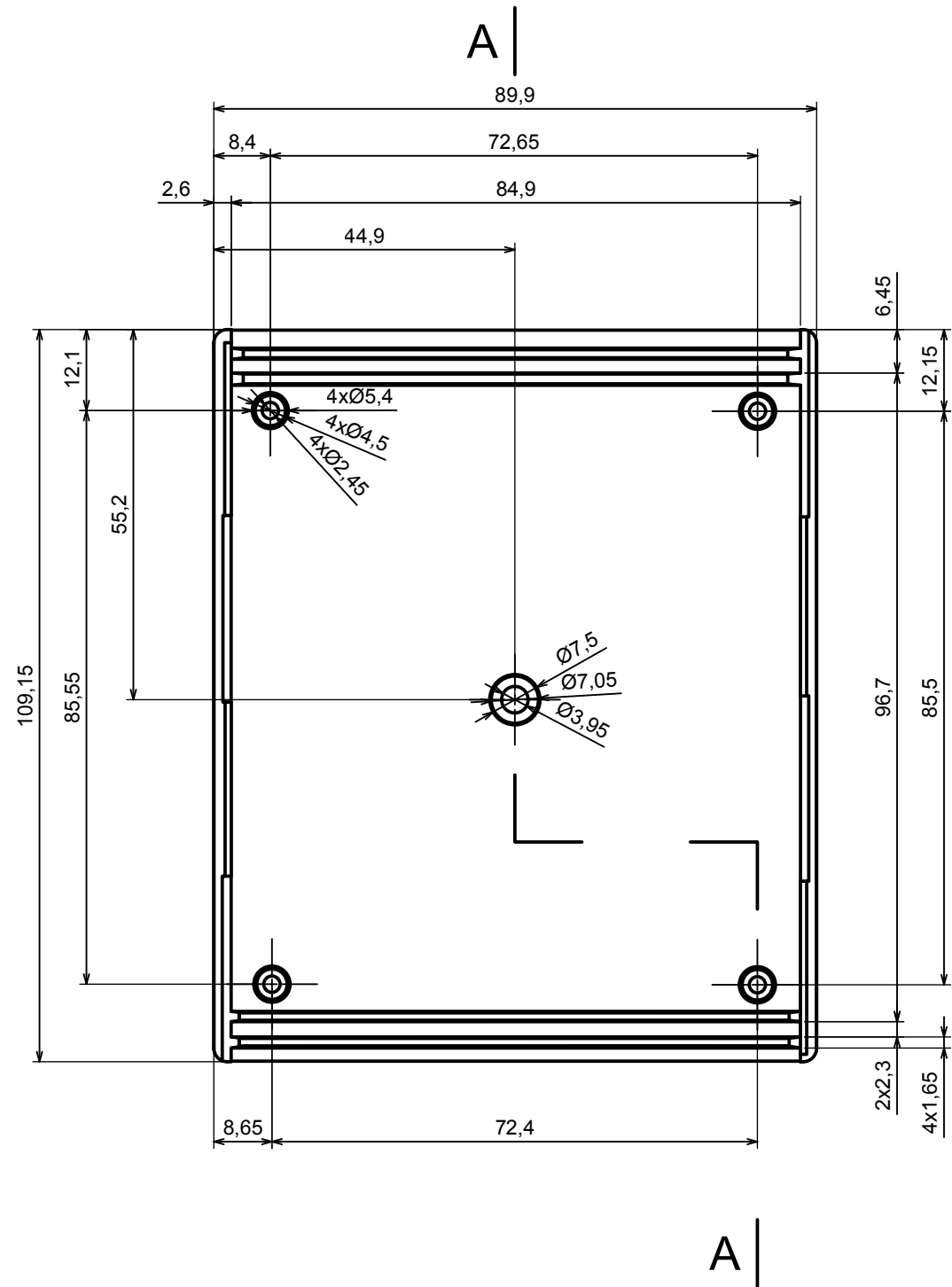

All rights reserved, Copyright Kradox 2017		
Product model	Enclosure Z5 - Assembly	
Format: A3	Material: PS, ABS	
Scale 1:1	Tolerance: +/- 0.8	



All rights reserved, Copyright Kradox 2017		
Product model	Enclosure Z5 - Base	
Format: A3	Material: PS, ABS	
Scale 1:1	Tolerance: +/- 0.8	

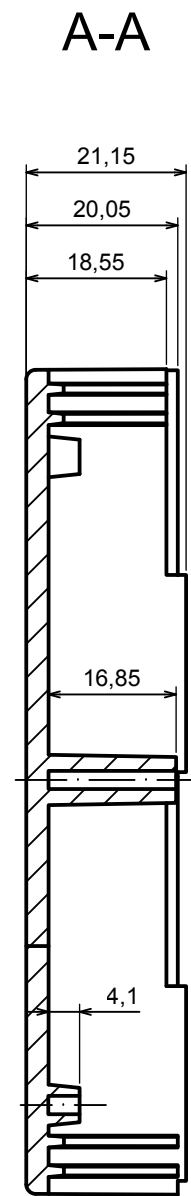
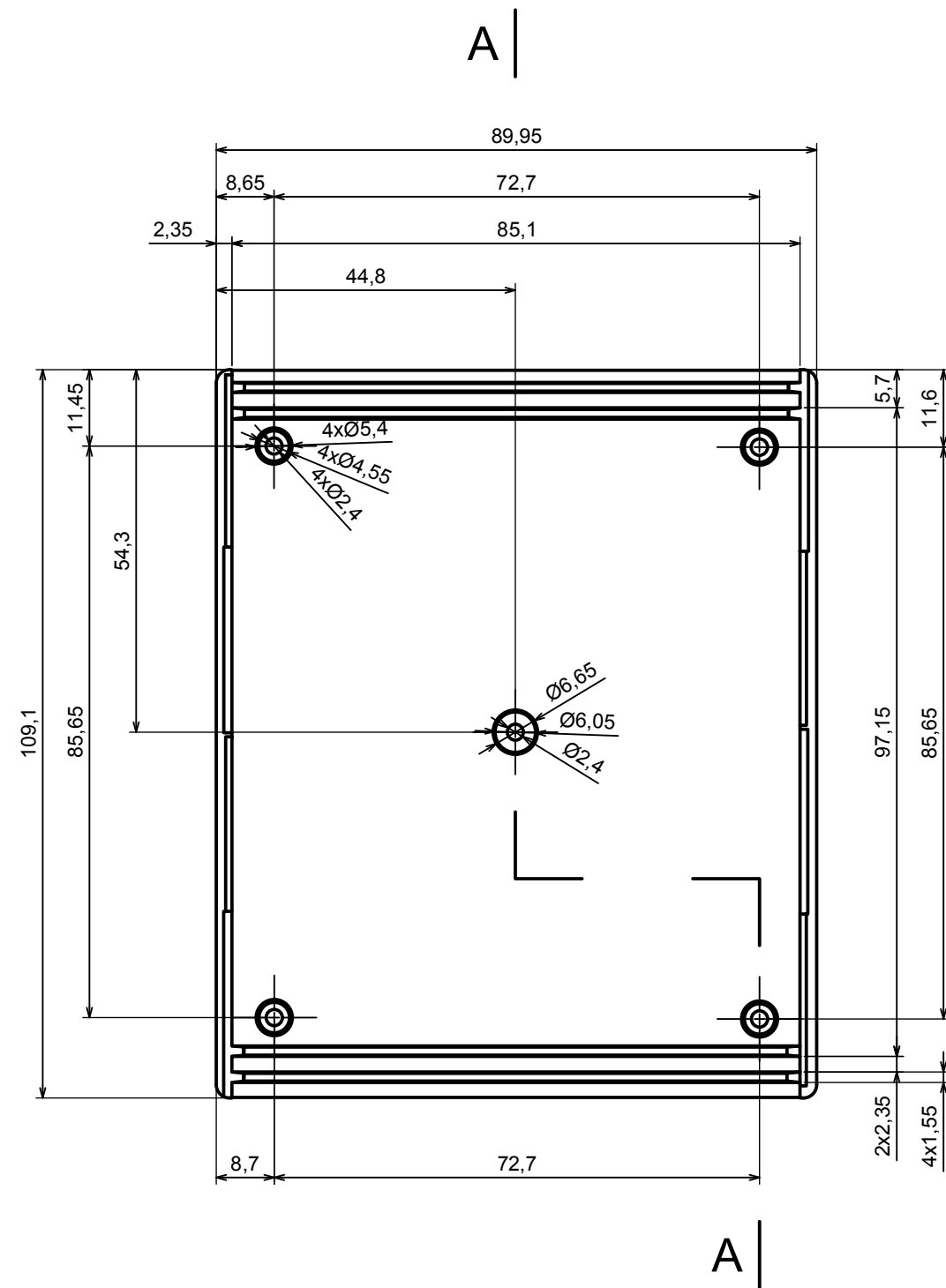

All rights reserved, Copyright Kradex 2017		
Product model	Enclosure Z5 - Cover	
Format: A3	Material: PS, ABS	
Scale 1:1	Tolerance: +/- 0.8	

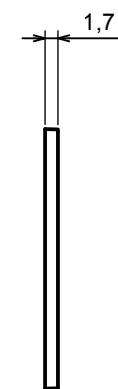
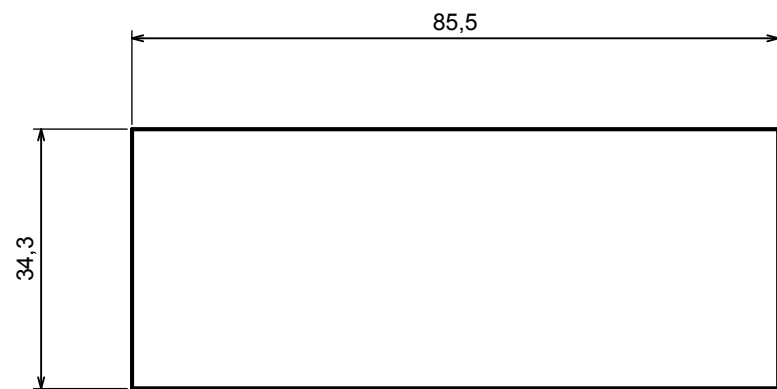

All rights reserved, Copyright Kradex 2017		
Product model	Enclosure Z5 - Board	
Format: A3	Material: PS, ABS	
Scale 1:1	Tolerance: +/- 0.8	