

All rights reserved, Copyright Kradex 2016		
Product model	Enclosure Z50A - assembly	
Format: A3	Material: PS, ABS	
Scale 1:1	Tolerance: +/- 0.8	

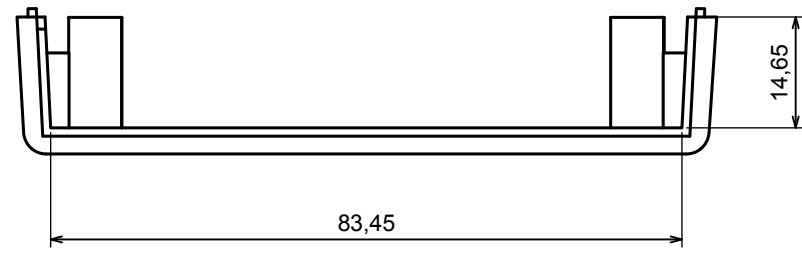

A |

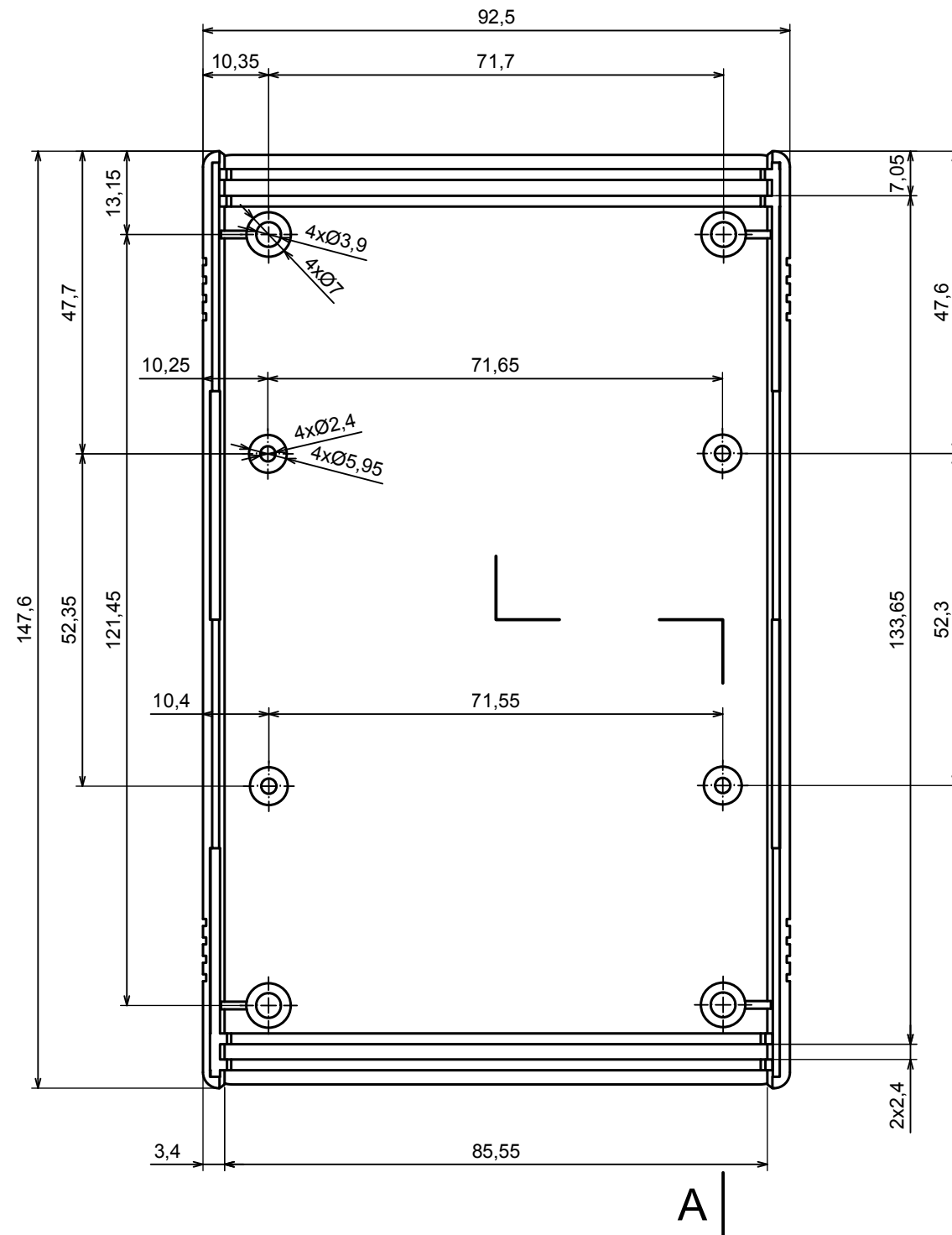

A-A

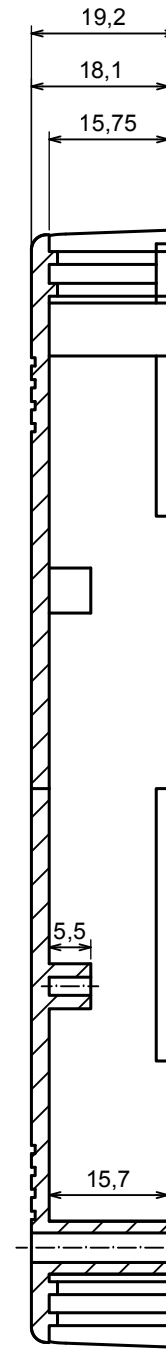

All rights reserved, Copyright Kradex 2016

Product model Enclosure Z50A - base

Format: A3 Material: PS, ABS

Scale 1:1 Tolerance: +/- 0.8



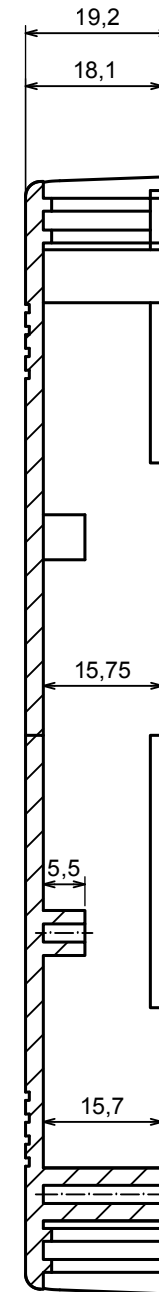
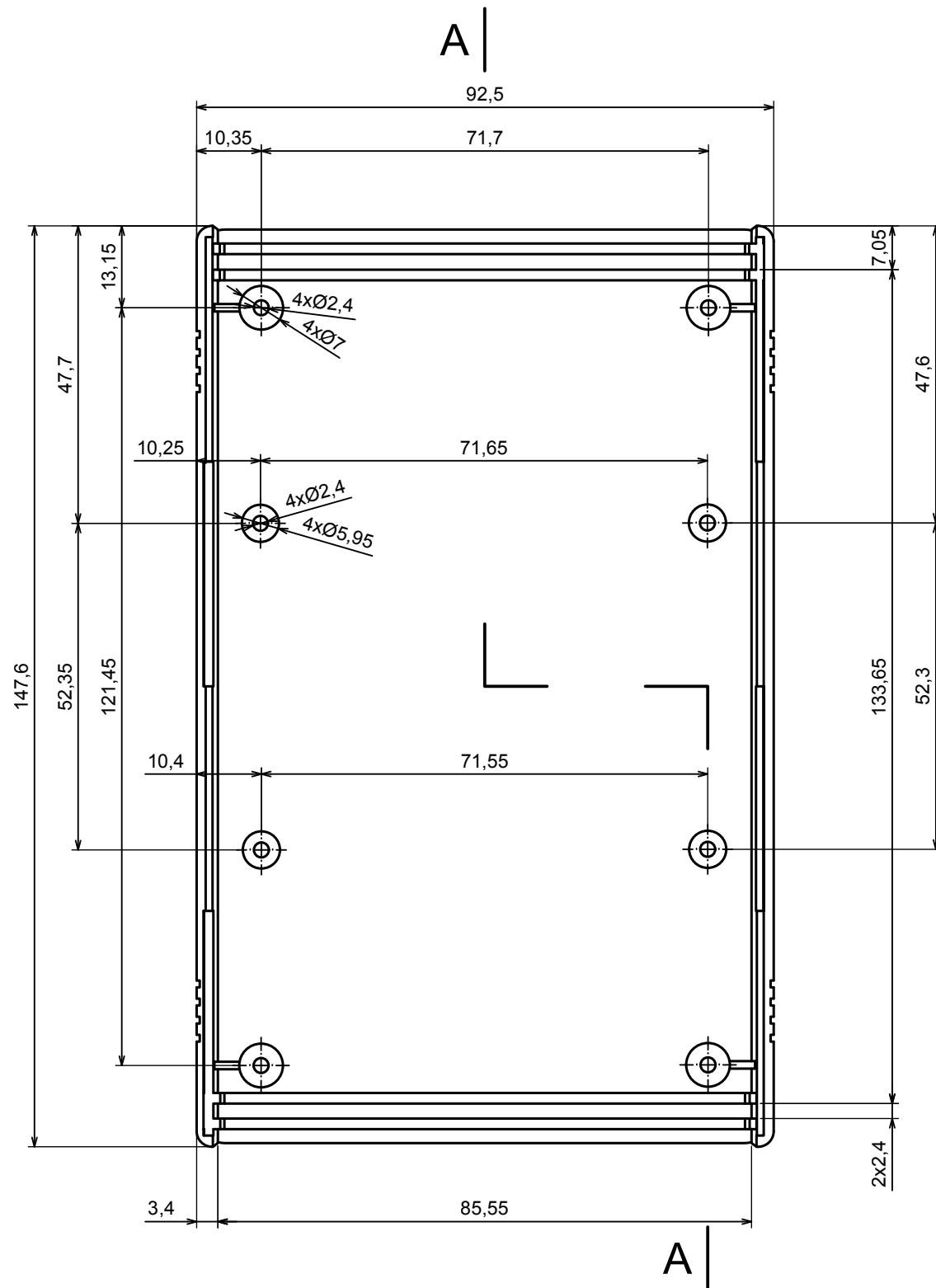
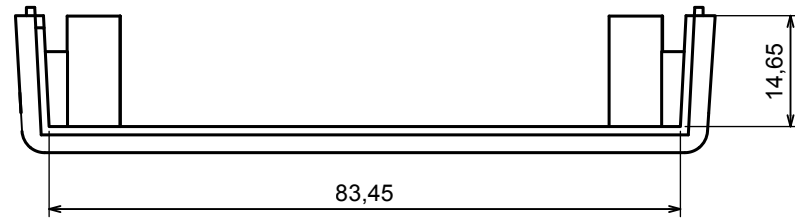

All rights reserved, Copyright Kradox 2016

Product model Enclosure Z50A - cover

Format: A3 Material: PS, ABS

Scale 1:1 Tolerance: +/- 0.8



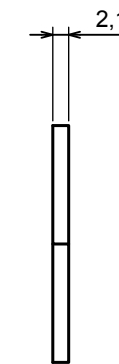
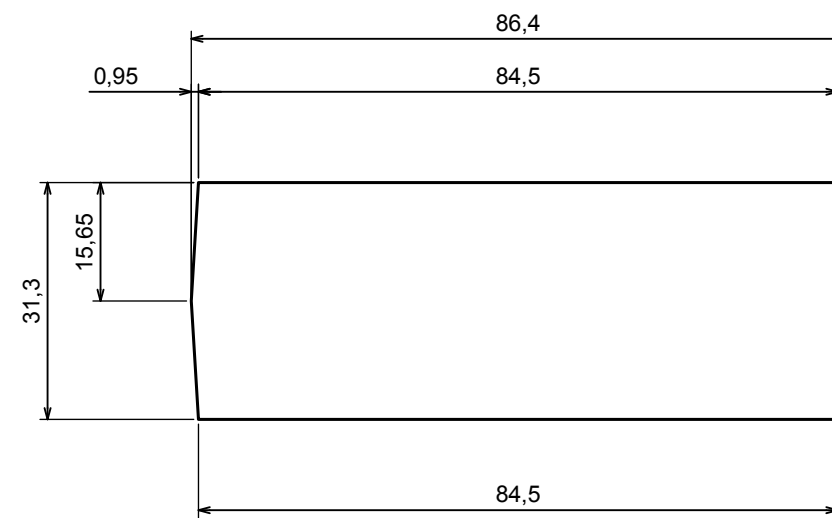

All rights reserved, Copyright Kradex 2016		
Product model	Enclosure Z50A - board	
Format: A3	Material: PS, ABS	
Scale 1:1	Tolerance: +/- 0.8	

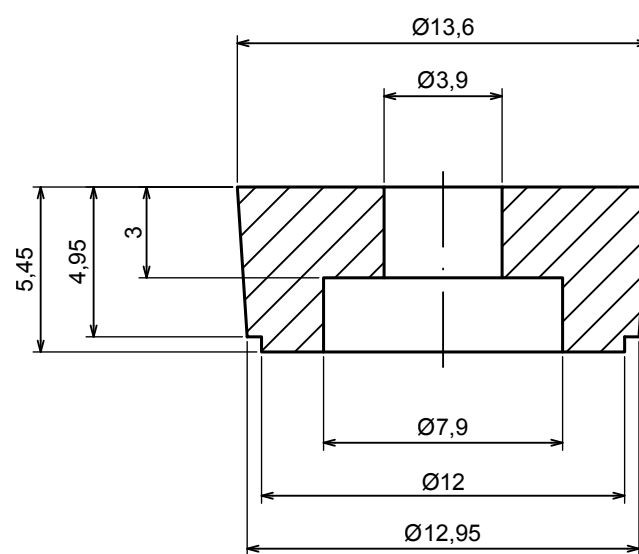

All rights reserved, Copyright Kradox 2016

Product model Enclosure Z50A - foot

Format: A3 Material: PS, ABS

Scale 4:1 Tolerance: +/- 0.5

