

All rights reserved, Copyright Kradox 2017		
Product model	Enclosure Z51U - Assembly	
Format: A3	Material: PS, ABS	
Scale 1:1	Tolerance: +/- 0.6	

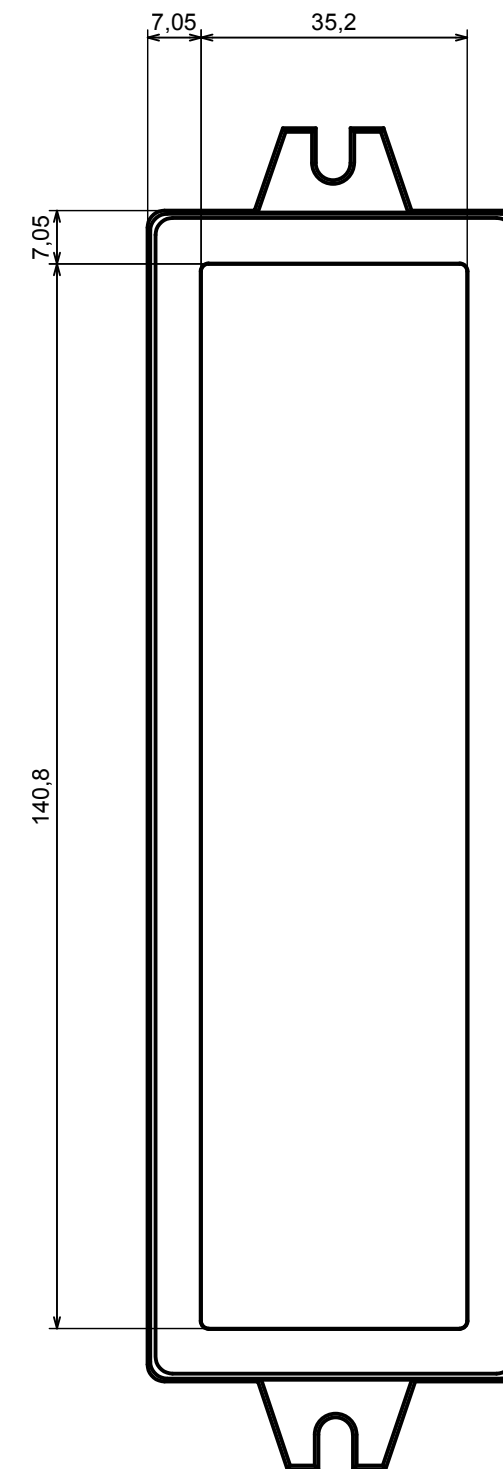
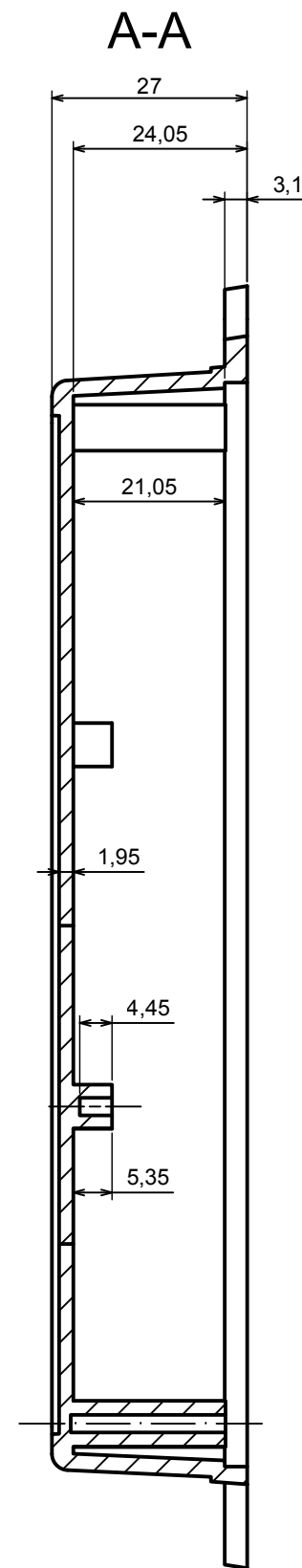
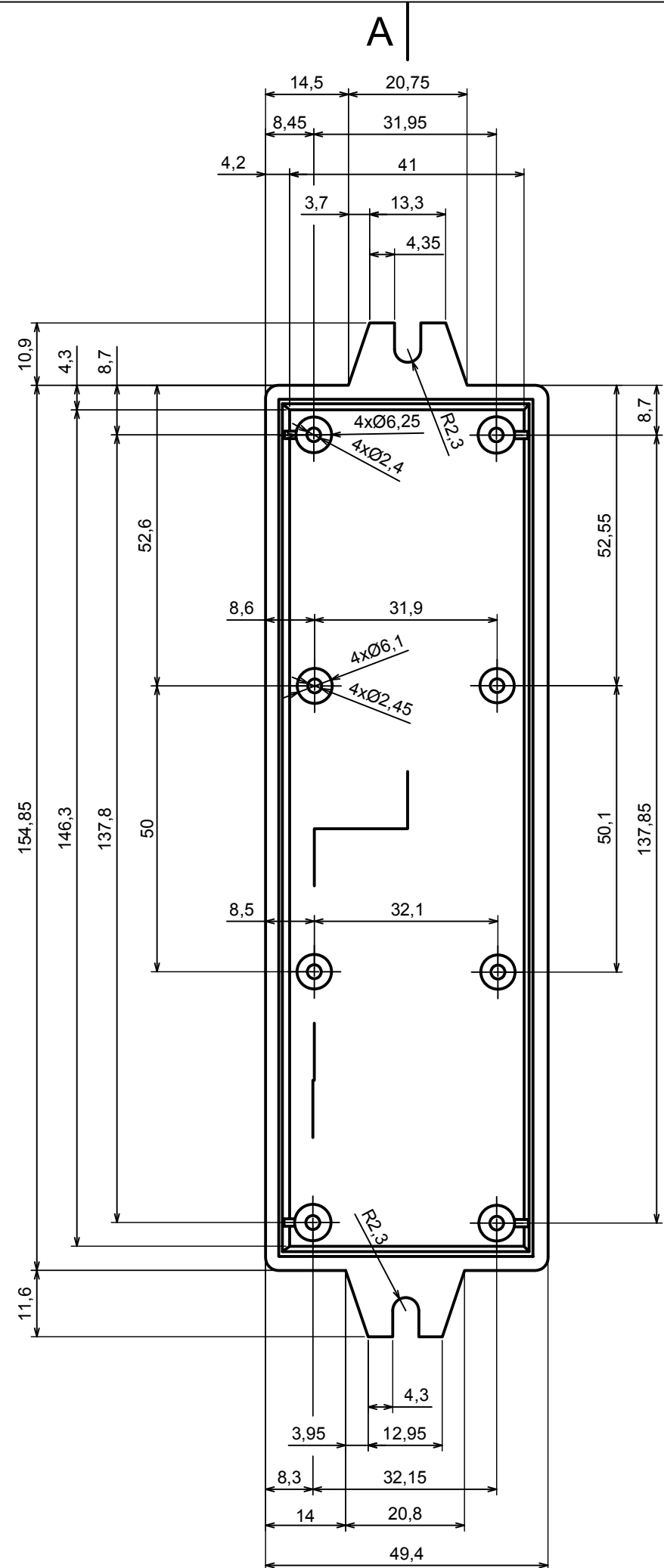

All rights reserved, Copyright Kradox 2017

Product model: Enclosure Z51U - Base

Format: A3 | Material: PS, ABS

Scale 1:1 | Tolerance: +/- 0.6



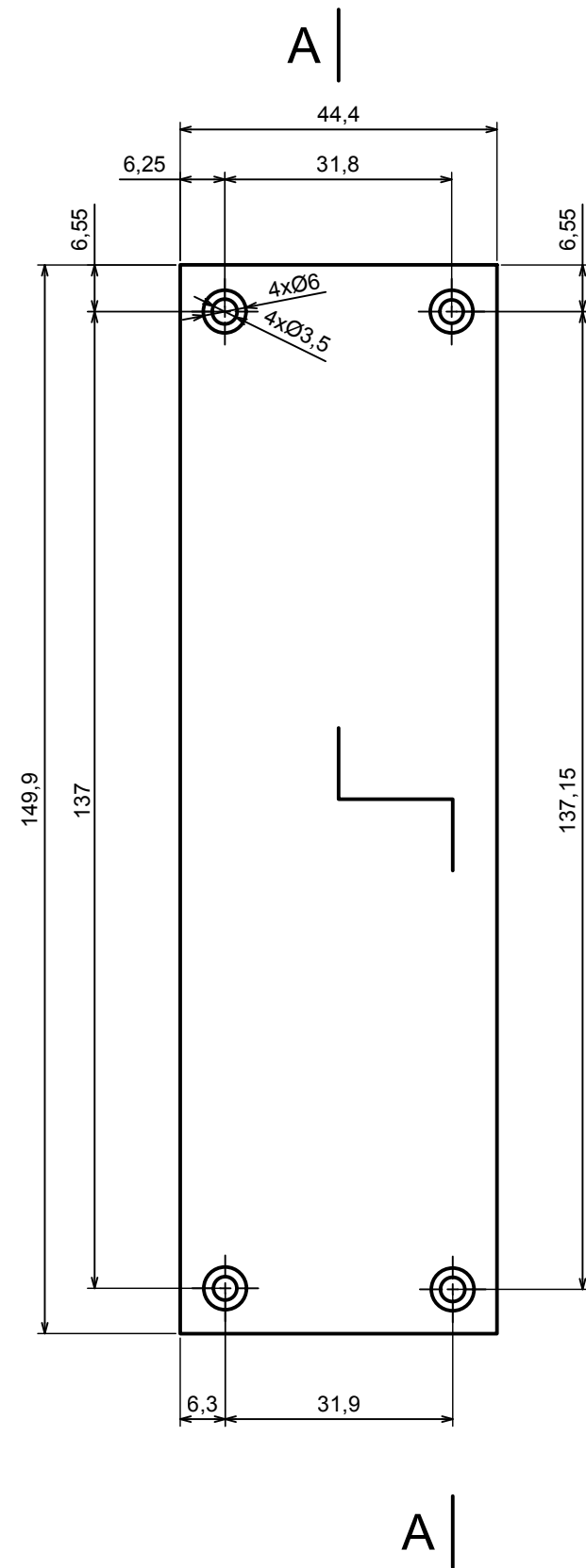

A-A

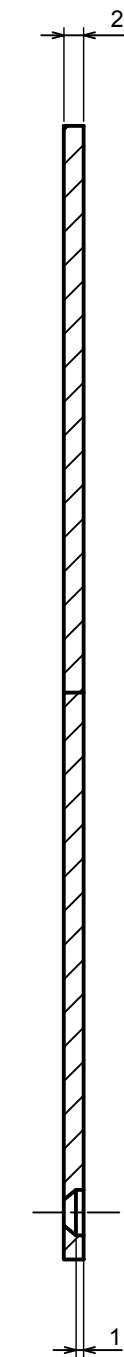

All rights reserved, Copyright Kradox 2017		
Product model	Enclosure Z51U - Cover	
Format: A3	Material: PS, ABS	
Scale 1:1	Tolerance: +/- 0.6	