

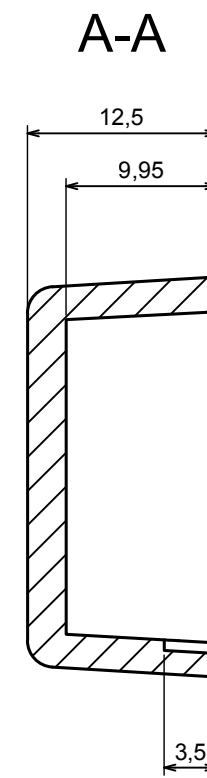

All rights reserved, Copyright Kradex 2017		
Product model	Enclosure Z63 - Assembly	
Format: A3	Material: PS, ABS	
Scale 2:1	Tolerance: +/- 0.5	

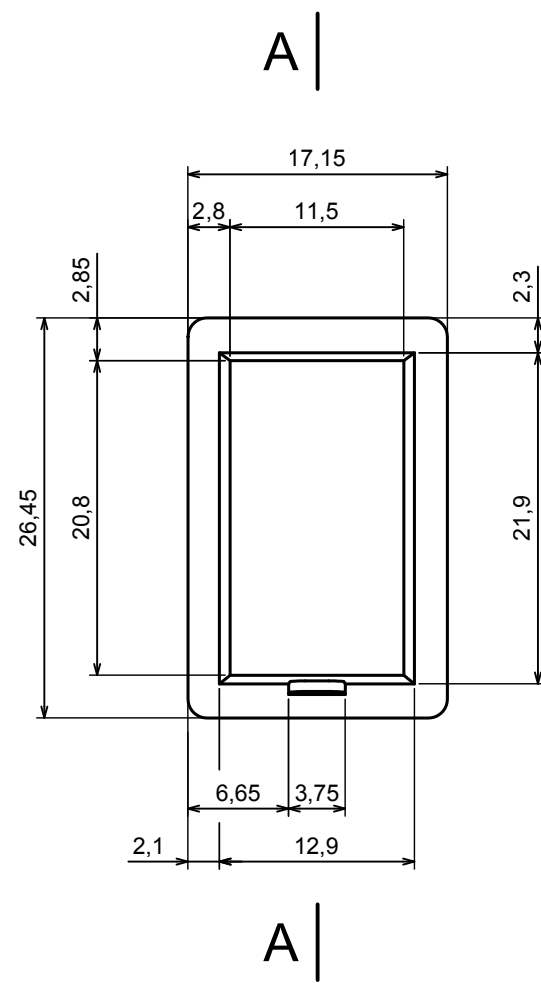

All rights reserved, Copyright Kradex 2017		
Product model	Enclosure Z63 - Base	
Format: A3	Material: PS, ABS	
Scale 2:1	Tolerance: +/- 0.5	

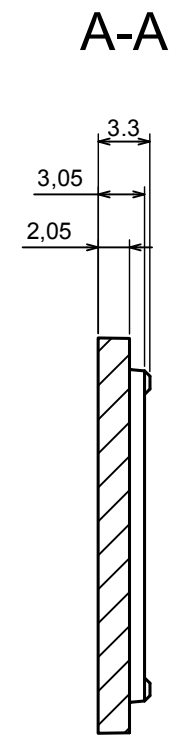
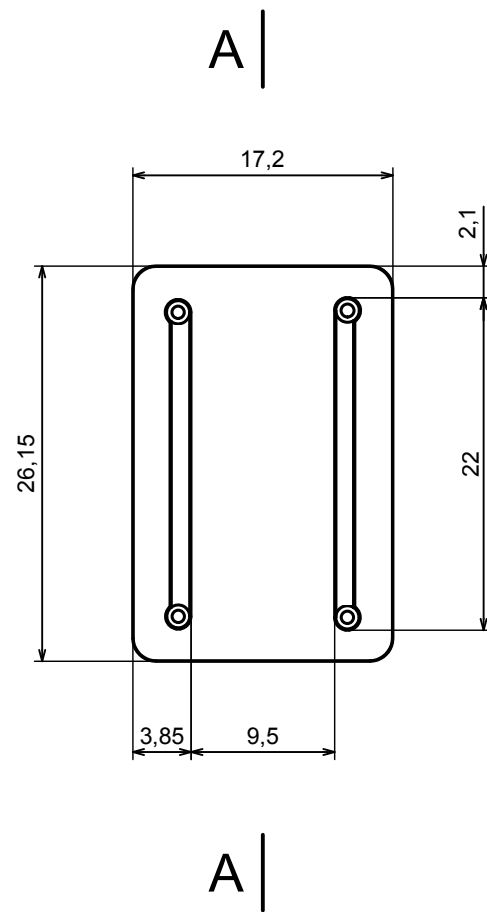

All rights reserved, Copyright Kradex 2017		
Product model	Enclosure Z63 - Cover	
Format: A3	Material: PS, ABS	
Scale 2:1	Tolerance: +/- 0.5	