

PRODUCT SPECIFICATION

Model No.: FYL-5016LRD1C-B

Descriptions:
<ul style="list-style-type: none"> ■ Dice material: AlGaInP. ■ Emitting Color: Bright Red. ■ Device Outline: Φ5mm round blinking flash type. ■ Lens Type: Red Diffused.



CUSTOMER APPROVED SIGNATURES	APPROVED BY	CHECKED BY	PREPARED BY

NINGBO FORYARD OPTOELECTRONICS CO.,LTD.

Add:No. 666 Jinghua Road, Hi-tech Park, Ningbo, Zhejiang, China

Zip:315103

Tel: 0086-574-87933652 87922206 87927870

Fax: 0086-574-87927917

E-mail:Sales@foryard.com (General)

Model No.: FYL-5016LRD1C-B

■ Features

- 1.Low power consumption.
- 2.High efficiency.
- 3.General purpose leads.
- 4.High intensity.
- 5.RoHs compliant.

■ Package configuration

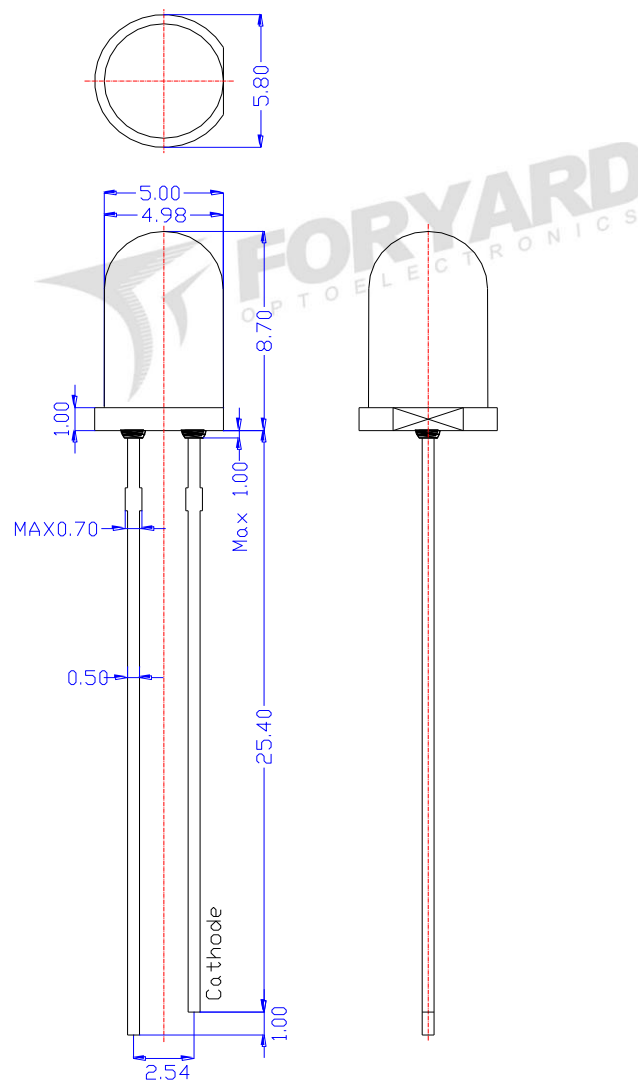

Notes:

1. All dimensions are millimeters (inches)
2. Tolerance is $\pm 0.25\text{mm}(.010\text{'})$ unless otherwise noted.
3. The specifications, characteristics and technical data described in the datasheet are subject to change without prior notice.
- 4.The drawing is different from the actual one, please refer to the sample.

Model No.: FYL-5016LRD1C-B

■ Absolute Maximum Ratings(Ta=25°C)

Parameter	MAX.	Unit
Power Dissipation	75	mW
Peak Forward Current (1/10 Duty Cycle, 0.1ms Pulse Width)	100	mA
Continuous Forward Current	30	mA
Derating Linear From 50°C	0.4	mA/°C
Reverse Voltage	5	V
Operating Temperature Range	-40°C to +85°C	
Storage Temperature Range	-40°C to +100°C	
Lead Soldering Temperature[4mm(.157") From Body]	260°C for 5 Seconds	

■ Typical Electrical & Optical Characteristics(Ta=25°C)

Parameter	Symbol	Min.	Typ.	Max.	Unit	Test Condition
Luminous Intensity	I_V	150	350	700	mcd	IF=20mA
Viewing Angle	$2\theta_{1/2}$	---	30	---	Deg	
Peak Emission Wavelength	λ_p	---	640	--	nm	
Dominant Wavelength	λ_d	630	635	640	nm	
Spectral Line Half-Width	$\Delta\lambda$	---	20	--	nm	
Forward Voltage	V_F	5	7	--	V	
Blinking Frequency	Fblk	2	2.4	2.8	Hz	VDD=5V
Reverse Current	I_R	---	---	10	μ A	VR=5V

Note:

- 1.Luminous Intensity is based on the Foryard standards.
- 2.Pay attention about static for InGaN

Model No.: FYL-5016LRD1C-B

Typical Eletrical/Optical Characteristics Curves(Ta=25°C Unless Otherwise Noted)

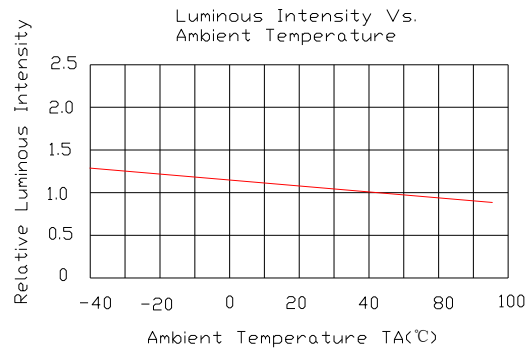
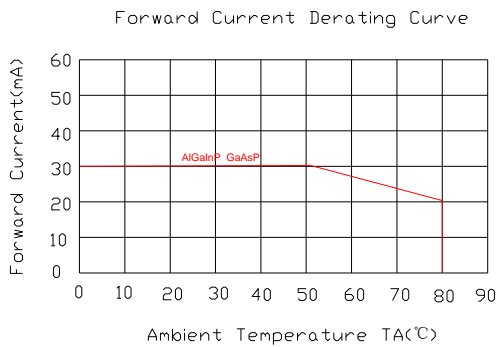
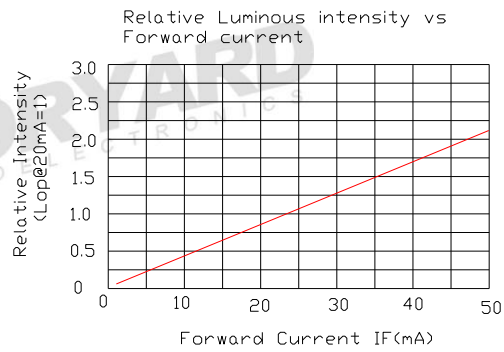
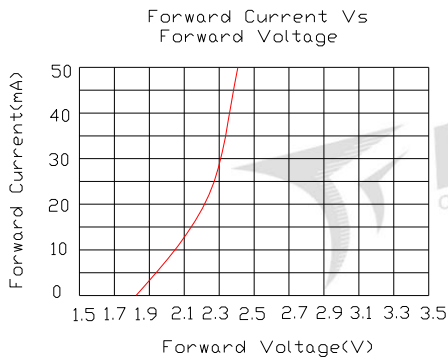
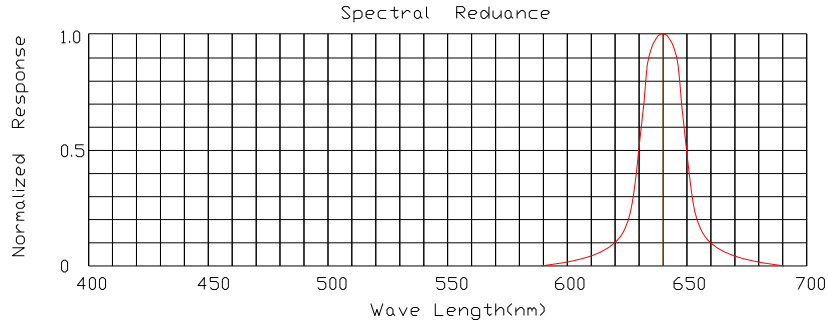

Radiation pattern

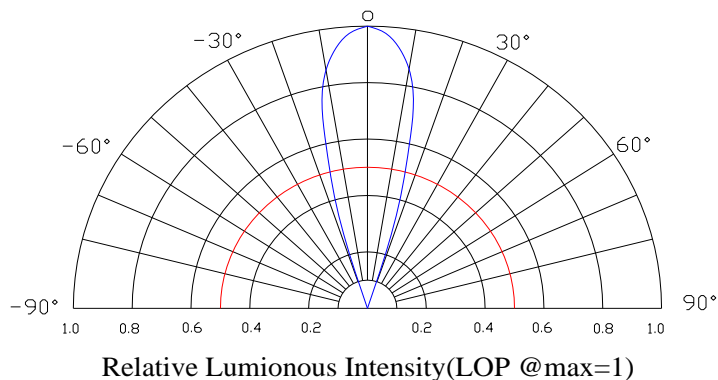

Model No.: FYL-5016LRD1C-B

■ LAMP PACKING.

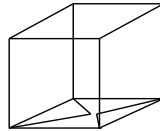
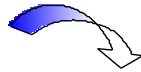
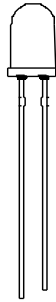

5mm 1000PCS/Polybag

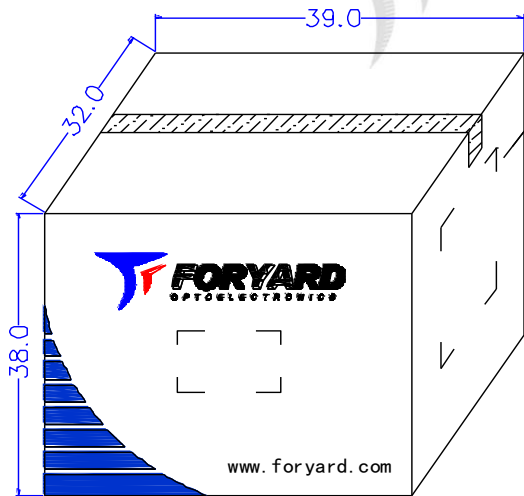

48000PCS/Carton

OUTSIDE LABEL

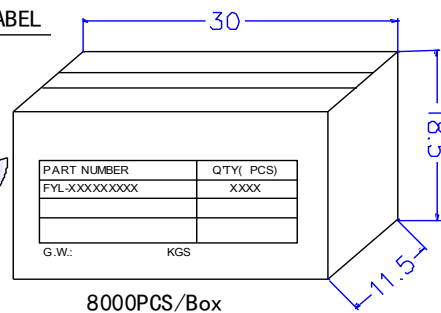

8000PCS/Box

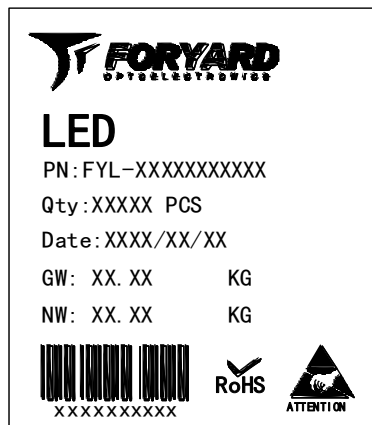

OUTSIDE LABEL

Note: The specifications are subject to change without notice. Please contact us for updated information.