

# PRODUCT SPECIFICATION

**Model No.: FYL-5016YD1C-B**

Descriptions:
<ul style="list-style-type: none"> <li>■ Dice material: GaAsP.</li> <li>■ Emitting Color: Yellow.</li> <li>■ Device Outline: Φ5mm round blinking flash type.</li> <li>■ Lens Type: Yellow Diffused.</li> </ul>



CUSTOMER APPROVED SIGNATURES	APPROVED BY	CHECKED BY	PREPARED BY

**NINGBO FORYARD OPTOELECTRONICS CO.,LTD.**

**Add:**No. 666 Jinghua Road, Hi-tech Park, Ningbo, Zhejiang, China

**Zip:**315103

**Tel:** 0086-574-87933652 87922206 87927870

**Fax:** 0086-574-87927917

**E-mail:**Sales@foryard.com (General)

**Model No.: FYL-5016YD1C-B**

**■ Features**

- 1.Low power consumption.
- 2.High efficiency.
- 3.General purpose leads.
- 4.High intensity.
- 5.RoHs compliant.

**■ Package configuration**

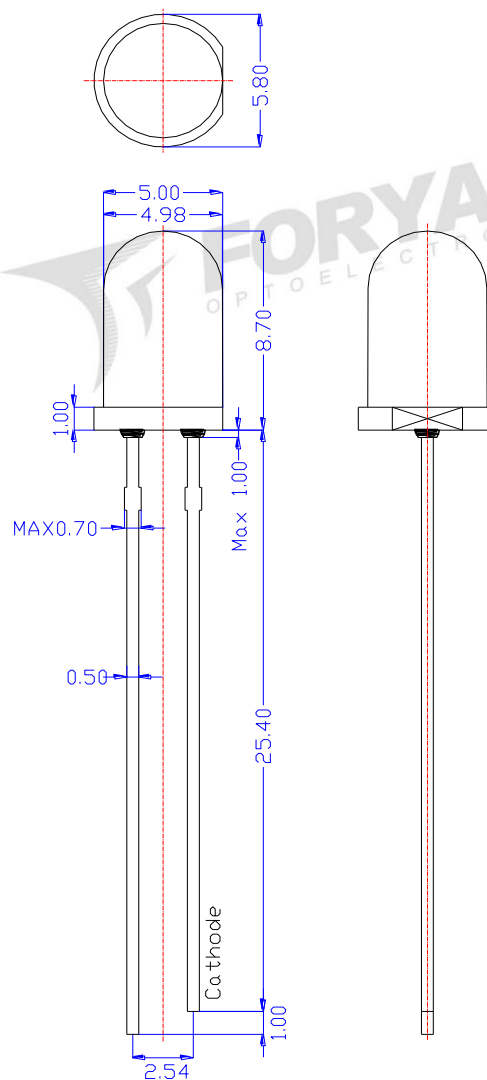

**Notes:**

1. All dimensions are millimeters (inches)
2. Tolerance is  $\pm 0.25\text{mm} (.010\text{'})$  unless otherwise noted.
3. The specifications, characteristics and technical data described in the datasheet are subject to change without prior notice.
- 4.The drawing is different from the actual one, please refer to the sample.

Model No.: FYL-5016YD1C-B

### ■ Absolute Maximum Ratings(Ta=25°C)

Parameter	MAX.	Unit
Power Dissipation	80	mW
Peak Forward Current (1/10 Duty Cycle, 0.1ms Pulse Width)	150	mA
Continuous Forward Current	30	mA
Derating Linear From 50°C	0.4	mA/°C
Reverse Voltage	5	V
Operating Temperature Range	-40°C to +85°C	
Storage Temperature Range	-40°C to +100°C	
Lead Soldering Temperature[4mm(.157") From Body]	260°C for 5 Seconds	

### ■ Typical Electrical & Optical Characteristics(Ta=25°C)

Parameter	Symbol	Min.	Typ.	Max.	Unit	Test Condition
Luminous Intensity	$I_V$	14	30	70	mcd	IF=20mA
Viewing Angle	$2\theta_{1/2}$	---	30	---	Deg	
Peak Emission Wavelength	$\lambda_p$	---	590	--	nm	
Dominant Wavelength	$\lambda_d$	585	590	595	nm	
Spectral Line Half-Width	$\Delta\lambda$	---	35	--	nm	
Forward Voltage	$V_F$	5	7	--	V	
Blinking Frequency	Fblk	2	2.4	2.8	Hz	VDD=5V
Reverse Current	$I_R$	---	---	10	$\mu A$	VR=5V

Note:

- 1.Luminous Intensity is based on the Foryard standards.
- 2.Pay attention about static for InGaN

**Model No.: FYL-5016YD1C-B**

**Typical Eletrical/Optical Characteristics Curves(Ta=25°C Unless Otherwise Noted)**

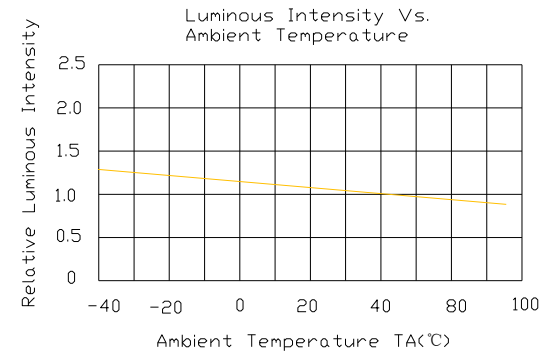
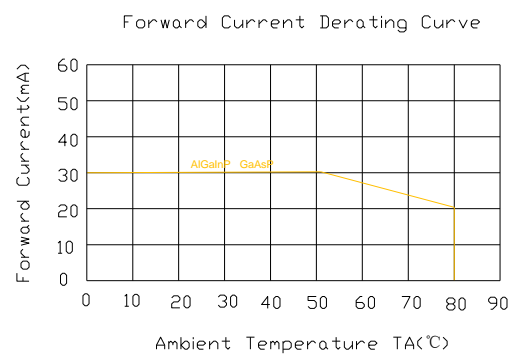
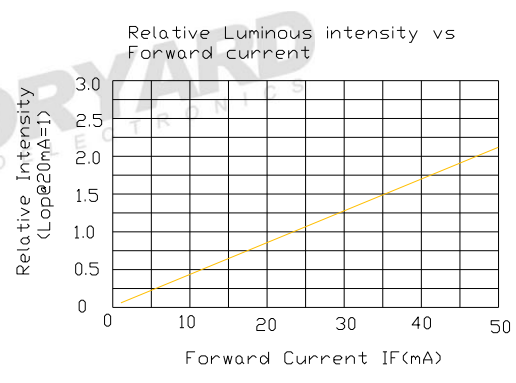
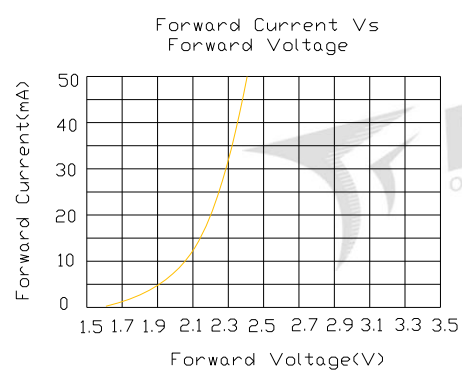
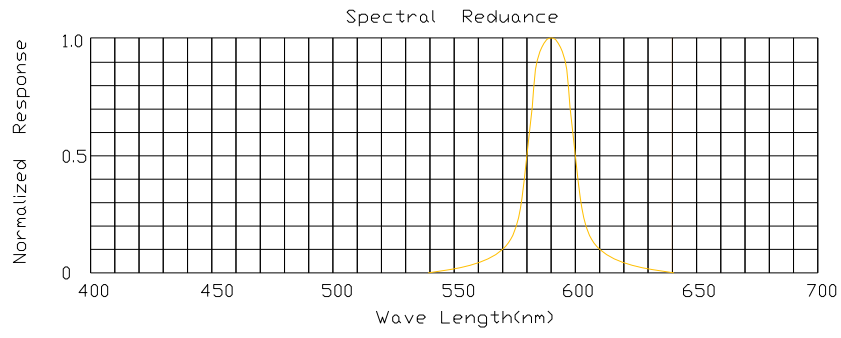

**Radiation pattern**

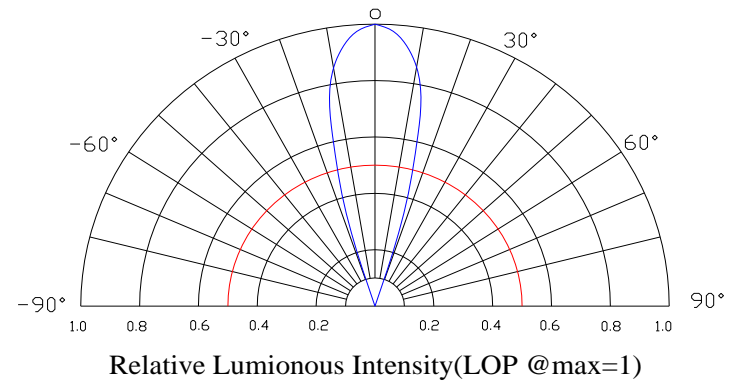

**Model No.: FYL-5016YD1C-B**

**■ LAMP PACKING.**

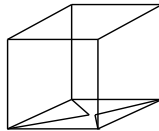
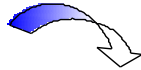
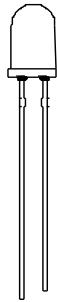

5mm 1000PCS/Polybag

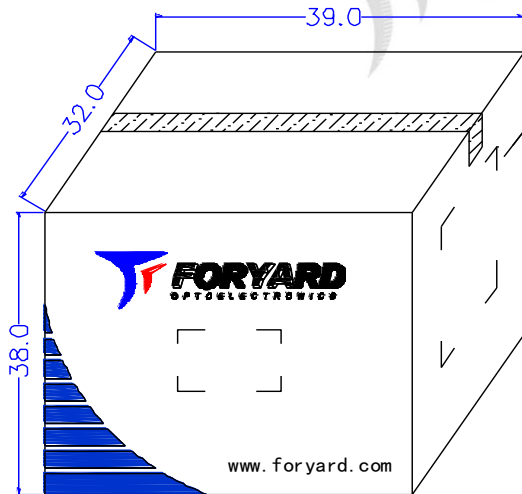

48000PCS/Carton

OUTSIDE LABEL

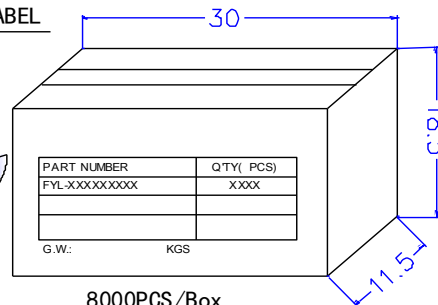

8000PCS/Box

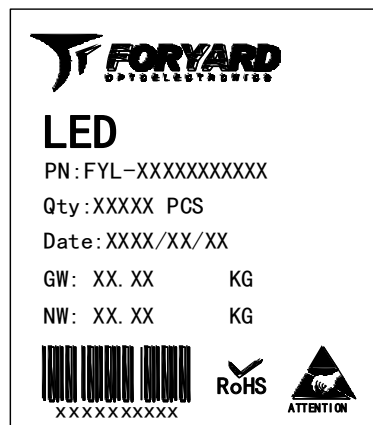

OUTSIDE LABEL

Note: The specifications are subject to change without notice. Please contact us for updated information.