

# PRODUCT SPECIFICATION

**Model No.: FYL-8013UBC1B**

Descriptions:
<ul style="list-style-type: none"> <li>■ Dice material: InGaN.</li> <li>■ Emitting Color: Super Bright Blue.</li> <li>■ Device Outline: Φ8mm round type.</li> <li>■ Lens Type: Water clear.</li> </ul>



CUSTOMER APPROVED SIGNATURES	APPROVED BY	CHECKED BY	PREPARED BY

**NINGBO FORYARD OPTOELECTRONICS CO.,LTD.**

**Add:**No. 666 Jinghua Road, Hi-tech Park, Ningbo, Zhejiang, China

**Zip:**315103

**Tel:** 0086-574-87933652 87922206 87927870

**Fax:** 0086-574-87927917

**E-mail:**Sales@foryard.com (General)

**Model No.: FYL-8013UBC1B**

**■ Features**

- 1.Low power consumption.
- 2.High efficiency.
- 3.General purpose leads.
- 4.High intensity.
- 5.RoHs compliant.

**■ Package configuration**

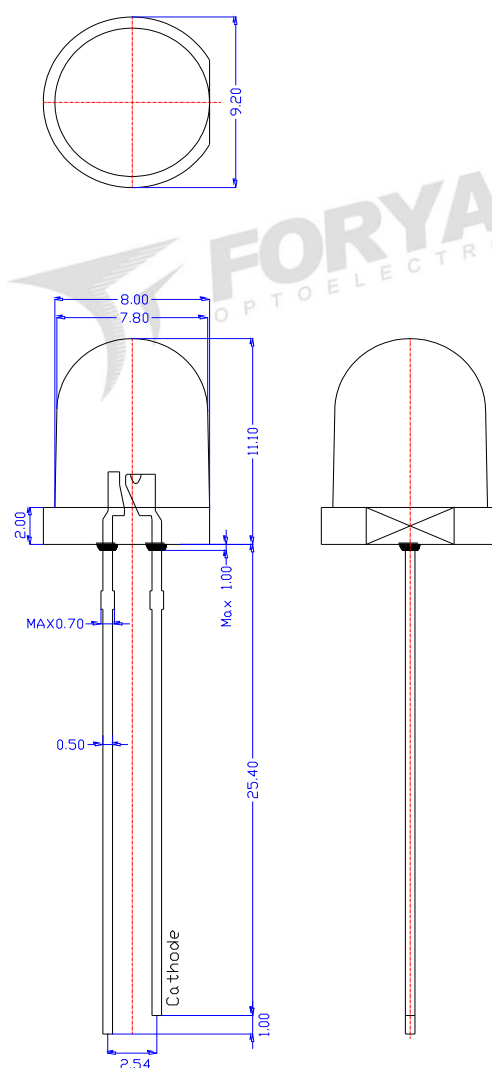

**Notes:**

1. All dimensions are millimeters (inches)
2. Tolerance is  $\pm 0.25\text{mm}$  (.010") unless otherwise noted.
3. The specifications, characteristics and technical data described in the datasheet are subject to change without prior notice.
4. The drawing is different from the actual one, please refer to the sample.

Model No.: FYL-8013UBC1B

■ Absolute Maximum Ratings(Ta=25°C)

Parameter	MAX.	Unit
Power Dissipation	100	mW
Peak Forward Current (1/10 Duty Cycle, 0.1ms Pulse Width)	100	mA
Continuous Forward Current	30	mA
Derating Linear From 50°C	0.4	mA/°C
Reverse Voltage	5	V
Operating Temperature Range	-40°C to +85°C	
Storage Temperature Range	-40°C to +100°C	
Lead Soldering Temperature[4mm(.157") From Body]	260°C for 5 Seconds	

■ Typical Electrical & Optical Characteristics(Ta=25°C)

Parameter	Symbol	Min.	Typ.	Max.	Unit	Test Condition
Luminous Intensity	$I_v$	4750	7500	10800	mcd	IF=20mA
Viewing Angle	$2\theta_{1/2}$	---	15	---	Deg	
Peak Emission Wavelength	$\lambda_p$	---	470	--	nm	
Dominant Wavelength	$\lambda_d$	461	467	473	nm	
Spectral Line Half-Width	$\Delta\lambda$	---	30	--	nm	
Forward Voltage	$V_F$	2.6	3	3.4	V	VR=5V
Reverse Current	$I_R$	---	---	10	$\mu A$	

Note:

- 1.Luminous Intensity is based on the Foryard standards.
- 2.Pay attention about static for InGaN

Model No.: FYL-8013UBC1B

■ Typical Eletrical/Optical Characteristics Curves(Ta=25°C Unless Otherwise Noted)

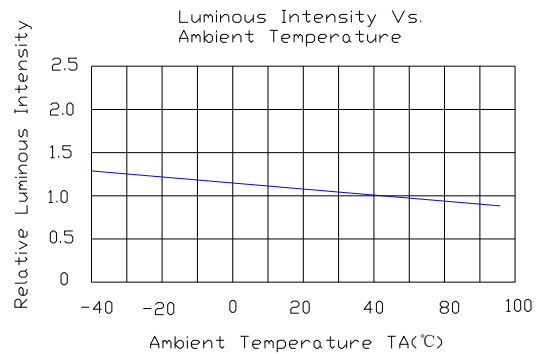
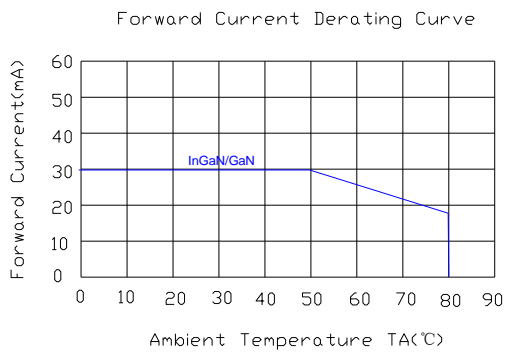
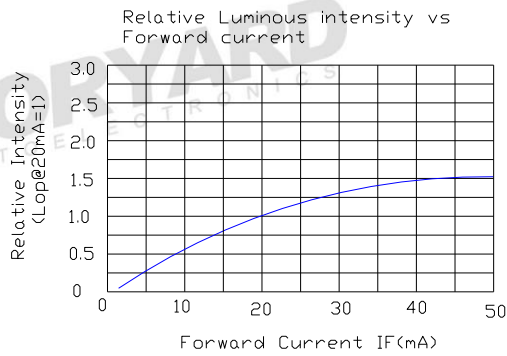
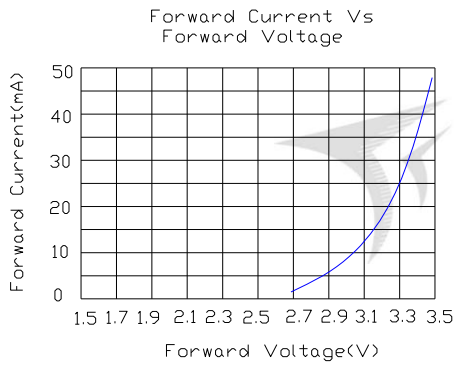
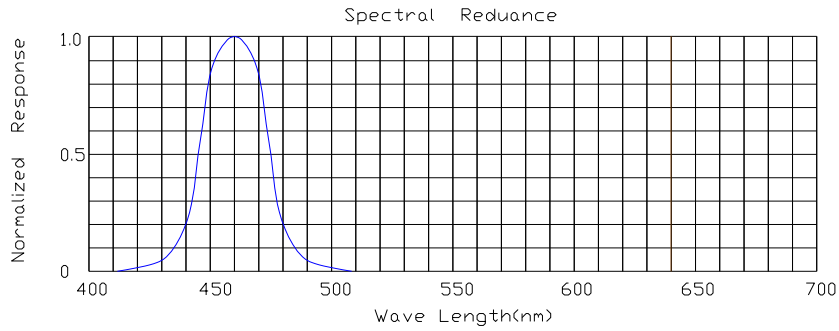

■ Radiation pattern

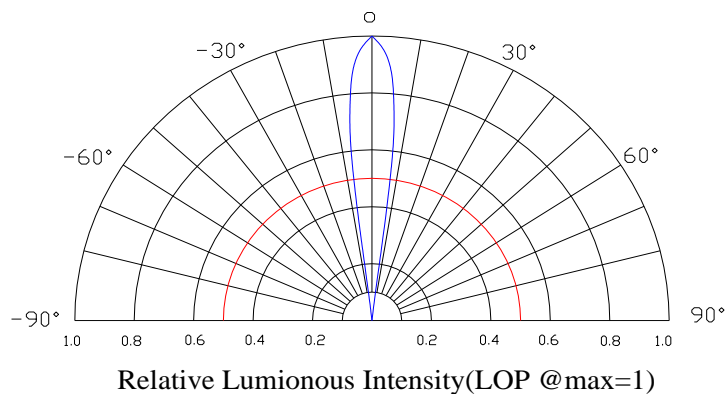

Model No.	FYL-8013UBC1B
Date / Rev.	2020.04.29 / A

Model No.: FYL-8013UBC1B

■ LAMP PACKING.

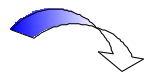
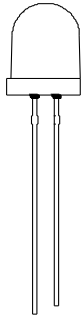

8mm 250PCS/Polybag

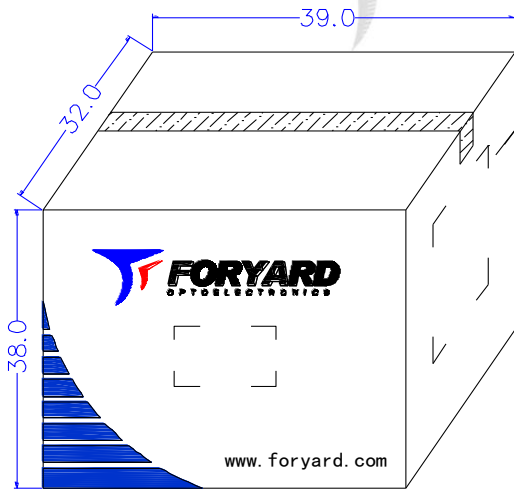

12000PCS/Carton

OUTSIDE LABEL

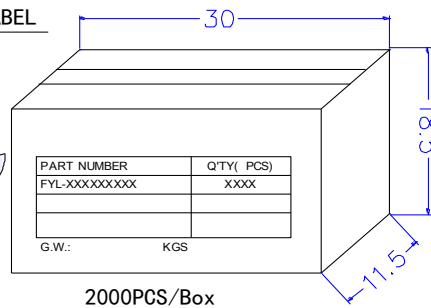

2000PCS/Box

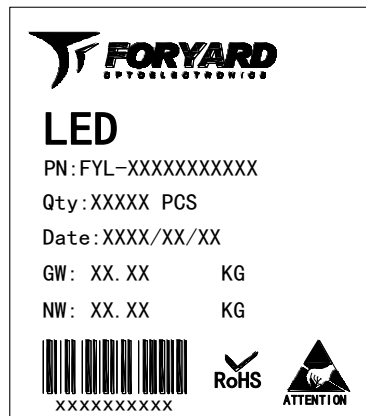

OUTSIDE LABEL

Note: The specifications are subject to change without notice. Please contact us for updated information.