

Supplier name:
Ningbo Sunpu Opto Semicinductor Co.,Ltd

cknowledgment number:

Product Acknowledgment

Customer Name:

Supply-side model:

Acknowledgment Effective Date:

Manufacturers		Client Confirm (Quality)		Client Confirm (R & D)	
Prepared		Qualified <input type="checkbox"/>		Qualified <input type="checkbox"/>	
		Unqualified <input type="checkbox"/>		Unqualified <input type="checkbox"/>	
Audit		Audit		Audit	
Approve		Approve		Approve	

(After both sides confirmed the Acknowledgment qualified,must be signed and sealed)

Supply-side Address: No 150.XinHui Road, Hi-Tech Park,Ningbo,china

Tel: 0574-87740939



COB-G5 series

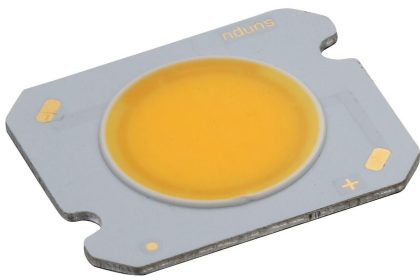

Product introduction

The series of products ,which use mirror aluminum for substrate.The products have high brightness, long life, a variety of power, easy installation, general size, which are especially suitable for indoor and outdoor lighting products, etc.

Features:

- ✧ High brightness、 high reliability、 long life
- ✧ Light angle: 120°
- ✧ Typical color temperature:
6500K/5000K/4000K/3500K/3000K/2700K
- ✧ Ra : 80+
- ✧ Through the LM-80 certification
- ✧ In line with the EU ROHS standard

Contents

Outline dimensions	3
Circuit structure.....	3
Limit parameter	3
Photoelectric parameters	4
Typical curve	6
Chromaticity Coordinates Ranks	7
Reliability test and results.....	9
Packaging	10
Using and attention	11
Model naming rules.....	11

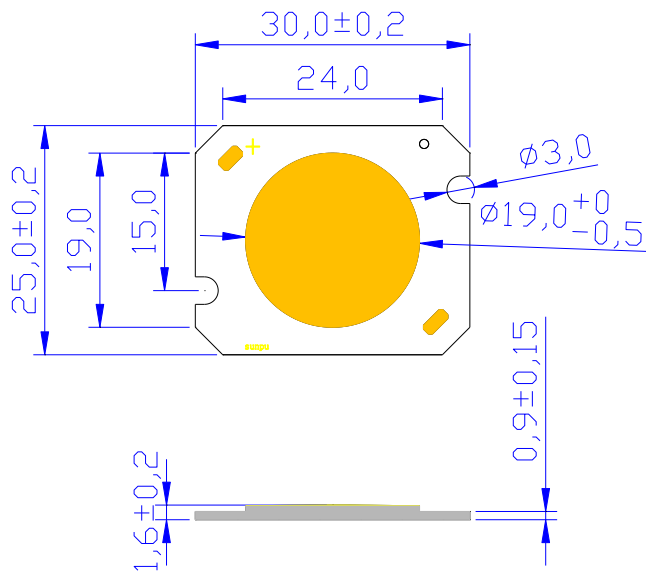
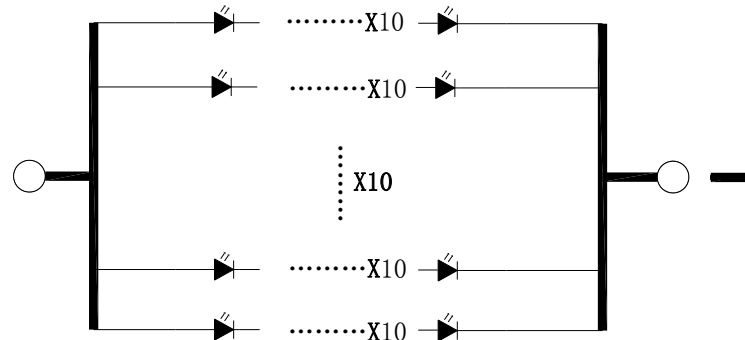
Part No.: G5-XXXX1010-5030MX
Outline dimensions

Circuit structure

NOTES:

- ✧ All dimensions are millimeter.
- ✧ Tolerance is $\pm 0.3\text{mm}$ unless otherwise noted.
- ✧ It is strongly recommended that the temperature of T_s (Welding plate) is not higher than 100°C .

Limit parameter (Ta = 25°C)

Parameter	Symbol	Test Condition	Value		Unit
			Min.	Max.	
DC Forward Current	I_F	----	----	1500	mA
Peak Pulse Current	I_{peak}	Duty=1/10 1kHz	----	1700	mA
Power Dissipation	P_d	----	----	49.5	W
LED Junction Temperature	T_J	----	----	125	$^\circ\text{C}$
Operating Temperature	T_{opr}	----	-40	+85	$^\circ\text{C}$
Storage Temperature	T_{str}	----	-40	+100	$^\circ\text{C}$
ESD Sensitivity	----	HBM	8000	----	V
Soldering Temperature	----	----	300°C for 5 Seconds max		

Part No.: G5-XXXX1010-5030MX
Photoelectric parameters (Ta = 25°C)

ANSI	Parameter	Symbol	Test Condition	Min	Typ	Max	Unit
2700K	Forward Voltage	V_F	$I_F = 1000\text{mA}$		30		V
	Luminous Flux	Φ_v			3150		lm
	Color Temperature	CCT		2650	2725	2800	K
	Color Rendening	R_a		80			
	Thermal Resistance	R_J			0.8		°C/W
3000K	Forward Voltage	V_F	$I_F = 1000\text{mA}$		30		V
	Luminous Flux	Φ_v			3450		lm
	Color Temperature	CCT		2970	3045	3120	K
	Color Rendening	R_a		80			
	Thermal Resistance	R_J			0.8		°C/W
3500K	Forward Voltage	V_F	$I_F = 1000\text{mA}$		30		V
	Luminous Flux	Φ_v			3600		lm
	Color Temperature	CCT		3350	3465	3580	K
	Color Rendening	R_a		80			
	Thermal Resistance	R_J			0.8		°C/W
4000K	Forward Voltage	V_F	$I_F = 1000\text{mA}$		30		V
	Luminous Flux	Φ_v			3750		lm
	Color Temperature	CCT		3850	3985	4125	K
	Color Rendening	R_a		80			
	Thermal Resistance	R_J			0.8		°C/W
5000K	Forward Voltage	V_F	$I_F = 1000\text{mA}$		30		V
	Luminous Flux	Φ_v			3900		lm
	Color Temperature	CCT		4850	5030	5210	K
	Color Rendening	R_a		80			
	Thermal Resistance	R_J			0.8		°C/W
6500K	Forward Voltage	V_F	$I_F = 1000\text{mA}$		30		V
	Luminous Flux	Φ_v			4050		lm
	Color Temperature	CCT		6190	6530	6910	K
	Color Rendening	R_a		80			
	Thermal Resistance	R_J			0.8		°C/W

Part No.: G5-XXXX1010-5030MX

IEC	Parameter	Symbol	Test Condition	Min	Typ	Max	Unit
2700K	Forward Voltage	V_F	$I_F = 1000\text{mA}$		30		V
	Luminous Flux	Φ_v			3150		lm
	Color Temperature	CCT		2650	2725	2800	K
	Color Rendering	R_a		80			
	Thermal Resistance	R_J			0.8		$^{\circ}\text{C}/\text{W}$
3000K	Forward Voltage	V_F	$I_F = 1000\text{mA}$		30		V
	Luminous Flux	Φ_v			3450		lm
	Color Temperature	CCT		2850	2940	3030	K
	Color Rendering	R_a		80			
	Thermal Resistance	R_J			0.8		$^{\circ}\text{C}/\text{W}$
3500K	Forward Voltage	V_F	$I_F = 1000\text{mA}$		30		V
	Luminous Flux	Φ_v			3600		lm
	Color Temperature	CCT		3340	3450	3560	K
	Color Rendering	R_a		80			
	Thermal Resistance	R_J			0.8		$^{\circ}\text{C}/\text{W}$
4000K	Forward Voltage	V_F	$I_F = 1000\text{mA}$		30		V
	Luminous Flux	Φ_v			3750		lm
	Color Temperature	CCT		3850	3985	4125	K
	Color Rendering	R_a		80			
	Thermal Resistance	R_J			0.8		$^{\circ}\text{C}/\text{W}$
5000K	Forward Voltage	V_F	$I_F = 1000\text{mA}$		30		V
	Luminous Flux	Φ_v			3900		lm
	Color Temperature	CCT		4820	5000	5180	K
	Color Rendering	R_a		80			
	Thermal Resistance	R_J			0.8		$^{\circ}\text{C}/\text{W}$
6500K	Forward Voltage	V_F	$I_F = 1000\text{mA}$		30		V
	Luminous Flux	Φ_v			4050		lm
	Color Temperature	CCT		6190	6530	6910	K
	Color Rendering	R_a		80			
	Thermal Resistance	R_J			0.8		$^{\circ}\text{C}/\text{W}$

Part No.: G5-XXXX1010-5030MX

Sunpu-6000K	Parameter	Symbol	Test Condition	Min	Typ	Max	Unit
6000K	Forward Voltage	V_F	$I_F = 1000\text{mA}$		30		V
	Luminous Flux	Φ_v			4050		lm
	Color Temperature	CCT		5720	6000	6350	K
	Color Rendering	R_a		80			
	Thermal Resistance	R_J			0.8		$^{\circ}\text{C}/\text{W}$

Typical curves:

Fig.1 Forward Current (mA) Vs Forward Voltage (V)

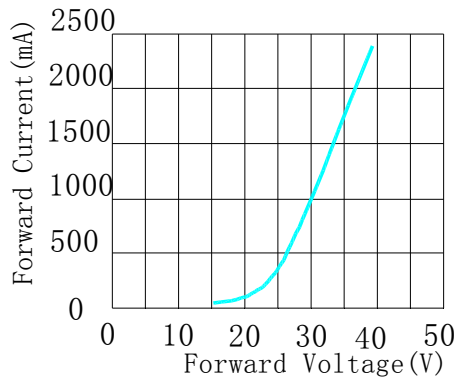

Fig.2 Relative Intensity Vs Forward Current (mA)

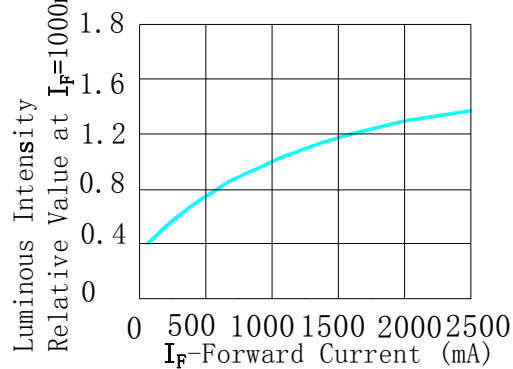

Fig.3 Forward Current Vs Ambient Temperature

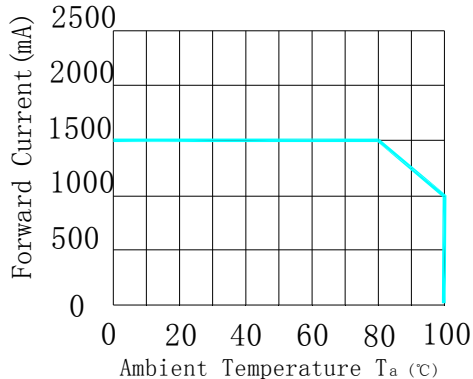
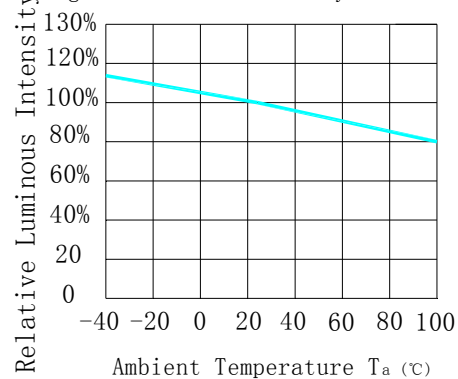
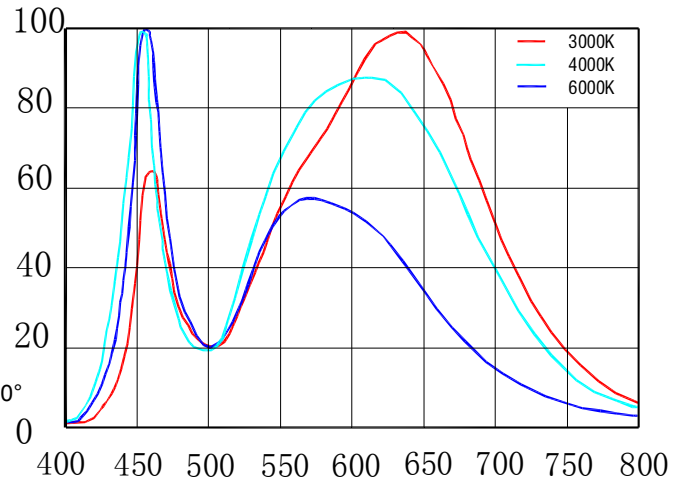
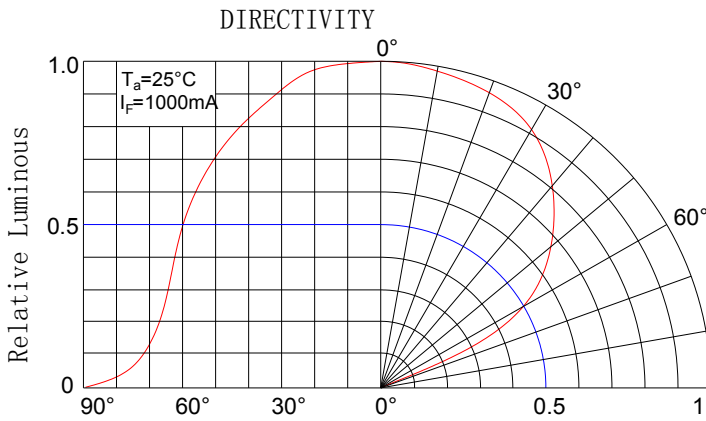

Fig.4 Relative Intensity Vs Ambient Temperature



Part No.: G5-XXXX1010-5030MX



Chromaticity Coordinates Ranks($I_F=1000mA$ $T_a=25^\circ C$)

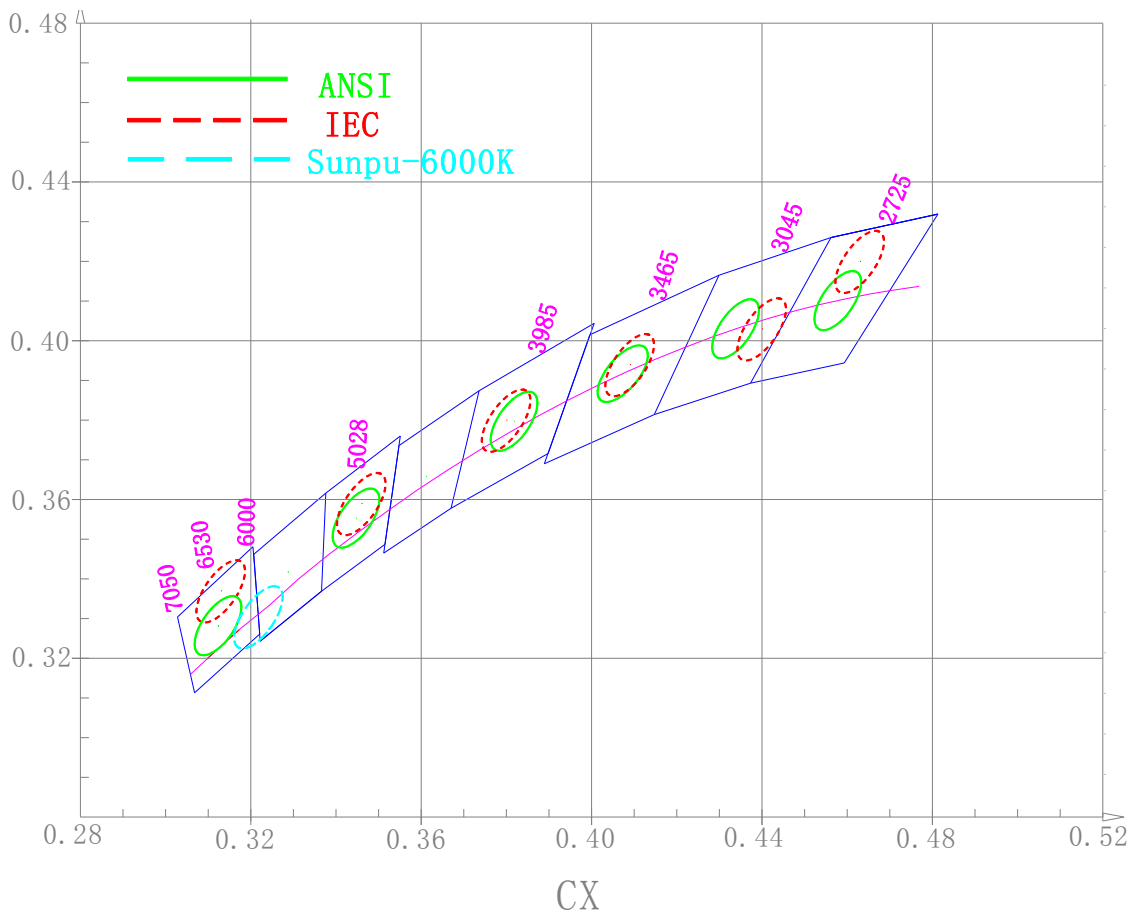

Part No.: G5-XXXX1010-5030MX

Stands	Colour temperature	Center of Coordinates		Long axis	Minor axis	Gradient	Explain
		X	Y				
ANSI	TC	X	Y	a	b	θ	SDCM
	6500K	0.3123	0.3282	0.00892	0.0038	58.23	4-step MacAdam
	5000K	0.3447	0.3553	0.00822	0.00354	59.62	3-step MacAdam
	4000K	0.3818	0.3797	0.00939	0.00402	53.72	
	3500K	0.4073	0.3917	0.00951	0.00417	52.58	
	3000K	0.4338	0.403	0.00714	0.00408	53.22	
2700K	0.4578	0.4101	0.00774	0.00411	53.7		
IEC	6500K	0.3123	0.3282	0.00892	0.0038	58.23	4-step MacAdam
	5000K	0.3447	0.3553	0.00822	0.00354	59.62	3-step MacAdam
	4000K	0.3818	0.3797	0.00939	0.00402	53.72	
	3500K	0.4073	0.3917	0.00951	0.00417	52.58	
	3000K	0.4338	0.403	0.00714	0.00408	53.22	
	2700K	0.4578	0.4101	0.00774	0.00411	53.7	
Sunup-6000K	6000K	0.3217	0.3303	0.00892	0.0038	58.23	4-step MacAdam

Code	Colour temperature
W27	2700K
W30	3000K
W35	3500K
W40	4000K
W50	5000K
W60	6000K
W65	6500K

Notes:

- ✧ Our company deliver according to the 3 order macadam ellipses among 2700K-5000K and deliver the 4 order macadam ellipses among 6000K-6500K for above 3 stands.
- ✧ Tolerance of measurements of the Forward Voltage is $\pm 2\%V$
- ✧ Tolerance of measurements of the Luminous Flux is $\pm 15\%$
- ✧ Tolerance of measurements of the Color Rendering R_a is ± 2
- ✧ Chromaticity Coordinates (x,y) is measured with an accuracy of ± 0.01
- ✧ The center of Coordinates (x,y) is based on C78.377:2008 ANSI reference
- ✧ Ellipse refer to IEC 60081:1997
- ✧ Ranking at $T_c=25^\circ C$

Part No.: G5-XXXX1010-5030MX

BIN	Luminous Flux (lm)	BIN	Luminous Flux (lm)
A	0-5	R2	3000-3500
B	5-10	S2	3500-4000
C	10-15	T2	4000-4500
D	15-20	U2	4500-5000
E	20-25	V2	5000-5500
F	25-30	W2	5500-6000
G	30-35	X2	6000-6500
H	35-40	Y2	6500-7000
J	40-50	Z2	7000-7500
K	50-60	A3	7500-8000
L	60-80	B3	8000-8500
M	80-100	C3	8500-9000
N	100-120	D3	9000-9500
P	120-140	E3	9500-10000
Q	140-160	F3	10000-10500
R	160-180	G3	10500-11000
S	180-200	H3	11000-11500
T	200-240	J3	11500-12000
U	240-280	K3	12000-12500
V	280-320	L3	12500-13000
W	320-360	M3	13000-13500
X	360-400	N3	13500-14000
Y	400-450	P3	14000-14500
Z	450-500	Q3	14500-15000
A2	500-600	R3	15000-15500
B2	600-700	S3	15500-16000
C2	700-800	T3	16000-16500
D2	800-900	U3	16500-17000
E2	900-1000	V3	17000-17500
F2	1000-1200	W3	17500-18000
G2	1200-1400	X3	18000-18500
H2	1400-1600	Y3	18500-19000
J2	1600-1800	Z3	19000-19500
K2	1800-2000	A4	19500-20000
L2	2000-2200	B4	20000-20500
M2	2200-2400	C4	20500-21000
N2	2400-2600	D4	21000-21500
P2	2600-2800	E4	21500-22000
Q2	2800-3000	F4	22000-22500

Part No.: G5-XXXX1010-5030MX
Reliability Tests and Results

Test	Reference Standard	Test Conditions	Test Duration	Units Failed/Tested
Temperature Cycle	JEITA ED-4701 100 105 or MIL-STD-202 G	-40°C(30min)↔25°C(5min)↔ 100°C(30min)↔25°C(5min)or -40°C(30min)↔100°C(30min)	100cycles	0/10
High Temperature Storage	JEITA ED-4701 200 201	T _A =100°C	1000hours	0/10
High Temperature Humidity Storage	JEITA ED-4701 100 103	T _A =85°C RH=90%	1000hours	0/10
Low Temperature Storage	JEITA ED-4701 200 202	T _A =-40°C	1000hours	0/10
High Temperature Operating Life	JESD22-A108D	T _C =85°C I _F =500mA	1000hours	0/10
Electrostatic Discharges	JEITA ED-4701 300 304	HBM 8KV 3KΩ 100Pf 3pulses negative		0/10
Temperature Cycle *1	Sunpu-opto	-40°C(30min)↔(90s)↔110°C (30min)↔(90s)-40°C	300cycles	0/10
Temperature Humidity Storage*2	Sunpu-opto	T _A =85°C RH=85% I _F =1000mA	1000hours	0/10

NOTES:

* Measurements are performed after allowing the LEDs to return to room temperature

Failure Criteria

Items	Conditions	Failure Criteria
Forward Voltage (VF)	I _F =1000mA	>Initial value x 1.1
Luminous Flux (ΦV)	I _F =1000mA	<Initial value x 0.7

Part No.: G5-XXXX1010-5030MX

Packaging

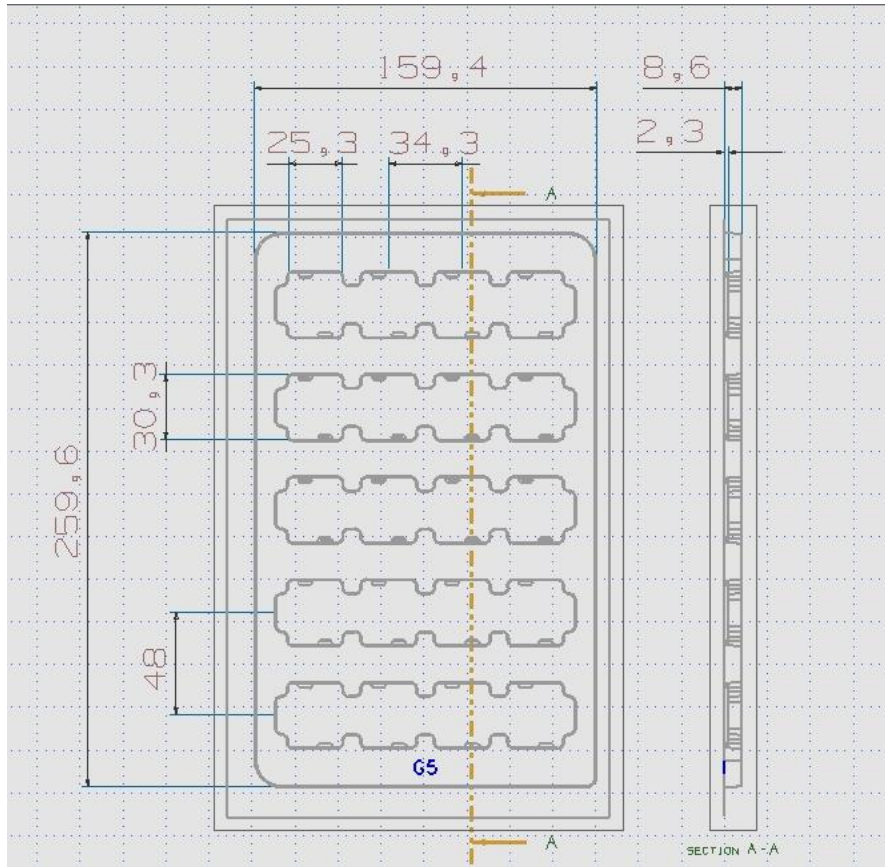

20PCS for each layer

Label instructions

 <p>升谱光电 SUNPU OPTO</p>	
Lot No:	81307075001
P/N:	SPC-NWW3.6-400C1
Rank:	ANSI- B2/W30III/Ra80
Q' ty:	0.03kpcs QC: _____
Date:	2013-08-05

- Explain:
- 0) Lot No: Product batch number
 - 1) P/N: Product model
 - 2) Rank: "Color standard" - "Brightness code"
/ "Color coordinate code" / "Ra"
 - 3) Q,ty: Product quantity
 - 4) QC: Qc inspection
 - 5) Date: The date of production

Part No.: G5-XXXX1010-5030MX

Using and attention

1、 Soldering

COB light source device is a very fragile encapsulation device. Careless in the process of soldering operation will cause the damage of the products easily and even lead to death lamp. client should be cautious. In the process of soldering iron or other welding equipment to heat up, please don't use hand or other items to put any pressure on the surface of a product, please avoid iron touch within white rubber dam. because under the white dam it is likely to be the gold thread connection with substrate. If it is extruded by any external things, it is likely cause that connections between gold wire and substrate loose or fall off leading to product stroboscopic at work or death lamp. soldering temperature shall not be higher than 350 °C and the time shall not be more than 3 seconds and the number less than 2 times. When the soldering operation is completed, it is necessary that the product is cooled to room temperature, then washed again, and other operations.



2、 Cleaning

After soldering it is recommended that client should use alcohol to clean, The specific method is that

Part No.: G5-XXXX1010-5030MX

Using tweezers clamping alcohol cotton ball in the source surface lightly wipe back and forth to clean, Prohibit the forceps tip injury to the source surface .Before using other similar solvent cleaning, please make sure that to use the solvent will not damage the product packaging materials such as silica gel and phosphor etc.

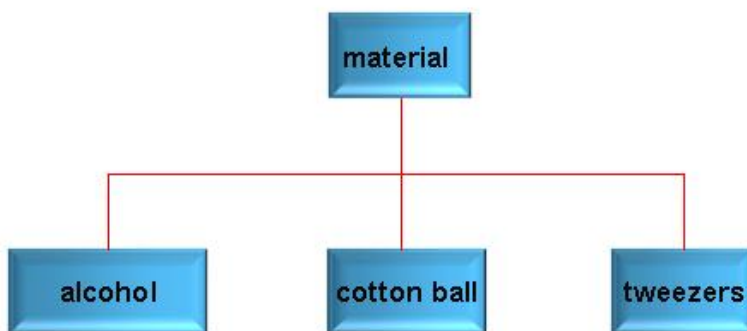

3、 Storage

This product use sealed moisture-proof anti-static bag packaging, storage method is as follows:

- ✧ Opened before, the product must be stored in room temperature and humidity environment is not higher than 70% RH.
- ✧ Once opened, the product can be stored in room temperature and humidity is not higher than 70% RH of the environment in a week, please use in the period of time.

If not timely installation after opening, Should be stored in dry cabinet temperature and humidity not higher than 10%RH .

Part No.: G5-XXXX1010-5030MX**4、 Static electricity**

Static and surge can cause product characteristics change, such as forward voltage to reduce, if severe cases may even damage the product. So When in use effective anti-static measures must be taken. All related equipment and machines should be properly grounded, at the same time must take other measures to prevent static and surge. Use anti-static bracelet, anti-static MATS, anti-static overalls, work shoes, gloves, anti-static container, are effective measures to prevent static and surge.

**5、 Driving and cooling scheme**

In the design of driving, by the current cannot exceed a maximum value specified products. Over voltage, over current pulses generated at the moment of the power switch or reverse voltage pulse may cause product damage and even death light. Therefore it is recommended that choose drive power selection of high stability. Because the heat this for product is concentrated, It should be the choice of high thermal conductivity thermal grease or conductive adhesive and Evenly coated on the light back. There can be no gap between substrate and radiator.



Part No.: G5-XXXX1010-5030MX

6、 Halogen

Halogen will damage the product, affecting device performance. Reference standards such as IEC, IPC and JPCA - ES, customers to use material, each kind of halogen content shall not be higher than 900 PPM, halogen sum shall not be higher than 1500 PPM.

- ✧ Halogen include: F, Cl, Br, I
- ✧ Common containing halogen material: white oil, pouring sealant, sealant, line insulation casing, etc.

7、 External force

Packaging adhesive products (including the white dam colloid) is fragile , when in use should pay attention to the following points:

- ✧ Do not use hard, sharp objects scratch, wipe the packaging adhesive part.
- ✧ Do not hand take products, avoid pollution package silica surface, and influence its optical properties.
- ✧ It should be noted that when using tweezers clip excessive pressure may damage , packaging silica gel , for example, damage, scratches, peeling, serious deformation and die lamp.
- ✧ Products dropped, the product may lead to deformation.

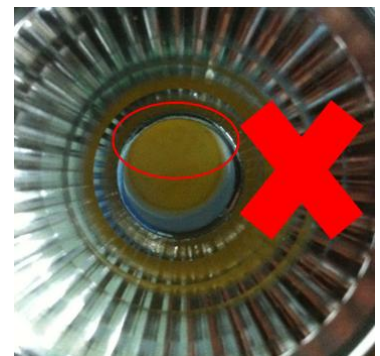
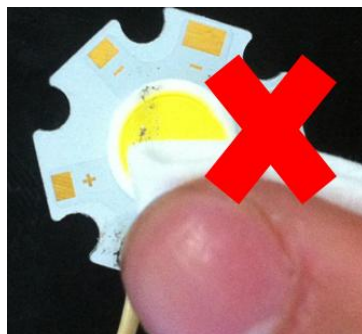

Part No.: G5-XXXX1010-5030MX



Model naming rules

G16-27 3 H 01 12-06 04 M A
X1 X2 X3 X4 X5 X6 X7 X8 X9 X10

- 一、X1: Substrate type
 - 二、X2: Color temperature
 - 三、X3: Tolerance range of Color tolerance or color temperature
 - 四、X4: Ra
 - L : 70 +
 - H : 80 +
 - U : 90 +
 - X : 93 +
 - Y : 95 +
 - 五、X5: The number of parallel
 - 六、X6: The number of series
 - 七、X7: }
 - 八、X8: }
 - 九、X9: }
- X7 X8 X9 : Internal encoding
- 十、X10: A:ANSI B:IEC C:Sunpu-6000K