



深圳市联佑光电技术有限公司

SHENZHEN LEARNEW OPTOELECTRONICS TECHNOLOGY CO.,LTD.
TEL:0755-29084995 FAX:0755-23224565 WEB:www.learnew-led.com

产品规格书

SPECIFICATION

产品型号 Model. P/N NO.: LN-CVS35UV-P120(30DEG)

文件编号 Document. NO.:

版 次 REV NO.:

送承日期 Documents. NO.: 2017-08-17

描述 Description:

- 35×35mm 垂直 UVA 集成光源 35x35mm Vertical UVA COB
- 基板材质 Substrate material: 氮化铝陶瓷 ALN+Coppering ceramics
- 封装材料 Housing Material: 石英玻璃 Quartz glass

深圳市联佑光电技术有限公司 Shenzhen Learnew Optoelectronics Technology Co.,Ltd			客户承认/Customer approval (加盖公章/Seal)		
技术部 R&D		品保部 QRA	市场部 MKT	公司名称 Company name:	
制作 Maker	审核 Checked	QA	业务员 Salesman	客户技术部门 Technique department	客户采购部门 Purchasing Department

地址: 深圳市光明新区凤凰街道甲子塘第二工业区 2 号 A 栋 3 楼

Add: 3F,Block A,No 2,2nd industry estate of Jiazitang,Phoenix street, Guangming Dist ,Shenzhen City.

Tel/电话: 0755--29084995

Fax/传真: 0755--23224565

Web/网址: <http://www.learnew-led.com>



深圳市联佑光电技术有限公司

SHENZHEN LEARNW OPTOELECTRONICS TECHNOLOGY CO.,LTD.
TEL:0755-29084995 FAX:0755-23224565 WEB:www.learnw-led.com

1.外形尺寸 Dimensions

单位(Units):毫米(mm)

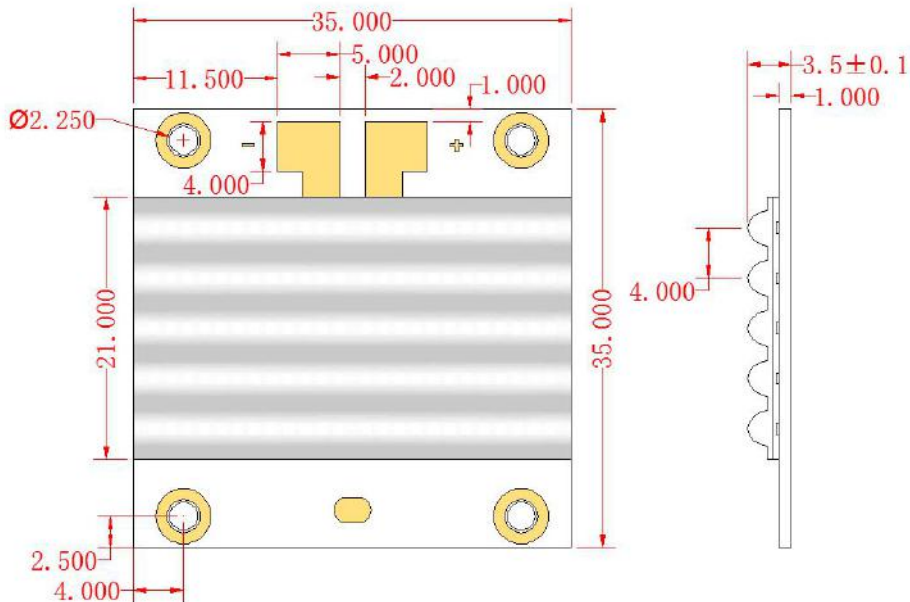
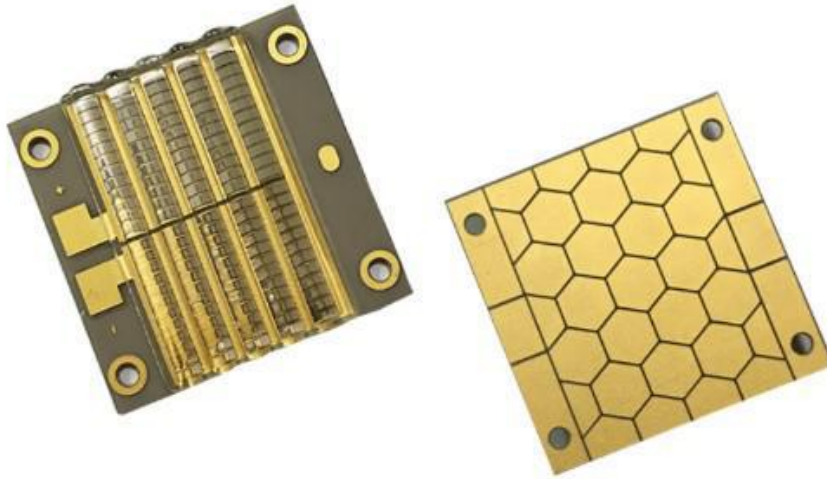

注意:

所有尺寸单位为 mm ， 如无特殊说明误差范围为±0.1mm

All dimensions area in mm tolerance is ±0.1mm unless otherwise noted.



深圳市联佑光电技术有限公司

SHENZHEN LEARNEW OPTOELECTRONICS TECHNOLOGY CO.,LTD.
TEL:0755-29084995 FAX:0755-23224565 WEB:www.learnew-led.com

2. 光电特性 Electrical / Optical characteristics

(1) .极限参数 Absolute Maximum Ratings

项目/Item	符号/Symbol	数值/Value	单位/Unit
输入电压 Input Voltage	VF	32-40	V
峰值电流 Peak Current	IFp	12.0	A
工作温度 Operating Temperature	Topr	-40°C To +80°C	°C
结点温度 Junction Temperature	Tj	125	°C
储存温度 Storage Temperature	Tstg	-40°C To +110°C	°C



深圳市联佑光电技术有限公司

SHENZHEN LEARNEW OPTOELECTRONICS TECHNOLOGY CO.,LTD.
TEL:0755-29084995 FAX:0755-23224565 WEB:www.learnew-led.com

(2) 产品光电参数 Initial Electrical/Optical Characteristics (TA=25±5°C)

IF=8400mA

项目 Item	单位 Units	最小值 Min.	规格值 Typ.	最大值 Max.	测试条件 Test Conditions
输入电压 Input Voltage	V	32	--	40	--
正向电流 DC Forward Current	A	--	8.4	12.0	--
峰值波长 Peak Wavelength	Nm	365	--	405	--
典型光功率 Radiant Flux	mW	95000	--	110000	PW=365nm
		120000	--	140000	PW=385nm
		130000	--	150000	PW=395nm
		1350000	--	155000	PW=405nm
典型光密度 Radiant Intensity	W/cm2	13.0	--	15.0	PW=365nm
		16.0	--	19.0	PW=385nm
		17.7	--	20.5	PW=395nm
		18.0	--	21.0	PW=405nm
工作温度 Operating Temperature	°C	-40	--	80	IF=8.4A(Single chip=700mA)
储存温度 Storage Temperature	°C	-40	--	105	--
发散角度 View angle	DEG	25	30	35	--

注释 Notes:

1. 峰值波长测量误差为±1nm; Measurement tolerance of peak wavelength is ±1nm.
2. 光功率密度值为产品发光表面测量值, 仅供参考, 实际到达应用受体表面光密度与应用条件有关; The value of optical power(radiant flux) here is surface measurement for reference,real value of optical power to the receptor's surface is related with use conditions.
3. 因产品使用功率较高, 应特别注意使用过程中对基板温度的管控, 必须做好散热处理, 建议在满负荷使用时保证基板温度在 50°C 以内; Special attention and control the temp of the substrate in using process,Good heat treatment is necessary due to the high power,Ensure substrate temp below 50C in full load use.
4. 应用过程中, 本产品发出的超强近紫外应注意对眼睛的保护, 必要的情况下请佩戴防紫外墨镜操作; As to protect your eyes in application process,anti-uv sunglasses may necessary in operating.
5. 本产品必须使用横流电源驱动; This product must be driven by constant current power supply.



深圳市联佑光电技术有限公司

SHENZHEN LEARNW OPTOELECTRONICS TECHNOLOGY CO.,LTD.
TEL:0755-29084995 FAX:0755-23224565 WEB:www.learnw-led.com

(3) 典型光功率分布图 Typical Relative Spectral Power Distribution

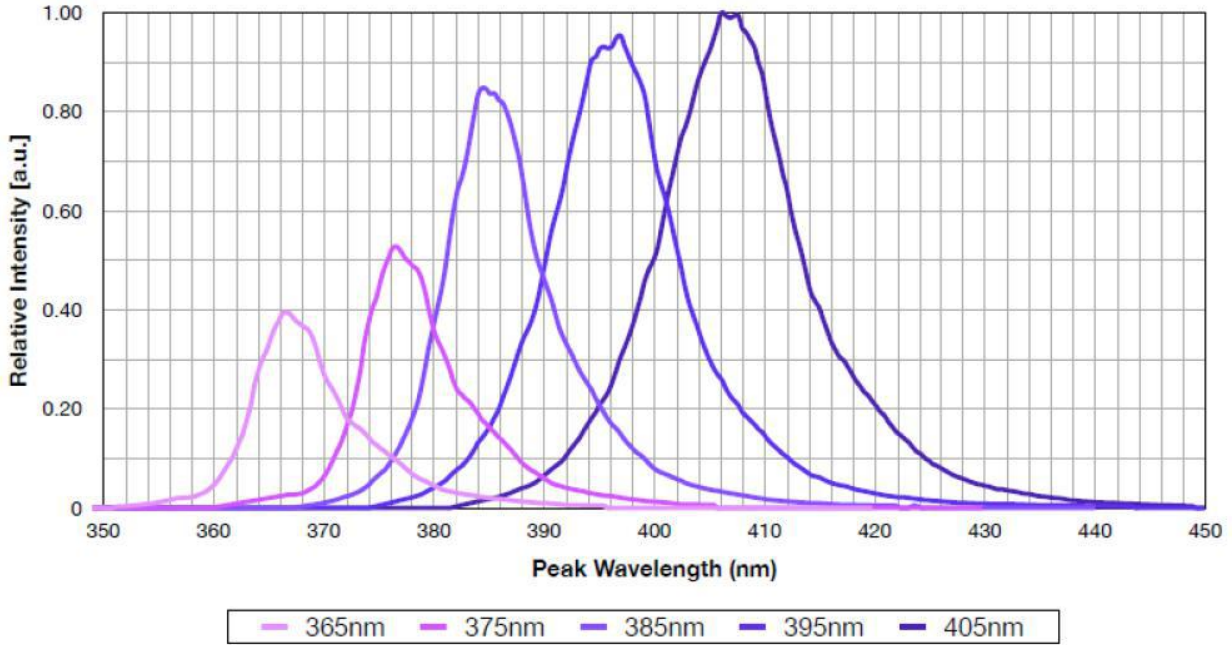

(4) 热结构分析 Thermal Structural Analysis

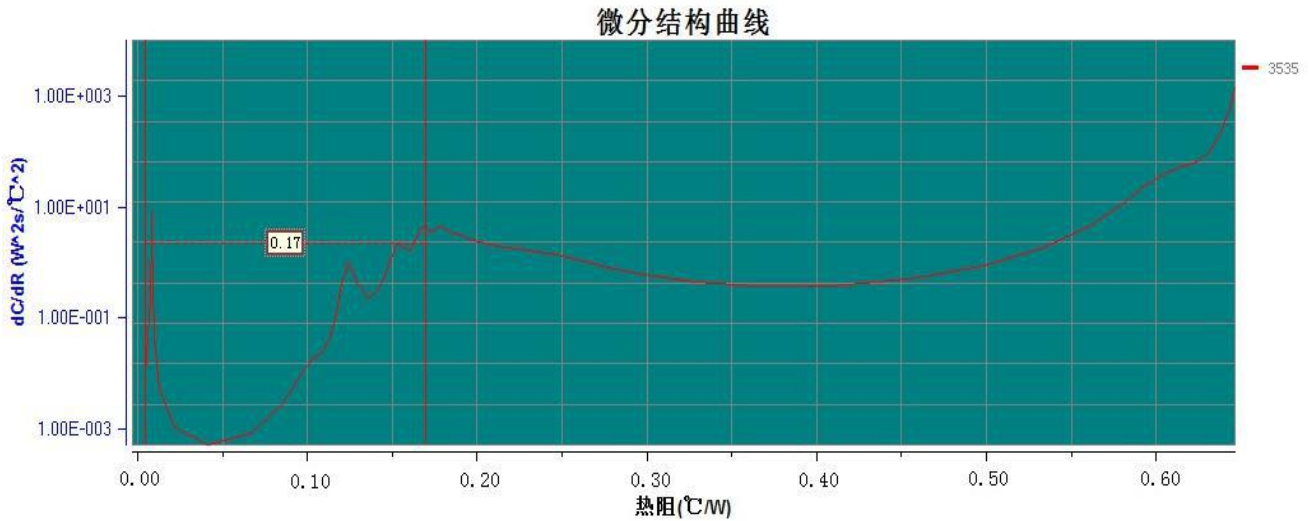

- Thermal Resistance(C/W)



深圳市联佑光电技术有限公司

SHENZHEN LEARNEW OPTOELECTRONICS TECHNOLOGY CO.,LTD.
TEL:0755-29084995 FAX:0755-23224565 WEB:www.learnew-led.com

(5)单颗芯片光功率和电流关系图 Single chip's Radiant flux (Φ_v) vs Current(IF)

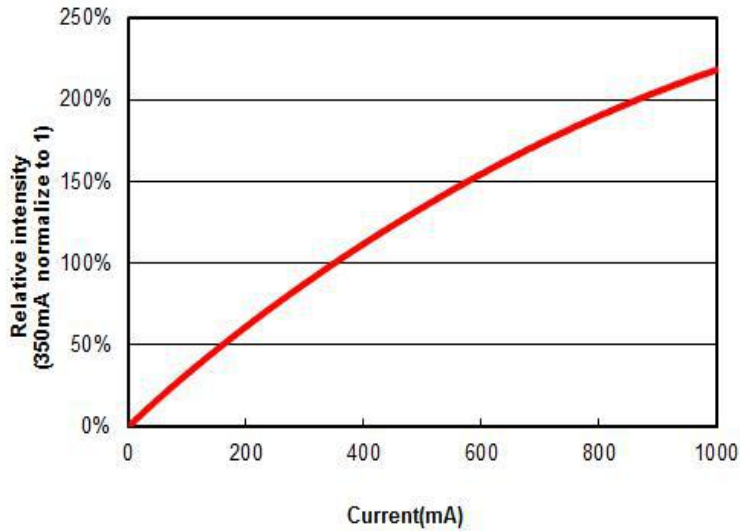

(6)单颗芯片电流和电压的关系图 Single chip's Current(IF) vs Voltage(VF)

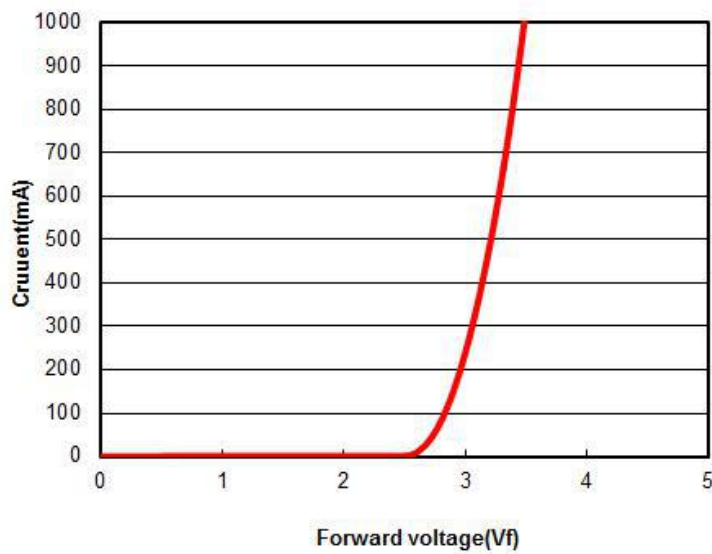



深圳市联佑光电技术有限公司

SHENZHEN LEARNEW OPTOELECTRONICS TECHNOLOGY CO.,LTD.
TEL:0755-29084995 FAX:0755-23224565 WEB:www.learnew-led.com

(7)典型发光图形 Typical radiation pattern

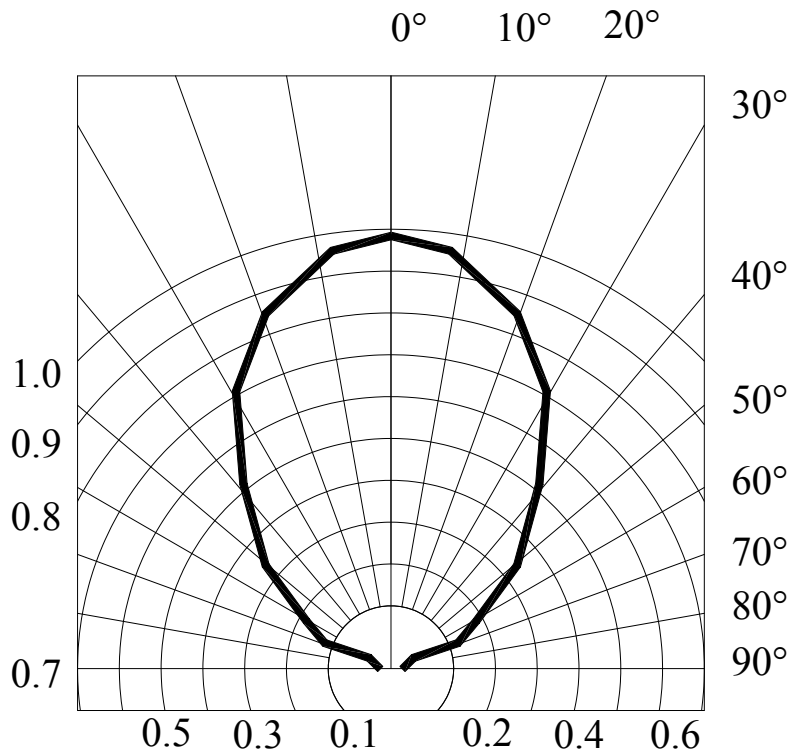



4.注意事项 Cautions

(1).安装 Install

- 1.1 光源必须使用高导热材料与散热体无缝连接。为保证光源底部散热面与散热体接触良好并固定，建议用配套螺丝将光源固定锁紧。

LEDs must use high thermal conductivity material and heat sink in seamless connection. the light source is fixed with a supporting screw is better in order to ensure that the radiating surface of the LEDs is in good contact with the radiating body.

- 1.2 焊接引线温度控制在 420°C 以下 10S 以内；安装过程中避免光源表面残留有异物，以免光源在工作时异物吸收光线导致运作不良。

The temperature of welding wire is 420C(or less than) 10S;Clean the surface of the LEDs in installation process as to avoid dirty things absorb energy and light which lead to poor operating.

(2).储藏 Storage

打开包装袋之前,LED 在温度为 30°C 或更低湿度 60%RH 以下,可保存一年

Before open the package,LEDs can keep stock for one year at condition of ambient temp 30C humidity 60%RH(or less than).

(3).其他注意事项 Other considerations:

- 3.1. 此产品设计不针对下列任何条件，如在下列任何条件下使用产品，请确定其正常性能和可靠性；如：潮湿，有露水凝霜，盐水空气，腐蚀性气体的地方（C1,H2S,NH3,SO2,NOX,等）；太阳直晒下，户外暴露，多灰尘的地方。水中，油，医用液体和有机溶剂等。

This product design is not directed to any of the following conditions,please determine its normal performance and reliability in follow conditions;

Such as wet, there was a layer of dew frost, salt air, corrosive gas local (C1, H2S, NH3, SO2, NOx,); direct sunshine, outdoor exposure, dusty. Water, oil, medical liquids and organic solvents, etc..

- 3.2. 如果 led 光源使用超出规定的正向电流或散热系统不够良好时，有可能会增加产品失效率或衰减过高现象，请使用合适的驱动电流和散热体，以避免产品存在品质隐患。

If LEDs are used in excess of the prescribed forward current or cooling system is not good enough, may, will increase the product failure rate or decay phenomenon of high, please using the appropriate drive current and the radiating body, as to avoid the product quality hidden danger.