

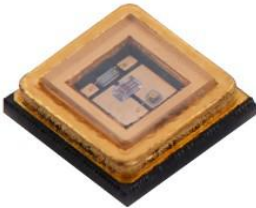

Draft Specification For UV-C Series

LN-SMD3535UVC-P0.5



<p>Features</p> <ul style="list-style-type: none">■ Deep Ultraviolet LED■ Dimension : 3.6mm×3.6mm x1.62mm■ All Metal Design Cu Substrate/ Al reflector■ View Angle :Flat■ Low thermal resistance	<p>Applications</p> <ul style="list-style-type: none">■ Disinfection■ Chemical and Biological analysis
---	--

	<p style="text-align: center;"> CAUTION</p> <ul style="list-style-type: none">• LEDs emit very strong UV radiation.• Don't look directly into the LED light. UV radiation can harm your eyes.• To prevent even inadequate exposure, wear protective eyewear.• If LEDs are embedded in devices, please indicate warning labels against the UV light LED used.• Keep out of reach of children.• Specification and dimension are subject to change for improvement without notice.
---	--

Outline Dimension

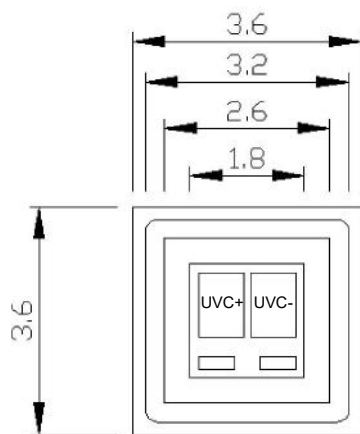

top view

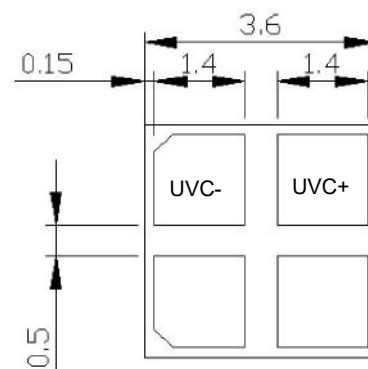

Bottom view

Unit : mm

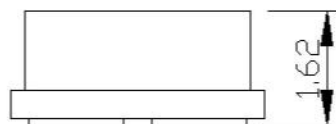

side view

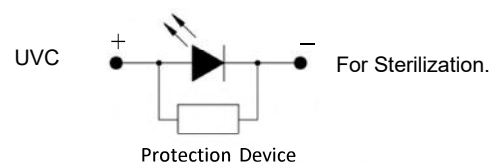

Notes:

1. All dimension units are millimeters.
2. All dimension tolerance is $\pm 0.2\text{mm}$ unless otherwise noted.

Absolute Maximum Ratings

(Ta=25°C)

Parameter	Symbol	Value	Unit
Power Dissipation	P	0.7	W
Forward Current	I _F	40	mA
Maximum Current	I _F	60	mA
Thermal Resistance, Junction-Case	R _{th, J-C1}	15	°C/W
Operating Temperature Range	T _{opr}	- 40°C to + 60°C	
Storage Temperature Range	T _{stg}	- 40°C to + 100°C	
Soldering Condition	T _{sol}	230°C For 5 Seconds	

Note: 1. The thermal resistance value is measured with MCPCB (Star).

Initial Electrical/Optical Characteristics

(Ta=25°C IF=50mA)

Parameter	Symbol	Min	Typ	Max	Unit
Peak wavelength	λ _p	265	275	285	nm
Radiant Flux	Φ _e	4	7	—	mW
Radiant Irradiance	E _e	80	—	120	mW/cm ²
Forward Voltage	V _F	—	6	8	V
Spectra half-width	Δλ	—	15	—	nm
LED Junction Temperature	T _J	—	60	80	°C

Note

1. Forward voltage measurement allowance is ± 0.2V.
2. Radiant flux measurement allowance is ± 10%.
3. Irradiance tested at a distance 10mm from Al reflector.
4. Wavelength measurement allowance is ± 3nm.

Characteristic Diagram

- **Forward Current vs. Forward Voltage**

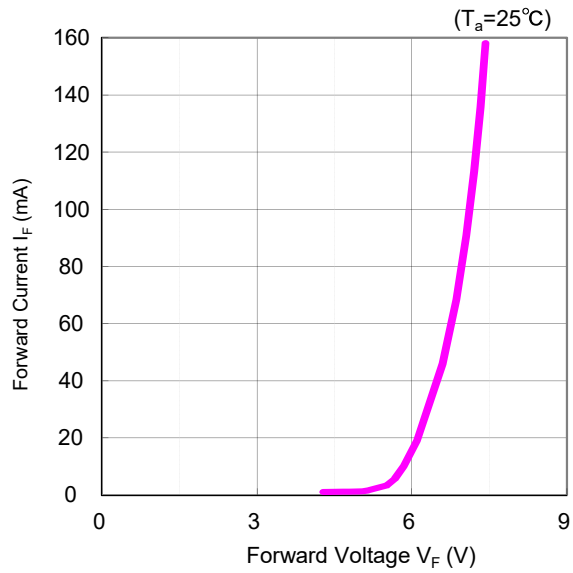

- **Relative Intensity vs. Forward Current**

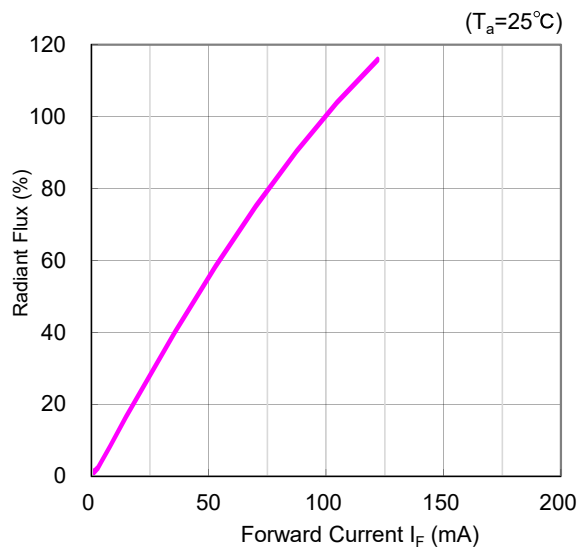

- **Spectral Power Distribution**

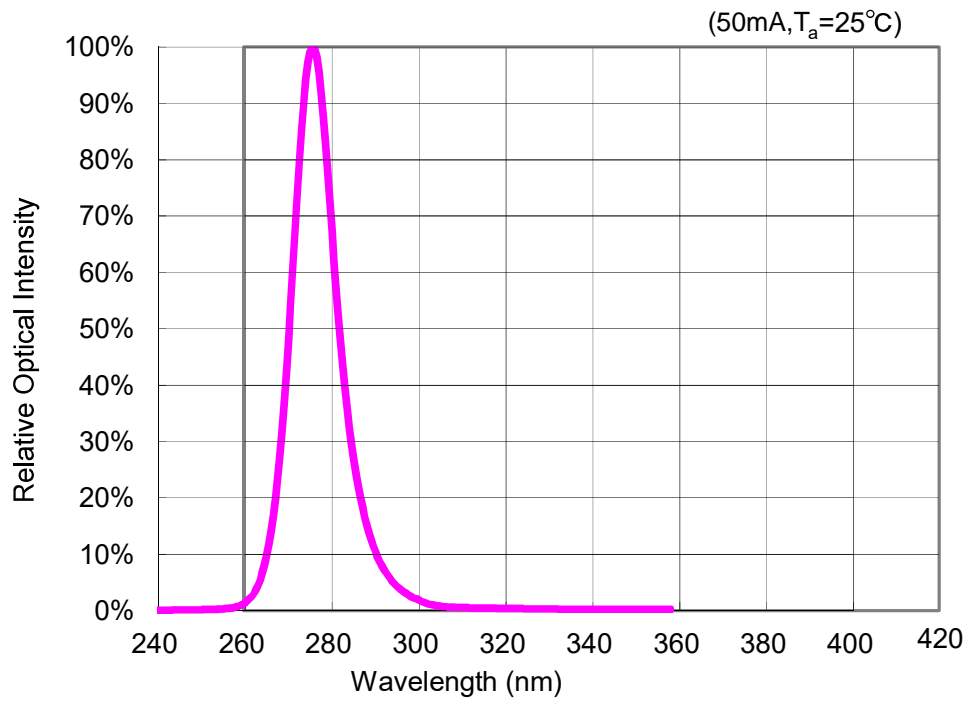

- **Typical Radiation Pattern**

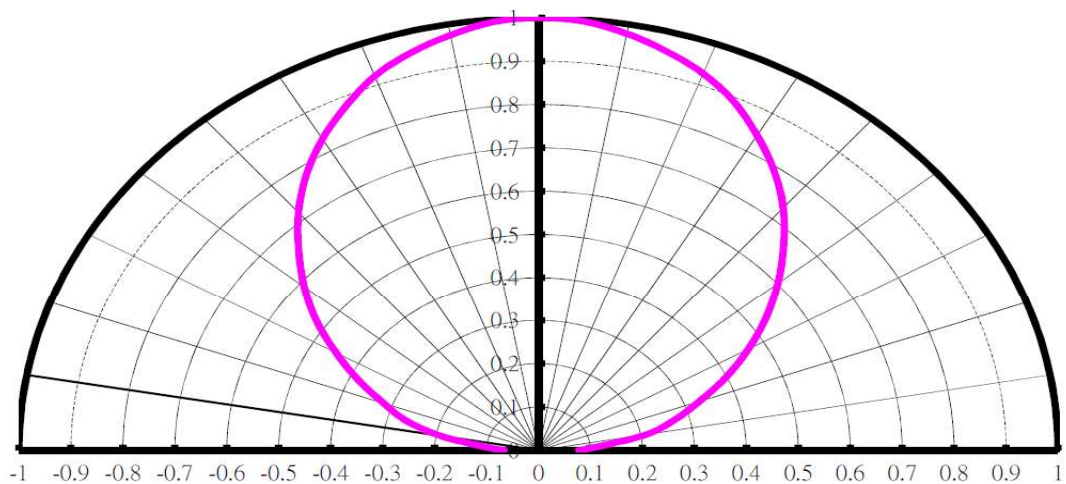

- **Ambient Temperature vs. Relative Radiant Flux, $I_F=50\text{mA}$**

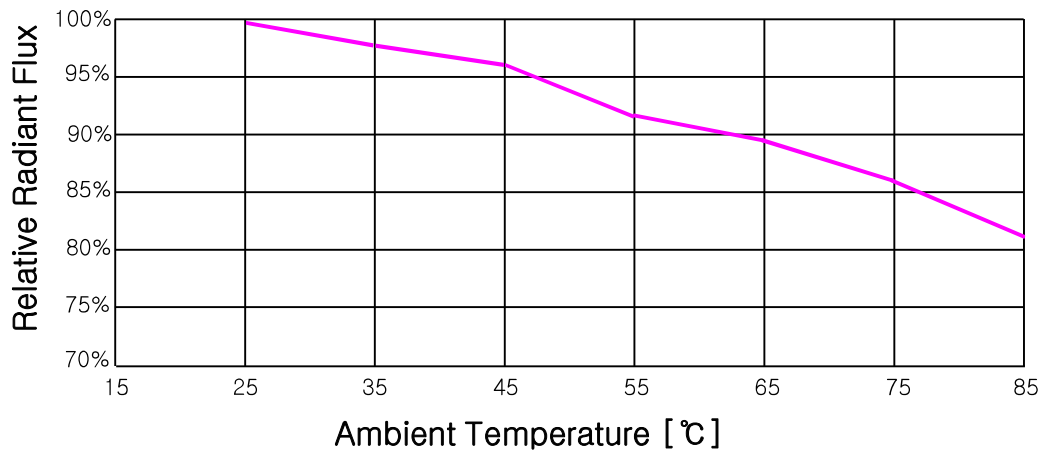

- **Ambient Temperature vs. Peak Wavelength, $I_F=50\text{mA}$**

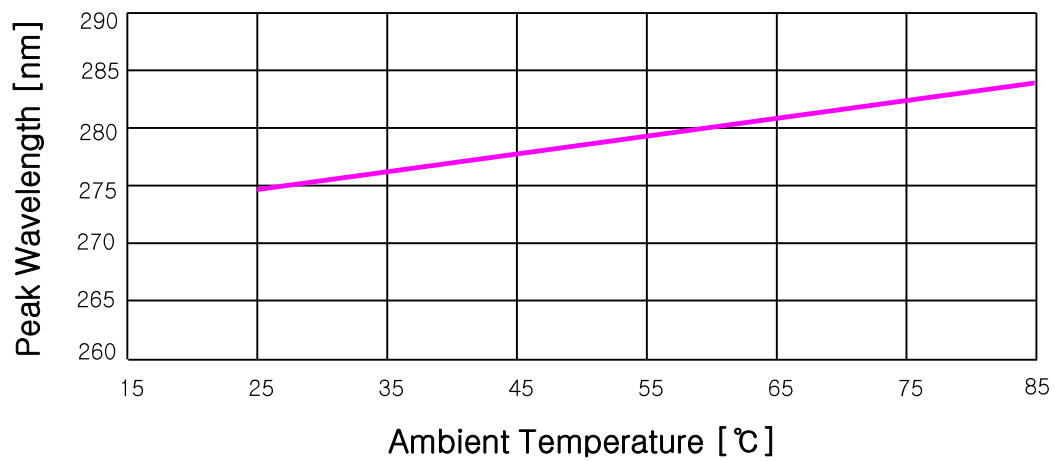

Shipping Package Style

Lens Type

Tapping Dimension Packaging Specification

FLAT Lens Type :

- Moisture proof bag.
- 1 Reel/bag.
- Q'ty: 4000 (MAX)/Reel.

Unit : mm

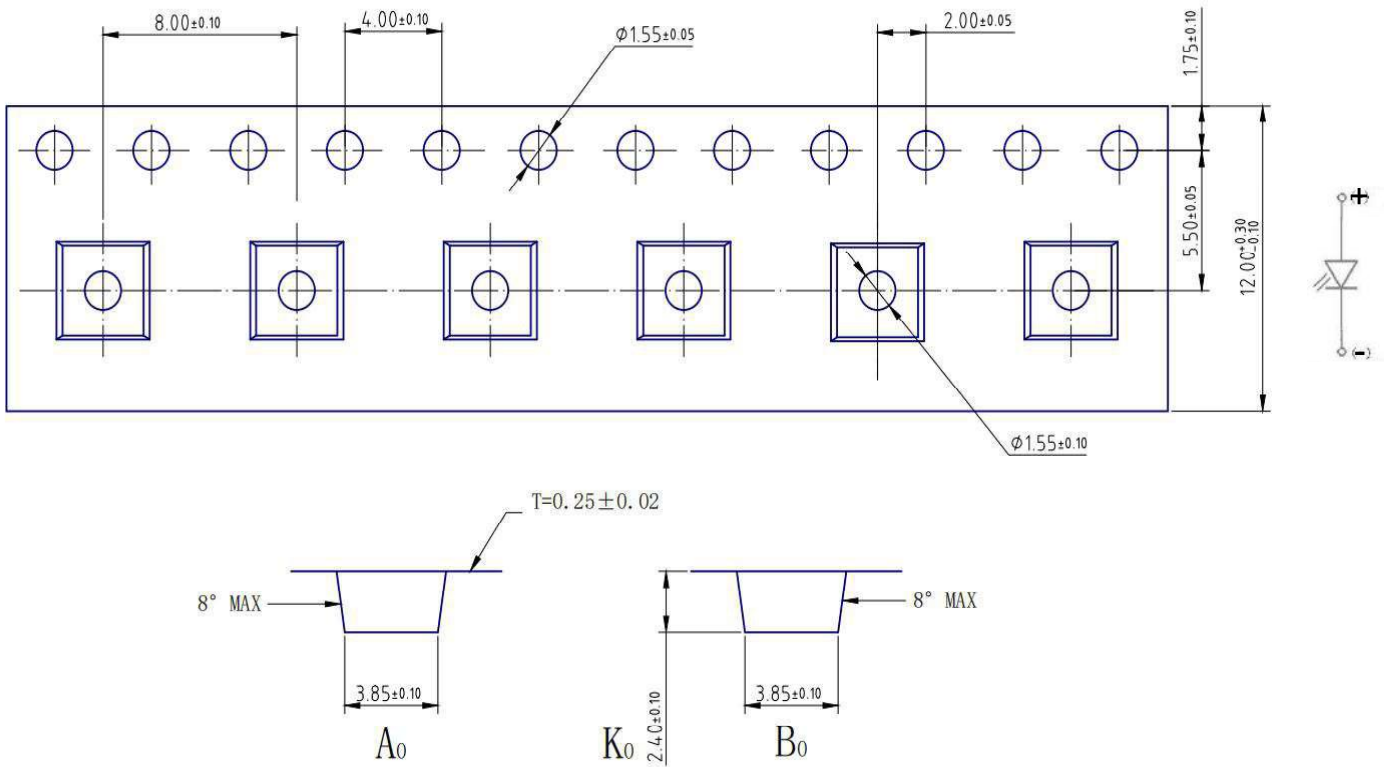

Tapping Dimension Packaging Specification Label Formation

P/N: XXXXXXXXXXXXX	BIN Rank : XXXXXXXXX
LOT: XXXXXXXXXXXXX	Q'ty : XXXX PCS XXX

75mm*8mm

Package

Box Type	Dimension (mm)	Reel/Box	120°Lens Type(Pcs)
Small Box(S)	230x85x265	5 Reel/Box	20000
Middle Box(M)	470x265x270	30 Reel/Box	120000
Large Box(L)	470x435x270	50 Reel/Box	200000

Reel Packaging :

Reel Part :

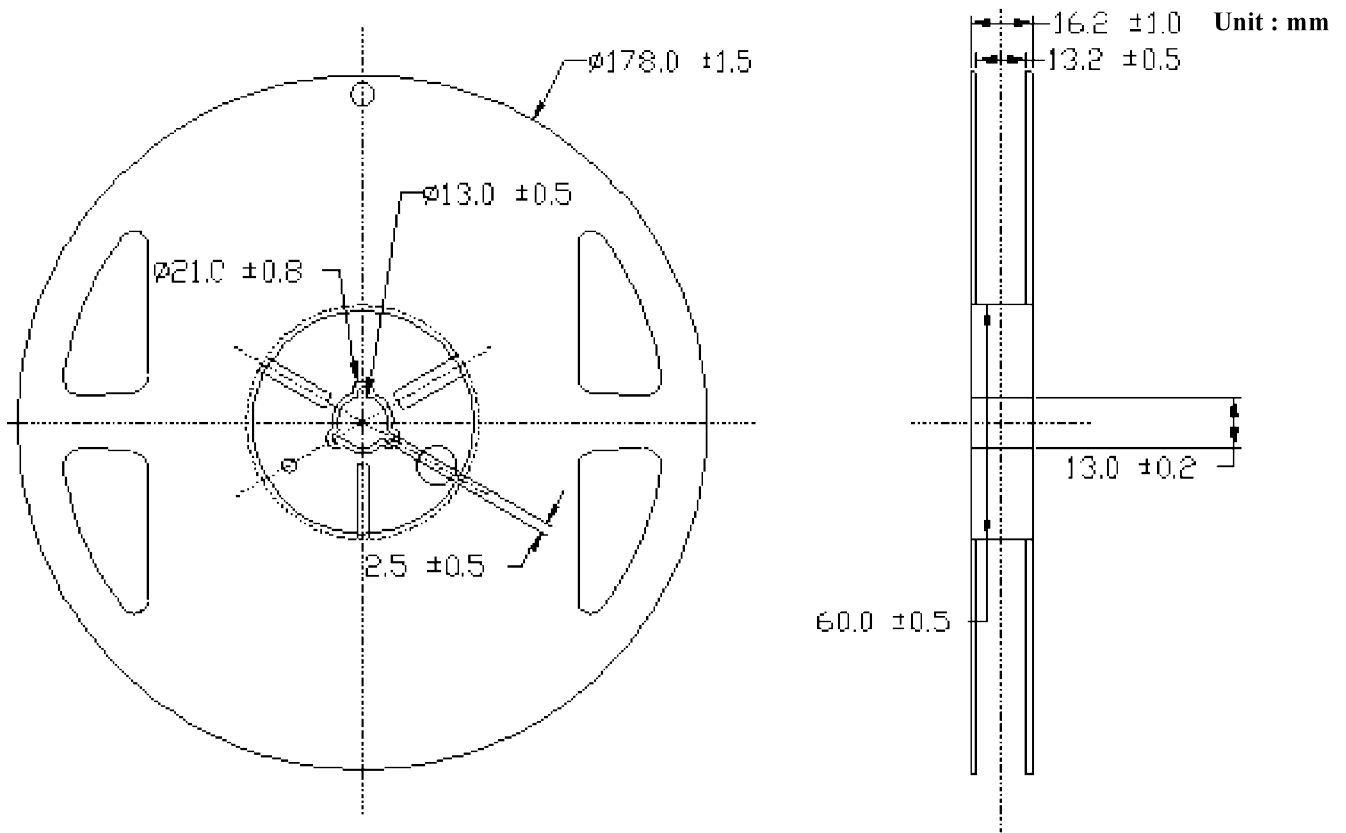

The information in this document is subject to change without notice.

Anti Statistic Bag :

Unit : mm

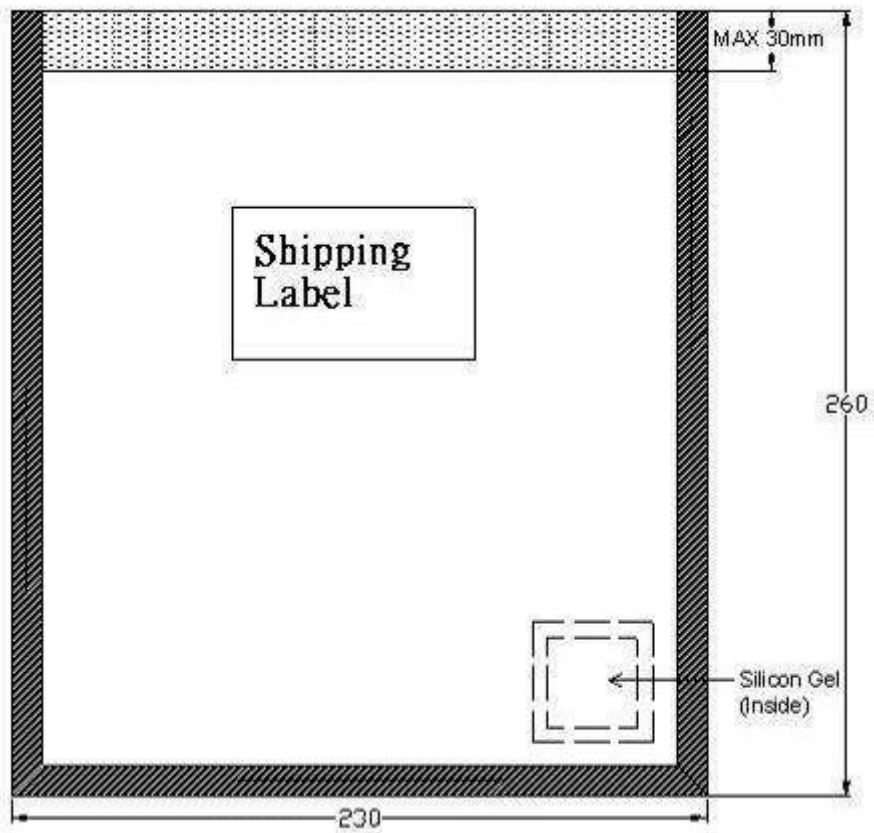

Small Box

Unit : mm

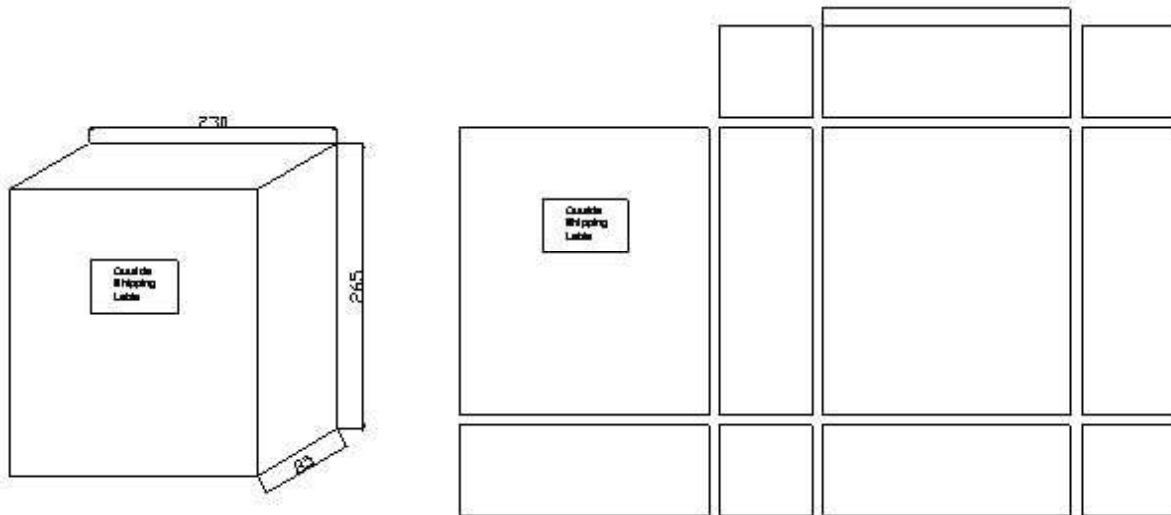

Middle Box

Unit : mm

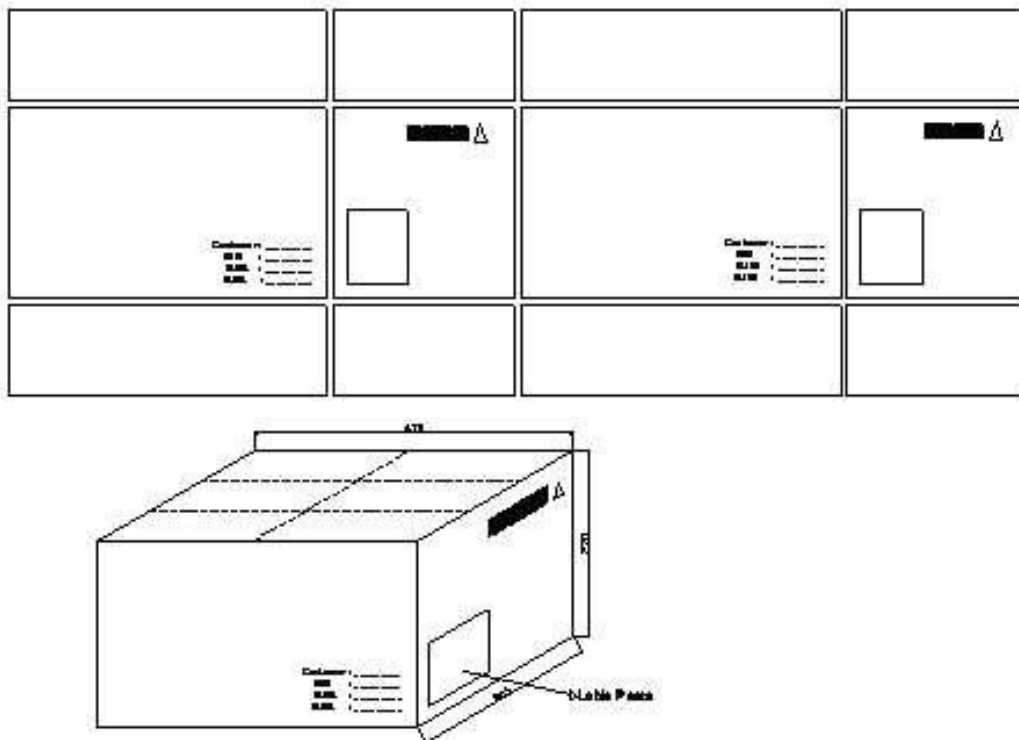

Large Box

Unit : mm

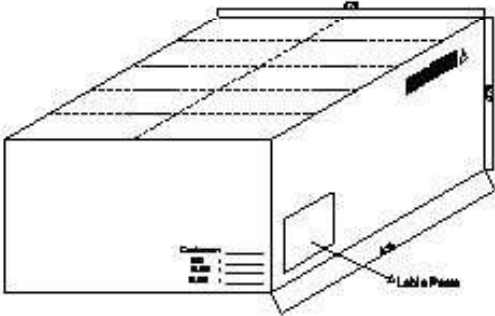
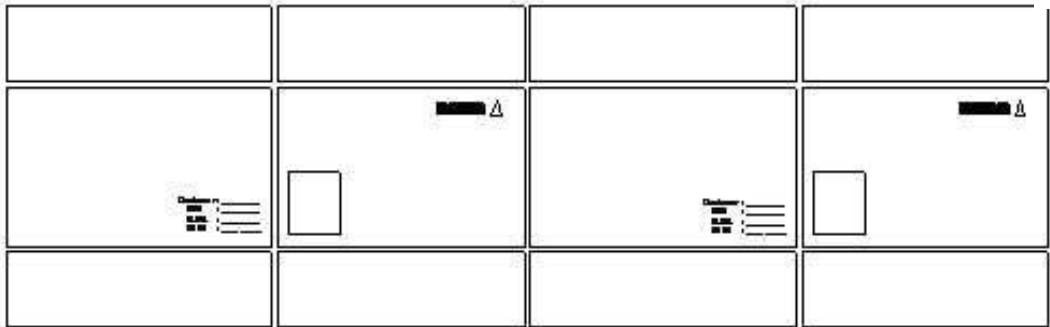

Recommended Solder Profile

Soldering Recommended soldering conditions:

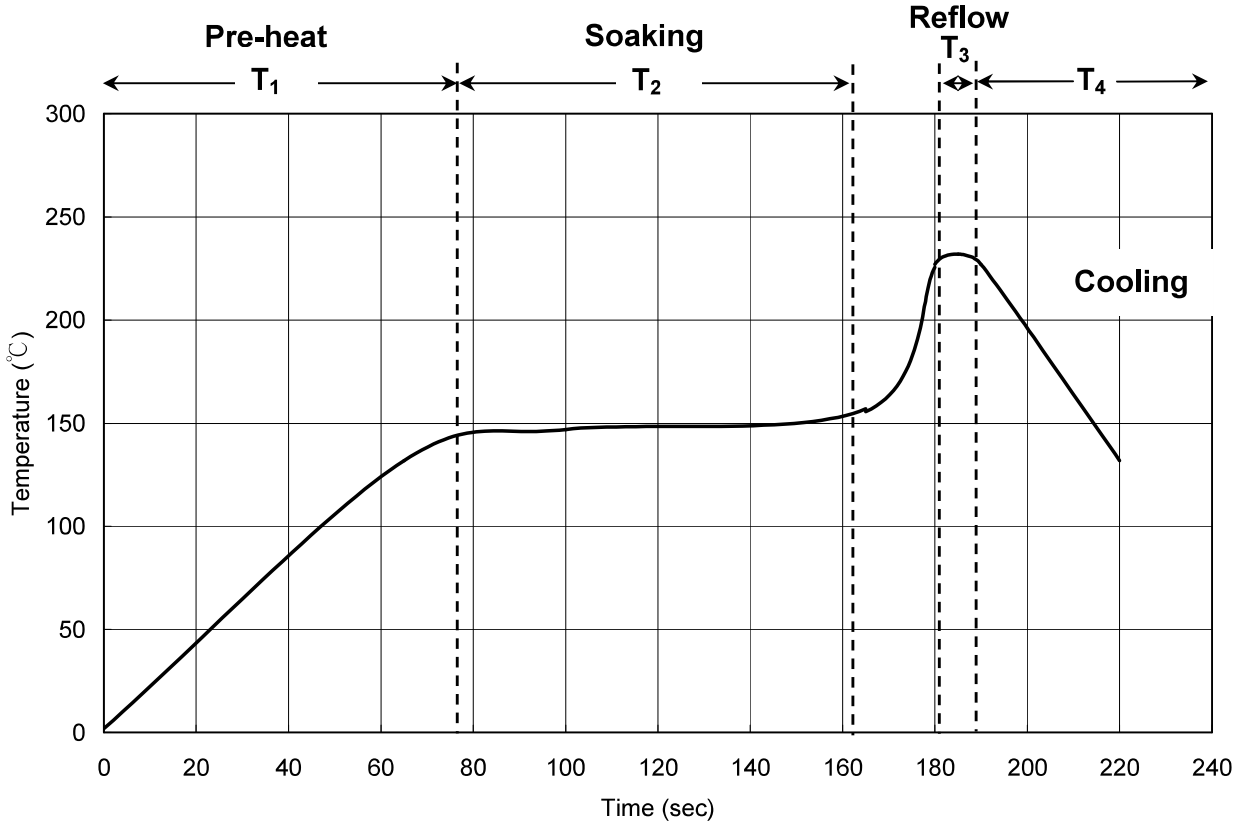

T ₁	Ramp up rate	1.0 ~ 3.0 °C/sec
	Pre-heat time	50 ~ 80 sec
T ₂	Soaking temperature	155 ~ 185 °C
	Dwell time during soaking	60 ~ 120 sec
T ₃	Reflow temperature	220 ~ 230 °C
	Reflow time	Max 10 sec
	Ramp up rate during reflow	1.2 ~ 2.3 °C/sec
T ₄	Cooling	1.0 ~ 6.0 °C/sec

Note: Suggest using Sn96Ag3Cu0.5 lead free solder.

Cleaning

Use alcohol-based cleaning solvents such as isopropyl alcohol to clean the LED if necessary.