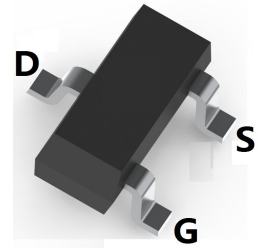
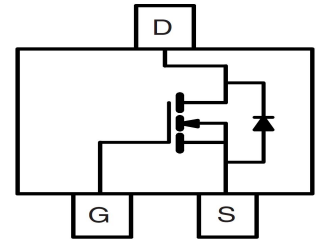

**LOW VOLTAGE MOSFET (N-CHANNEL)**
**FEATURES**

- Low on-resistance:  $V_{DS}=100V$ ,  $R_{DS(ON)} \leq 280m\Omega @ V_{GS}=10V, I_D=2A$
- For Low power DC to DC converter application
- For Load switch application
- Surface Mount device

**SOT-23**

**MECHANICAL DATA**

- Case: SOT-23
- Case Material: Molded Plastic. UL flammability
- Classification Rating: 94V-0
- Weight: 0.008 grams (approximate)

**MAXIMUM RATINGS ( $T_A = 25^\circ C$  unless otherwise noted)**

Parameter	Symbol	Value	Unit
Drain-source voltage	$V_{DS}$	100	V
Gate-source voltage	$V_{GS}$	$\pm 20$	V
Continuous drain current	$I_D$	2	A
Pulsed drain current (Note 1)	$I_{DM}$	8	A
Power dissipation	$P_D$	1.2	W
Thermal resistance from Junction to ambient	$R_{\theta JA}$	105	$^\circ C/W$
Junction temperature	$T_J$	150	$^\circ C$
Storage temperature	$T_{STG}$	-55 ~ +150	$^\circ C$

**ELECTRICAL CHARACTERISTICS ( $T_A = 25^\circ C$  unless otherwise specified)**

Parameter	Symbol	Min	Typ	Max	Unit	Conditions
Drain-Source breakdown voltage	$V_{(BR)DSS}$	100			V	$V_{GS}=0V, I_D=250\mu A$
Zero gate voltage drain current	$I_{DSS}$			1	$\mu A$	$V_{DS}=60V, V_{GS}=0V$
Gate-body leakage current	$I_{GSS}$			$\pm 100$	nA	$V_{DS}=0V, V_{GS}=\pm 20V$
Gate-threshold voltage (note 1)	$V_{GS(th)}$	1.1		3.0	V	$V_{DS}=V_{GS}, I_D=250\mu A$
Drain-source on-resistance (note 1)	$R_{DS(ON)}$		250	280	m $\Omega$	$V_{GS}=10V, I_D=3A$
			260	310	m $\Omega$	$V_{GS}=4.5V, I_D=3A$
Forward transconductance (note 1)	$g_{FS}$	1.4			S	$V_{DS}=15V, I_D=2A$
Input capacitance	$C_{iss}$		330		pF	$V_{DS}=50V, V_{GS}=0V, f=1MHz$
Output capacitance	$C_{oss}$		88		pF	
Reverse transfer capacitance	$C_{rss}$		17		pF	
Turn-on delay time	$t_{d(on)}$		14		nS	$V_{DD}=50V, V_{GS}=10V, R_{GEN}=1\Omega, I_D=1.3A$
Turn-on rise time	$t_r$		54		nS	
Turn-off delay time	$t_{d(off)}$		18		nS	
Turn-off fall time	$t_f$		10		nS	
Total gate charge	$Q_g$		5.3		nC	$V_{DS}=50V, V_{GS}=4.5V, I_D=3A$
Gate-source charge	$Q_{gs}$		1.4		nC	
Gate-drain charge	$Q_{gd}$		1.3		nC	
Diode forward voltage (note 1)	$V_{SD}$			1.2	V	$I_S=2A, V_{GS}=0V$

Note: 1. Pulse test: Pulse width  $\leq 300\mu s$ , Duty cycle  $\leq 2\%$ .

LOW VOLTAGE MOSFET (N-CHANNEL)

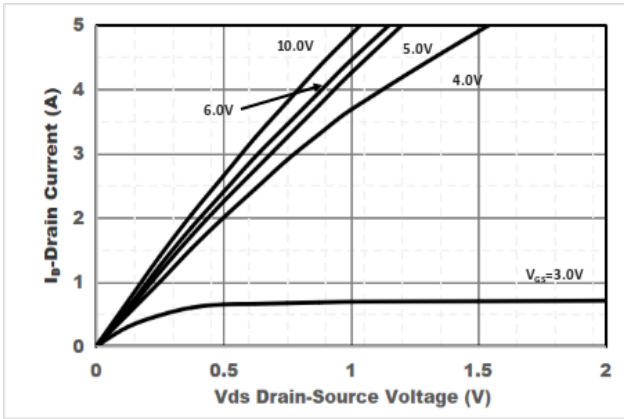

Figure1. Output Characteristics

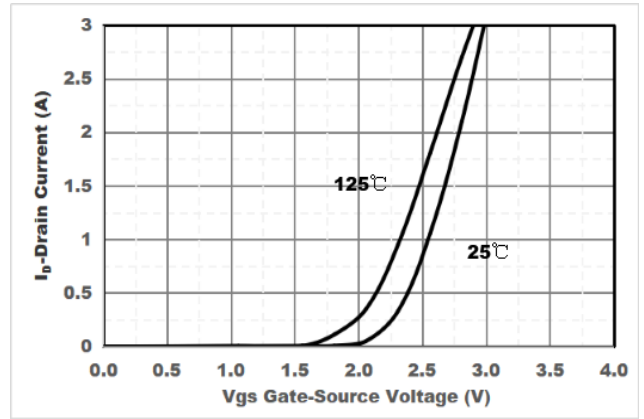

Figure2. Transfer Characteristics

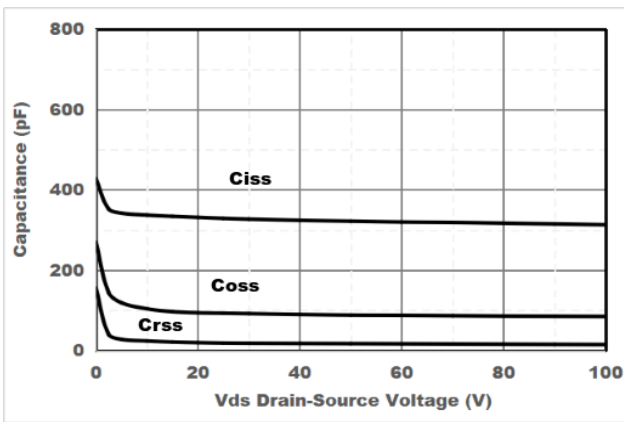

Figure3. Capacitance Characteristics

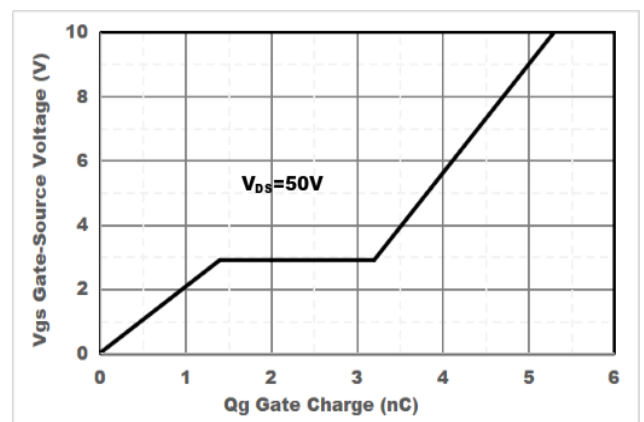

Figure4. Gate Charge

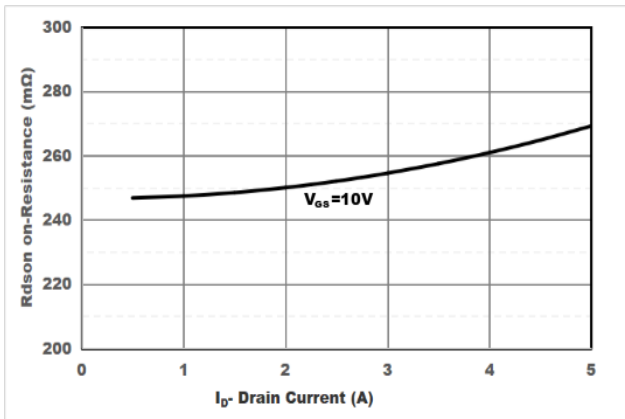

Figure5. Drain-Source on Resistance

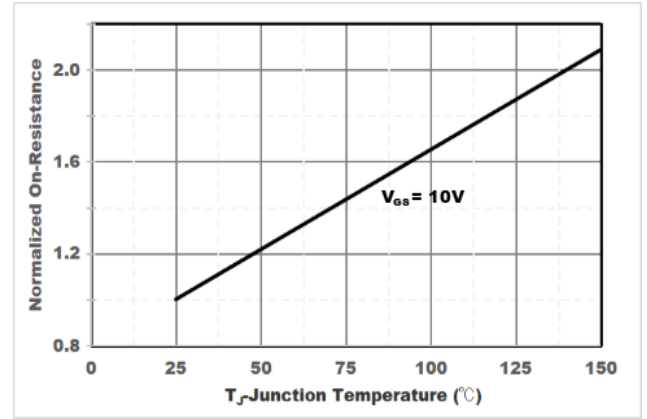

Figure6. Drain-Source on Resistance

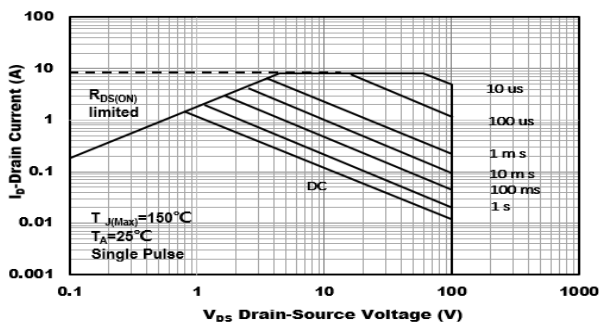

Figure7. Safe Operation Area

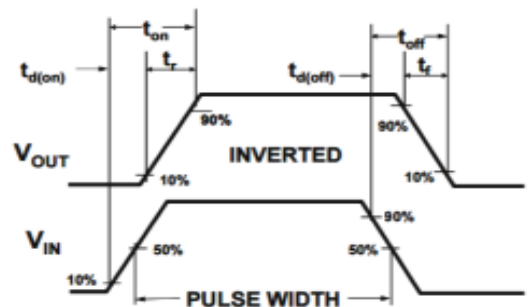
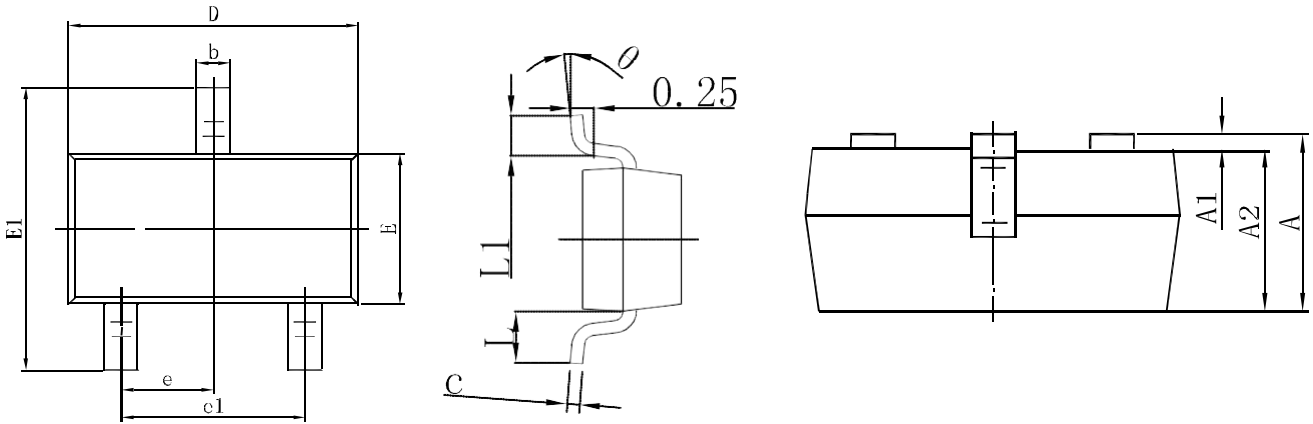

Figure8. Switching wave

LOW VOLTAGE MOSFET (N-CHANNEL)

SOT-23 Package Outline Dimensions



Symbol	Dimensions In Millimeters		Dimensions In Inches	
	Min.	Max.	Min.	Max.
A	0.900	1.150	0.035	0.045
A1	0.000	0.100	0.000	0.004
A2	0.900	1.050	0.035	0.041
b	0.300	0.500	0.012	0.020
c	0.080	0.150	0.003	0.006
D	2.800	3.000	0.110	0.118
E	1.200	1.400	0.047	0.055
E1	2.250	2.550	0.089	0.100
e	0.950 TYP		0.037 TYP	
e1	1.800	2.000	0.071	0.079
L	0.550 REF		0.022 REF	
L1	0.300	0.500	0.012	0.020
θ	0°	8°	0°	8°

SOT-23 Suggested Pad Layout

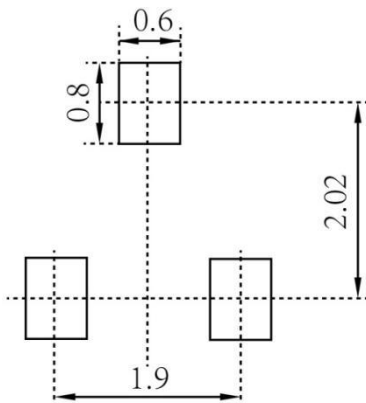

**Note:**

1. Controlling dimension: in millimeters
2. General tolerance:  $\pm 0.05\text{mm}$
3. The pad layout is for reference purposes only

LOW VOLTAGE MOSFET (N-CHANNEL)

**SOT-23 Tape and Reel**

**SOT-23 Embossed Carrier Tape**

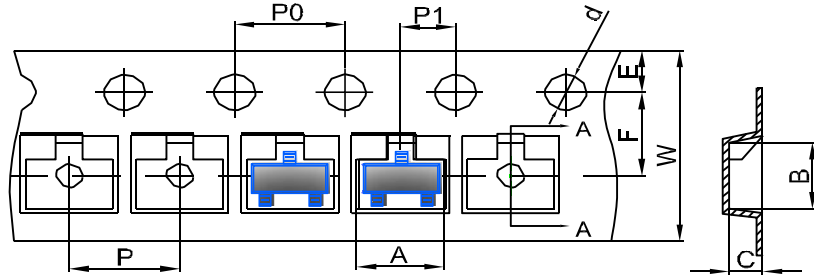

DIMENSIONS ARE IN MILLIMETER										
TYPE	A	B	C	d	E	F	P0	P	P1	W
SOT-23	3.15	2.77	1.22	Ø1.50	1.75	3.50	4.00	4.00	2.00	8.00
TOLERANCE	±0.1	±0.1	±0.1	±0.1	±0.1	±0.1	±0.1	±0.1	±0.1	±0.1

**SOT-23 Tape Leader and Trailer**

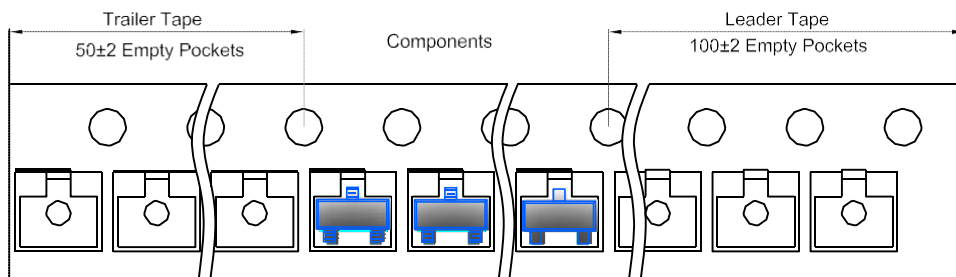

**SOT-23 Reel**

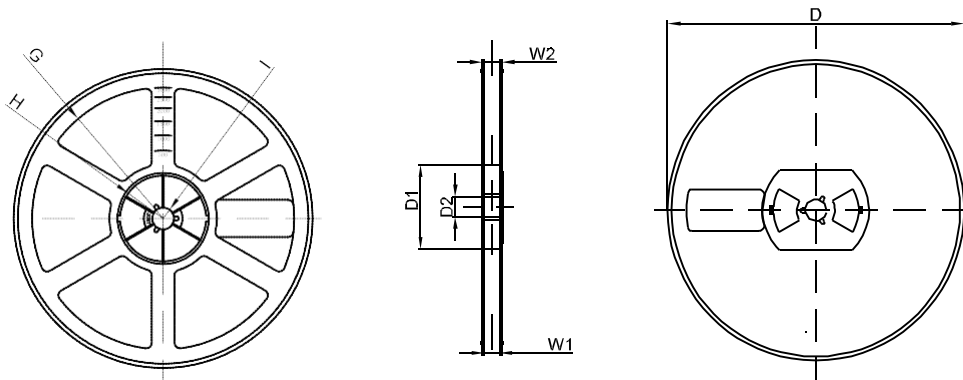

DIMENSIONS ARE IN MILLIMETER								
REEL OPTION	D	D1	D2	G	H	I	W1	W2
7" DIA	Ø178	54.40	13.00	R78	R25.60	R6.50	9.50	12.30
TOLERANCE	±2	±1	±1	±1	±1	±1	±1	±1