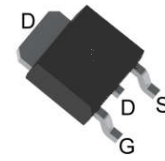
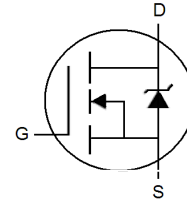

N-CHANNEL Power MOSFET
FEATURES

- $V_{DS}=30V, R_{DS(ON)} \leq 8.5m\Omega @ V_{GS}=10V, I_D=20A$
- Ultra Low on-resistance
- For Low power DC to DC converter application
- For Load switch application
- Surface Mount device

TO-252
MECHANICAL DATA

- Case: TO-252
- Case material: Molded Plastic. UL flammability 94V-0
- Weight: 0.33grams (approximate)

EQUIVALENT CIRCUIT
MAXIMUM RATINGS ($T_A = 25^\circ\text{C}$ unless otherwise noted)

Symbol	Parameter	Rating	Units
V_{DS}	Drain-Source Voltage	30	V
V_{GS}	Gate-Source Voltage	± 20	V
$I_D @ T_C=25^\circ\text{C}$	Continuous Drain Current ¹	50	A
$I_D @ T_C=100^\circ\text{C}$	Continuous Drain Current ¹	30	A
I_{DM}	Pulsed Drain Current ²	112	A
EAS	Single Pulse Avalanche Energy ³	24	mJ
I_{AS}	Avalanche Current	22	A
$P_D @ T_C=25^\circ\text{C}$	Total Power Dissipation ⁴	37	W
T_{STG}	Storage Temperature Range	-55 to 150	$^\circ\text{C}$
T_J	Operating Junction Temperature Range	-55 to 150	$^\circ\text{C}$

ELECTRICAL CHARACTERISTICS ($T_A = 25^\circ\text{C}$ unless otherwise specified)

Symbol	Parameter	Conditions	Min.	Typ.	Max.	Unit
BV_{DSS}	Drain-Source Breakdown Voltage	$V_{GS}=0V, I_D=250\mu\text{A}$	30	---	---	V
$R_{DS(ON)}$	Static Drain-Source On-Resistance ²	$V_{GS}=10V, I_D=20A$		6.8	8.5	$m\Omega$
		$V_{GS}=4.5V, I_D=20A$		9.3	14	$m\Omega$
$V_{GS(th)}$	Gate Threshold Voltage	$V_{GS}=V_{DS}, I_D=250\mu\text{A}$	1.0	1.5	3.0	V
I_{DSS}	Drain-Source Leakage Current	$V_{DS}=30V, V_{GS}=0V, T_J=25^\circ\text{C}$	---	---	1	μA
		$V_{DS}=24V, V_{GS}=0V, T_J=125^\circ\text{C}$	---	---	10	
I_{GSS}	Gate-Source Leakage Current	$V_{GS}=\pm 20V, V_{DS}=0V$	---	---	± 100	nA
R_g	Gate Resistance	$V_{DS}=0V, V_{GS}=0V, f=1\text{MHz}$	---	1.8	---	Ω
Q_g	Total Gate Charge (10V)	$V_{DS}=15V, V_{GS}=10V, I_D=20A$	---	9.8	---	nC
Q_{gs}	Gate-Source Charge		---	4.2	---	
Q_{gd}	Gate-Drain Charge		---	3.6	---	
$T_{d(on)}$	Turn-On Delay Time	$V_{DD}=15V, V_{GS}=10V, R_G=3\Omega, I_D=15A$	---	4	---	ns
T_r	Rise Time		---	8	---	
$T_{d(off)}$	Turn-Off Delay Time		---	30	---	
T_f	Fall Time		---	4	---	
C_{iss}	Input Capacitance	$V_{DS}=15V, V_{GS}=0V, f=1\text{MHz}$	---	940	---	pF
C_{oss}	Output Capacitance		---	130	---	
C_{rss}	Reverse Transfer Capacitance		---	110	---	

N-CHANNEL Power MOSFET

TYPICAL CHARACTERISTICS

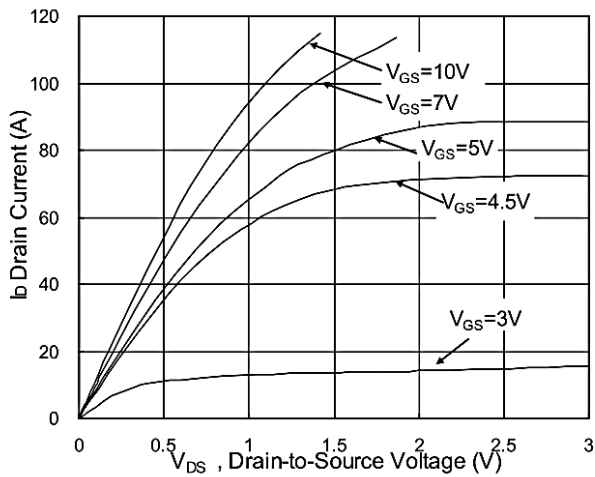

Fig.1 Typical Output Characteristics

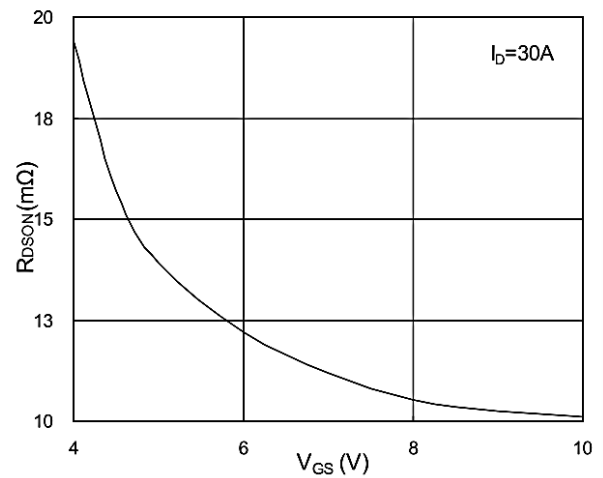

Fig.2 On-Resistance vs. G-S Voltage

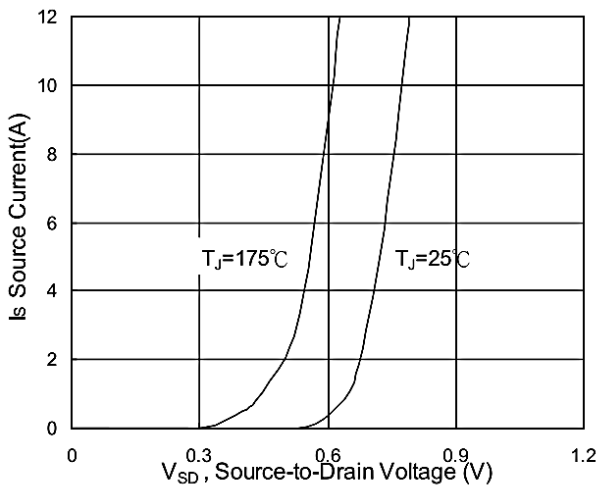

Fig.3 Forward Characteristics of Reverse

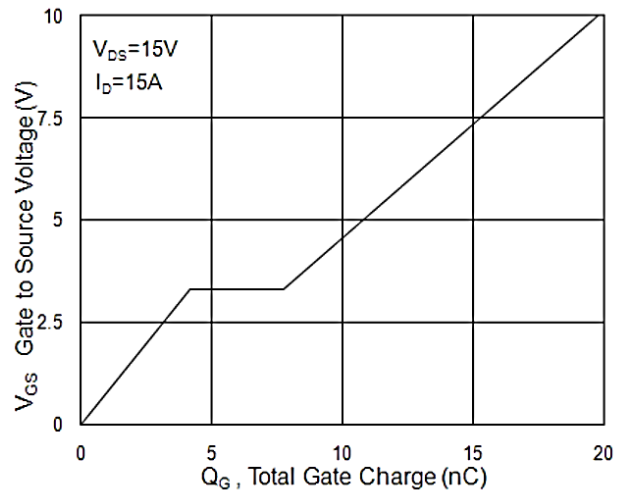

Fig.4 Gate-Charge Characteristics

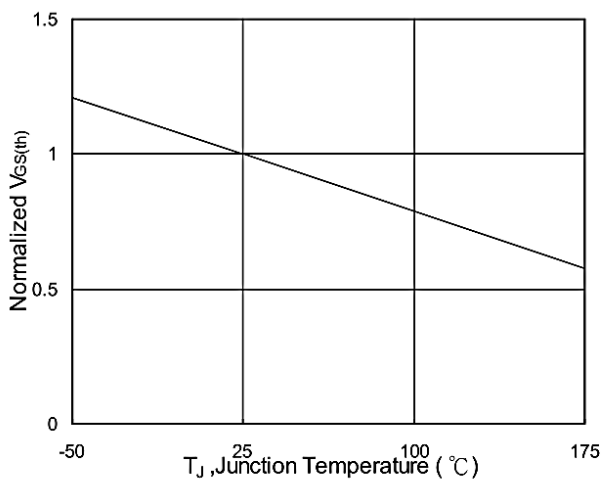

Fig.5 Normalized $V_{GS(th)}$ vs. T_J

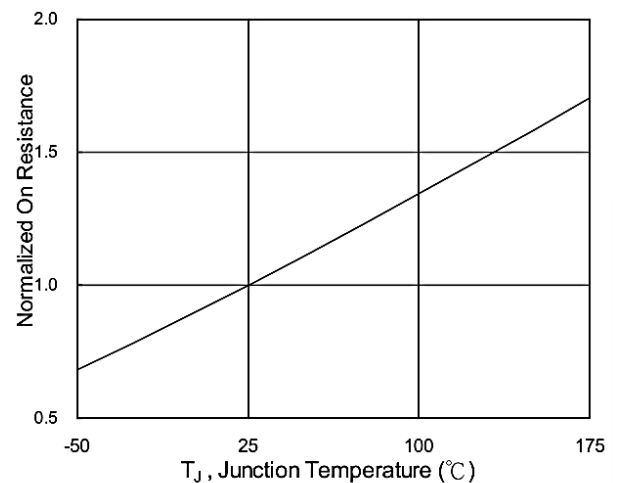

Fig.6 Normalized $R_{DS(on)}$ vs. T_J

N-CHANNEL Power MOSFET

Typical Characteristics

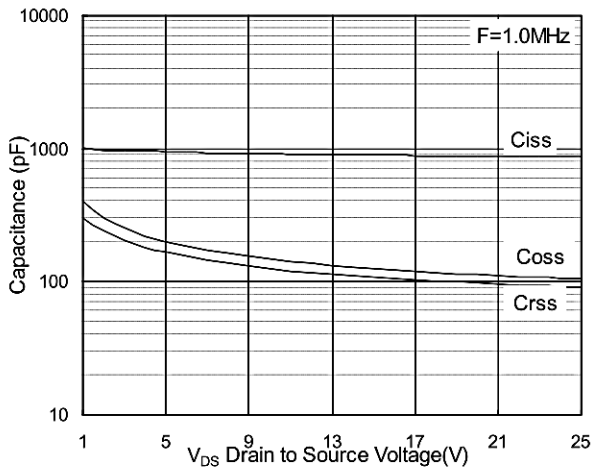

Fig.7 Capacitance

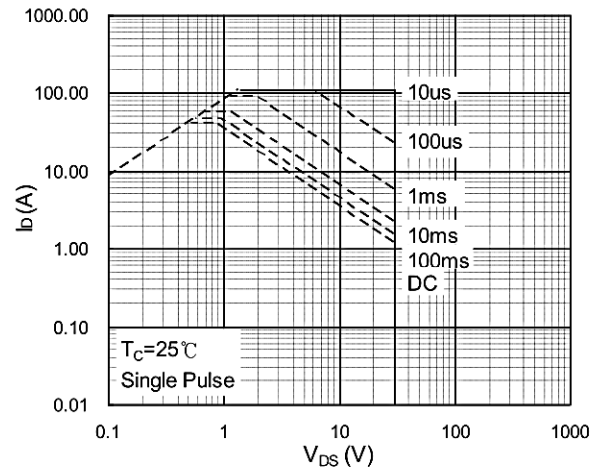

Fig.8 Safe Operating Area

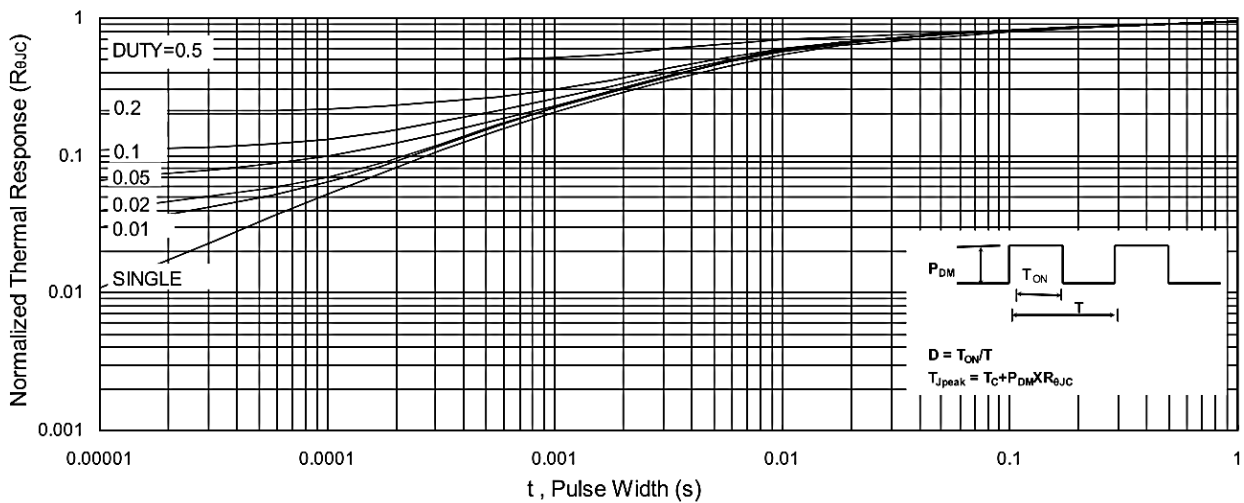

Fig.9 Normalized Maximum Transient Thermal Impedance

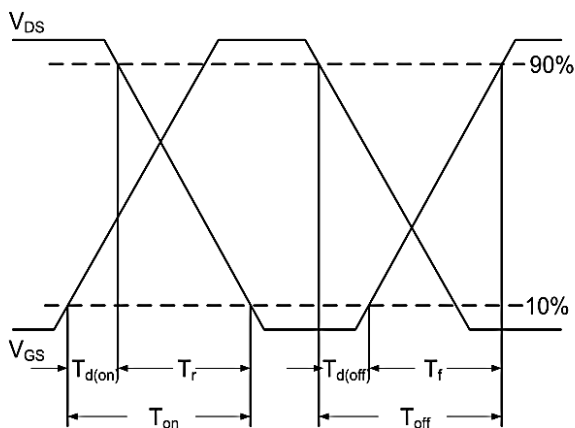

Fig.10 Switching Time Waveform

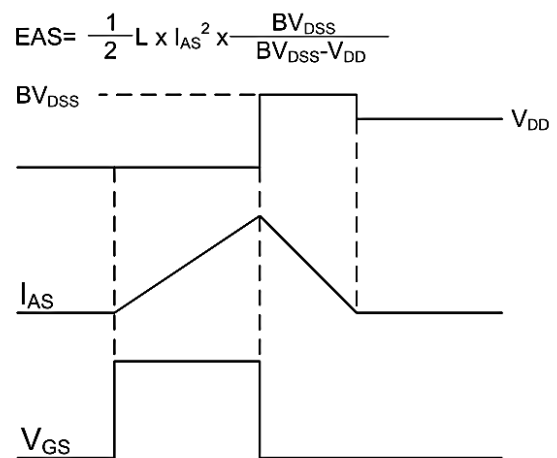
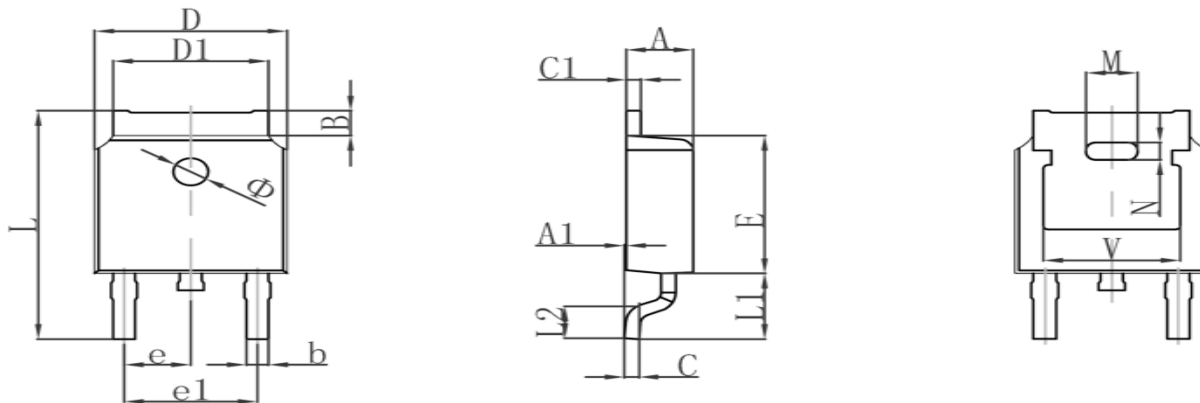

Fig.11 Unclamped Inductive Switching Waveform

N-CHANNEL Power MOSFET

TO-252 PACKAGE OUTLINE DIMENSIONS



Symbol	Dimensions In Millimeters		Dimensions In Inches	
	Min.	Max.	Min.	Max.
A	2.200	2.380	0.087	0.094
A1	0.000	0.100	0.000	0.004
B	0.800	1.400	0.031	0.055
b	0.710	0.810	0.028	0.032
c	0.460	0.560	0.018	0.022
c1	0.460	0.560	0.018	0.022
D	6.500	6.700	0.256	0.264
D1	5.130	5.460	0.202	0.215
E	6.000	6.200	0.236	0.244
e	2.286TYP		0.090TYP	
e1	4.327	4.727	0.170	0.186
M	1.778REF		0.070REF	
N	0.762REF		0.018REF	
L	9.800	10.400	0.386	0.409
L1	2.9REF		0.114REF	
L2	1.400	1.700	0.055	0.067
V	4.830REF		0.190REF	
Φ	1.100	1.300	0.043	0.051

TO-252 SUGGESTED PAD LAYOUT

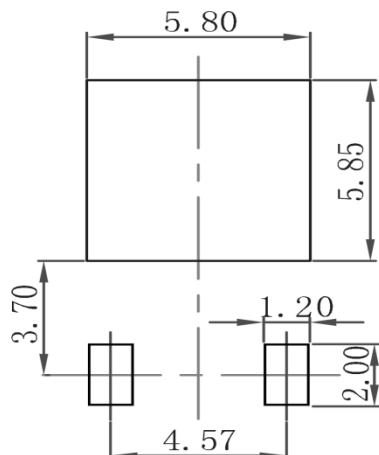

Note:

1. Controlling dimension: in millimeters
2. General tolerance: $\pm 0.05\text{mm}$
3. The pad layout is for reference purposes only

N-CHANNEL Power MOSFET

TO-252 TAPE AND REEL

TO-252 Embossed Carrier Tape

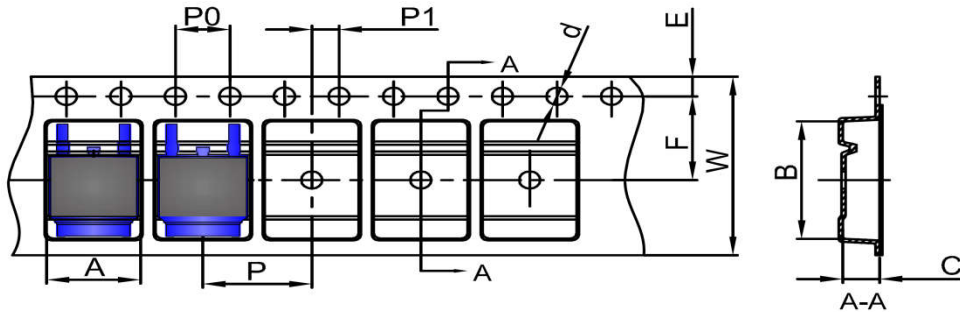

DIMENSIONS ARE IN MILLIMETER										
TYPE	A	B	C	d	E	F	P0	P	P1	W
TO-252	6.90	10.50	2.70	Ø1.55	1.75	7.50	4.00	8.00	2.00	16.00
TOLERANCE	±0.1	±0.1	±0.1	±0.1	±0.1	±0.1	±0.1	±0.1	±0.1	±0.1

TO-252 Tape Leader and Trailer

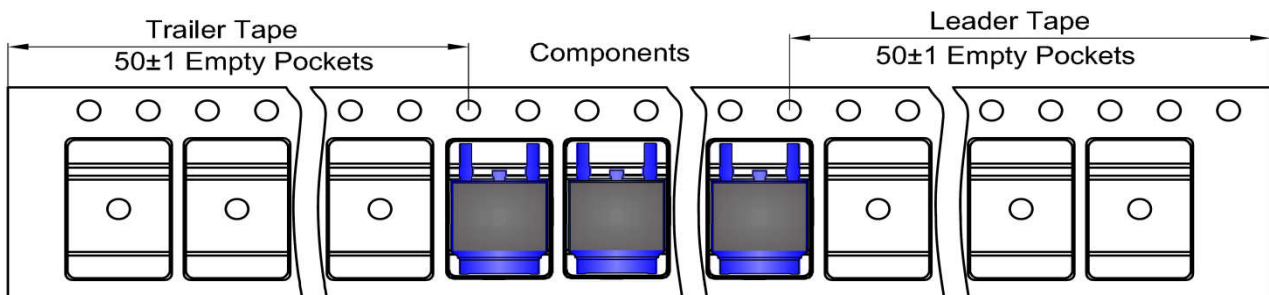

TO-252 REEL

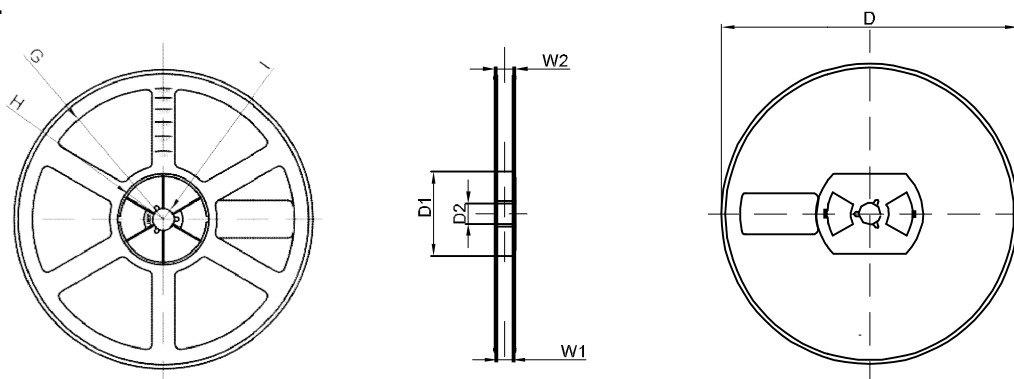

DIMENSIONS ARE IN MILLIMETER								
REEL OPTION	D	D1	D2	G	H	I	W1	W2
13" DIA	Ø330.00	100.00	Φ21.00	R151.00	R56.00	R6.50	16.40	21.00
TOLERANCE	±2	±1	±1	±1	±1	±1	±1	±1